



**Built-in Household
Appliances**
2017-2018

VESTEL



I N D E X



COMPANY PROFILE
02-03



GLOBAL OPERATIONS
04-05



REFRIGERATORS
06-16



60 CM DISHWASHERS
17 - 47

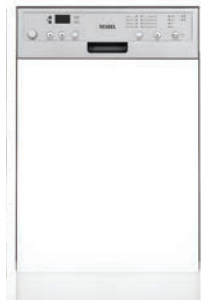

45 CM DISHWASHERS
49 - 62



OVENS
63 - 107



HOBS
108 - 170



SPECIFICATIONS
171 - 216



VESTEL

COMPANY PROFILE

Vestel City, which comprises nine plants located in Manisa, is amongst the biggest industrial complexes of the world.



1.100.000 m²
Closed Production Area



16.000
Employees



18 Million
TV Production Capacity



10,9 Million
Home Appliances
Production Capacity



35 Million
Device Production
Capacity



\$ 4 Billion
Turnover



Export Leader of Turkey with
\$ 2.5 Billion



Vestel City, which comprises nine plants located in Manisa, is amongst the biggest industrial complexes of the world.

As one of the leading enterprises in Turkey, Vestel is a major player in consumer electronics, mobile technologies, household appliances, professional displays and LED lighting with renowned products, including refrigerators, washing machines, cooking appliances, dishwashers, air conditioners, water heaters, television sets, educational, hospitality and digital signage solutions, digital set-top boxes, tablet PCs, and smart phones.

The company is recognised for its cutting-edge designs, high product quality, large production capacity, and superior market share growth.

Vestel is one of the ten biggest household appliance manufacturers in Europe, with its new product development ability, flexibility in

production, and fast response to clients' demands.

Operating with an annual capacity of 3.2 million units, the company's two refrigerator plants produce a variety of models ranging from french door, no-frost, combi, double door, single door, to table top fridges and freezers, as well as built-in models.

Achieving similar success with washing machines, Vestel is able to produce 2.5 million units a year, with models ranging from 4 kg to 9 kg drum capacities. The group added washer dryers to the product range in 2012. The plant for cooking appliances operates with an annual capacity of 2.2 million units, producing free-standing cookers, built-in hobs and ovens.

The household appliances product range includes free standing, semi and fully integrated dishwashers. The plant has the capacity to produce 2.5 million units a year.

In addition, the air conditioner factory is capable of producing 750,000 units of split-type models.

Vestel is the first company in Turkey operating two manufacturing plants in Russia for the production of refrigerators, washing machines, and televisions with the aim of becoming a leader in CIS countries.

Vestel Trade, the company responsible for the marketing and sales of Vestel products overseas, exports 73% percent of its production under leading Japanese and European brands to 155 countries.

Vestel Trade has achieved export sales of 8.3 million units of electronics and 4.8 million units of household appliances.

Distributing its products to seven continents, Vestel takes its place as a world-class company.





GLOBAL OPERATIONS



Manufacturing & Assembly Plants

LED TV, HD, IP/OTT, PVR Set-top Boxes – Manisa, Turkey

Professional Displays, Tablet PC, Smart Phone, LED lighting – Manisa Turkey

Refrigerator, Washing Machine, Dishwasher, Tumble Dryer, Cooking Appliances, Air Conditioner, Water Heater – Manisa, Turkey



Marketing & Sales Companies

Vestel Trade, Turkey

Vestel France, France

Vestel Germany, Germany

Vestel UK, The UK

Vestel Iberia, Spain

Gruppo Industriale Vesit, Italy

Vestel Benelux, The Netherlands

Vestel CIS Ltd, Russia

Vestel Electronica, Romania

Vestel Scandinavia, Finland

Vestfrost Household, Denmark

Vestel Central Asia, Kazakhstan



R&D Centers

Manisa, Turkey

Istanbul, Turkey

Bristol, UK

Shangai, China

REFRIGERATORS





DOOR ON DOOR MODELS

Cabinet door is mounted directly onto the refrigerator door and with the help of the hinge, the refrigerator opens wider and closes automatically.



SLIDING DOOR MODELS

Cabinet door is Connected to the refrigerator door with sliding rails.



REVERSIBLE DOORS

All Vestel refrigerator doors can be opened to the left or right with a simple adjustment.

Wire shelves and opaque white accessories are also available for all models.



SAFETY GLASS

Glass shelves are made of safety glass and can hold upto 20 kg in weight.



REMOVABLE MAGNETIC GASKET

The gasket prevents growth of bacteria and microorganisms.

STAR RATING **★★★★**

All Vestel freezers have 4 star rating which allows you to safely freeze fresh food and deeply store frozen food.



EASY LOCK FREEZER

Mechanism of the handle enables easy opening and closing of the door.

Red mark on the door indicates and warns the user when the freezer door is left open.



CONTROL PANEL

Warning lights advise current freezer status and internal temperature rise.

Quick Service Control Box Thermostat and other controls are easily reachable for service purposes.

ENERGY EFFICIENCY

Vestel built-in fridges and freezers are available with or A++, A+ or A energy class.

BGST/SN 2795 BGT/SN 2795



BUILT-IN SINGLE DOOR

Niche 1780mm
Sliding door
Door on Door
Reversible doors

FRIDGE

Turbo fan air cooling
Air Duct
Safety Glass Shelves
1 Glass Shelf over Crisper
2 Crispers
Automatic Defrosting
Humidity Controller

TECHNICAL DATA

Energy Class: A++/A+
Gross/Net Volume: 303 lt/300 lt
Product Dimensions (HxWxD):
1770 x 540 x 545

INDOOR FEATURES

1 Dairy Rack
1 Egg Holder
3 Transparent shelves
1 Bottle Shelf

OPTIONAL FEATURES

Electronic Head Panel Display
LED Lighting
Wine Shelf
Adjustable Door Rack
MaxiFresh Preserver
Touch button head panel



BUILT-IN SINGLE DOOR

Niche 1780mm
Sliding door
Door on Door
Reversible doors

FRIDGE

Energy Class: A++/A+
Gross/Net Volume: 221lt/197lt
Product Dimensions (HxWxD):
1770 x 540 x 545

TECHNICAL DATA

Energy Class: A++/A+
Gross/Net Volume: 303 lt/300 lt
Product Dimensions (HxWxD):
1770 x 540 x 545

INDOOR FEATURES

4 star freezer
6 Freezer Compartments + 2 Flap
Automatic Defrosting
LED Lighting

OPTIONAL FEATURES

Sliding Icematic
Touch button head panel



BGST/SN 2791 BGT/SN 2791



BGST/SN 2761 BGT/SN 2761



BUILT-IN SINGLE DOOR

Niche 1780mm, Sliding door
Door on Door, Reversible doors

FREEZER

Turbo fan air cooling
Air Duct
Safety Glass Shelves
1 Glass Shelf over Crisper
2 Crispers
Automatic Defrosting
Humidity Controller

FRIDGE

Safety Glass Shelves
1 Glass Shelf over Crisper, 1 Crisper
Automatic Defrosting
Humidity Controller



INDOOR FEATURES

1 Dairy Rack, 1 Egg Holder
2 Transparent shelves, 1 Bottle Shelf

OPTIONAL FEATURES

Electronic Head Panel Display
LED Lighting (only for E models)
Wine Shelf
Adjustable Door Rack
MaxiFresh Preserver
Touch Button Head Panel

TECHNICAL DATA

Energy Class: A++/A+
Gross/Net Volume: 256 lt/243 lt
Net Frigde/Freezer Volume: 180 lt/163 lt
Product Dimensions (HxWxD):
1770 x 540 x 545

BUILT-IN SINGLE DOOR

Niche 1780mm, Sliding door
Door on Door, Reversible doors

FREEZER

4 star freezer, 1 Ice Box
3 Freezer Compartments

TECHNICAL DATA

Energy Class: A++/A+
Gross/Net Volume: 256 lt/251 lt
Net Frigde/Freezer Volume:
181 lt/170 lt
Product Dimensions (HxWxD):
1770 x 540 x 545

INDOOR FEATURES

1 Dairy Rack, 1 Egg Holder
2 Transparent shelves, 1 Bottle
Shelf

FRIDGE

Safety Glass Shelves
1 Glass Shelf over Crisper, 1
Crisper
Humidity Controller

OPTIONAL FEATURES

Wine Shelf
Adjustable Door Rack
MaxiFresh Preserver



BGST/SN 2760 BGT/SN 2760



DOUBLE DOOR

BGST/SN 2751 BGT/SN 2751



BUILT-IN SINGLE DOOR

Niche 1780mm, Sliding door
Door on Door, Reversible doors

FREEZER

Automatic Defrosting
4 star freezer, 1 Ice Box
4 Freezer Compartments

TECHNICAL DATA

Energy Class: A++/A+
Gross/Net Volume: 249 lt/233 lt
Net Frigde/Freezer Volume: 147 lt/186 lt
Product Dimensions (HxWxD):
1770 x 540 x 545



INDOOR FEATURES

1 Dairy Rack, 1 Egg Holder
2 Transparent shelves, 1 Bottle Shelf
Turbo Fan Air Cooling

FRIDGE

Safety Glass Shelves
1 Glass Shelf over Crisper, 1 Crisper
Automatic Defrosting
Humidity Controller

OPTIONAL FEATURES

Electronic Head Panel Display
LED Lighting (only for E models)
Wine Shelf
Adjustable Door Rack
MaxiFresh Preserver
Touch Button Head Panel

BUILT-IN SINGLE DOOR

Niche 1780mm, Sliding door
Door on Door, Reversible doors

FREEZER

4 star freezer, 1 Ice Box
4 Freezer Compartments

TECHNICAL DATA

Energy Class: A++/A+
Gross/Net Volume: 249 lt/242 lt
Net Frigde/Freezer Volume:
148 lt/194 lt
Product Dimensions (HxWxD):
1770 x 540 x 545

INDOOR FEATURES

1 Dairy Rack, 1 Egg Holder
1 Transparent Shelf, 1 Bottle Shelf

FRIDGE

Safety Glass Shelves
1 Glass Shelf over Crisper, 1
Crisper
Humidity Controller

OPTIONAL FEATURES

Wine Shelf
Adjustable Door Rack
MaxiFresh Preserver



BGST/SN 2750 BGT/SN 2750



BGN 3200



BUILT-IN SINGLE DOOR

Niche 1780 mm
Sliding Door
Door on Door also available BGN3200 D

FRIDGE

3 Removable Shelves
Spill Proof Safety Glass Shelves 1
Glass Shelf over Crisper
2 Crispers

TECHNICAL DATA

Energy Class: A+/A
Gross/Net Volume: 276 lt/261 lt
Net Fridge/Freezer Volume: 189 lt/72 lt
Product Dimensions (HxWxD):
1770 x 540 x 545 mm



INDOOR FEATURES

1 Dairy Rack with Transparent Cover
1 Egg Holder
2 Transparent Shelves
1 Bottle Shelves

FREEZER

**** Freezer
3 Freezer Compartment
1 Ice Box
Manual Defrost

BUILT-IN SINGLE DOOR

Niche 1450 mm
Sliding Door
Door on Door : BGN2610
DOD Reversible Doors

FRIDGE

3 Removable Shelves
Safety Glass Shelves
1 Glass Shelf over Crisper
2 Crispers

TECHNICAL DATA

Energy Class: A++/A+
Gross/Net Volume: 217 lt / 214 lt
Net Fridge/Freezer Volume: 176 lt / 38 lt
Product Dimensions (HxWxD):
1445 x 540 x 545 mm

INDOOR FEATURES

1 Dairy Rack
1 Egg Holder
2 Transparent Shelves
1 Bottle Shelf

FREEZER

**** Freezer
3 Freezer compartments
1 Ice Box



BGN 2610



SINGLE DOOR

BGN 2400



BUILT-IN SINGLE DOOR

Niche 1230 mm
Sliding Door
Door on Door: BGN2400
DOD Reversible Door

FRIDGE

* ** ** Freezer Compartment
Freezer Door Indicator
1 Ice Box
3 Removable Shelves
Safety Glass Shelves
1 Glass Shelf over Crisper
2 Crispers

TECHNICAL DATA

Energy Class: A++ / A+ / A
Gross / Net Volume: 195 lt / 192 lt
Net Fridge / Freezer Volume: 175 lt / 17 lt
Product Dimensions (HxWxD):
1225x540x545 mm

INDOOR FEATURES

1 Dairy Rack
1 Egg Holder
2 Transparent Shelves
1 Bottle Shelf



BUILT-IN SINGLE DOOR

Niche 1230 mm
Sliding Door
Door on Door: BGN2500
DOD Reversible Door

FRIDGE

4 Removable Shelves
Safety Glass Shelves
1 Glass Shelf over Crisper
2 Crispers

INDOOR FEATURES

1 Dairy Rack
1 Egg Holder
2 Transparent Shelves
1 Bottle Shelf

TECHNICAL DATA

Energy Class: A++ / A+ / A
Gross / Net Volume: 206 lt / 204 lt
Product Dimensions (HxWxD):
1225 x 540 x 545 mm

BGN 2500



BGN 1800



BUILT-IN SINGLE DOOR

Niche 1030 mm
Sliding Door
Door on Door: BGN1800
DOD Reversible Door

FRIDGE

* ** ** Freezer Compartment
Freezer Door Indicator
1 Ice Box
2 Removable Shelves
Safety Glass Shelves
1 Glass Shelf over Crisper
2 Crispers

TECHNICAL DATA

Energy Class: A++/A+/A
Gross/Net Volume: 153 lt/150 lt
Net Fridge/Freezer Volume: 133 lt/17 lt
Product Dimensions (HxWxD):
1020 x 540 x 545 mm

INDOOR FEATURES

1 Dairy Rack
1 Egg Holder
2 Transparent Shelves
1 Bottle Shelf



BUILT-IN SINGLE DOOR

Niche 1030 mm
Sliding Door
Door on Door: BGN1900
DOD Reversible Door

FRIDGE

3 Removable Shelves
Safety Glass Shelves
1 Glass Shelf over Crisper
2 Crispers

INDOOR FEATURES

1 Dairy Rack
1 Egg Holder
2 Transparent Shelves
1 Bottle Shelf

TECHNICAL DATA

Energy Class: A++/A+/A
Gross/Net Volume: 162 lt/160 lt
Product Dimensions (HxWxD):
1020 x 540 x 545 mm

BGN 1900



SINGLE DOOR

BGN 1400



BUILT-IN SINGLE DOOR

Niche 880 mm
Sliding Door
Door on Door: BGN1400
DOD Reversible Door

FRIDGE

* ** ** Freezer Compartment
Freezer Door Indicator
1 Ice Box
2 Removable Shelves
Safety Glass Shelves
1 Glass Shelf over Crisper
2 Crispers

INDOOR FEATURES

1 Dairy Rack
1 Egg Holder
1 Transparent Shelf
1 Bottle Shelf

TECHNICAL DATA

Energy Class: A++/A+/A Gross/Net
Volume: 126 lt/123 lt Net Fridge/
Freezer Volume:
106 lt/17 lt
Product Dimensions (HxWxD):
875 x 540 x 545 mm

BUILT-IN SINGLE DOOR

Niche 880 mm
Sliding Door
Door on Door: BGN1500
DOD Reversible Door

FRIDGE

3 Removable Shelves
Safety Glass Shelves
1 Glass Shelf over Crisper
2 Crispers

INDOOR FEATURES

1 Dairy Rack
1 Egg Holder
1 Transparent Shelves
1 Bottle Shelf

TECHNICAL DATA

Energy Class: A++/A+/A
Gross/Net Volume: 137 lt/136 lt
Product Dimensions (HxWxD):
875 x 540 x 545 mm

BGN 1500



BGN 1450



BUILT-IN SINGLE DOOR

Niche 880 mm
Sliding Door
Door on Door: BGN1450
DOD Reversible Door

FRIDGE

* ** ** Freezer
4 Freezer Compartments
1 Ice Box
Manual Defrost
Control Panel

TECHNICAL DATA

Energy Class: A++/A+/A Gross/Net
Volume: 109 lt/99 lt
Product Dimensions (HxWxD):
875 x 540 x 545 mm
Quick Freeze
Mains On
Temperature Rise Warning

BGN 1600 DOD



BUILT-IN SINGLE DOOR

Niche 820 mm
Door On Door
Reversible Door

FRIDGE

1 Removable Shelf
1 Glass Shelf over Crisper
1 Crisper
Safety Glass Shelves

INDOOR FEATURES

Energy Class: A+
Gross/Net Volume: 120 lt/115 lt
Product Dimensions (HxWxD):
818 x 595 x 548 mm

TECHNICAL DATA

1 Transparent Shelf
1 Egg Holder
1 Bottle Shelf

BUILT-IN SINGLE DOOR

Niche 820 mm
Door On Door
Reversible Door

FRIDGE

2 Removable Shelves
1 Glass Shelf over Crisper
1 Crisper
Spill Proof Safety Glass Shelves

INDOOR FEATURES

1 Transparent Shelf
1 Egg Holder
1 Bottle Shelf

TECHNICAL DATA

Energy Class: A+/A
Gross/Net Volume: 136 lt/133 lt
Product Dimensions (HxWxD):
818 x 595 x 548 mm

BGN 1700 DOD



BGN 1650 DOD



BUILT-IN SINGLE DOOR

Niche 820 mm
Door On Door
Reversible Door

TECHNICAL DATA

Energy Class: A+/A
Gross/Net Volume: 107 lt/93 lt
Product Dimensions (HxWxD):
818 x 595 x 548 mm

FRIDGE

******* Freezer
3 Freezer Compartments
1 Ice Box
Manual Defrost
Control Panel
Quick Freeze
Mains On
Temperature Rise Warning

INSTALLATIONS

***820-828 for metal top cover**

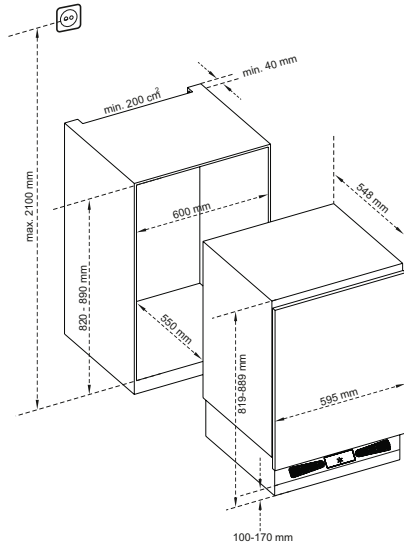

1600 / 1650 / 1700

***875-883 for metal top cover**

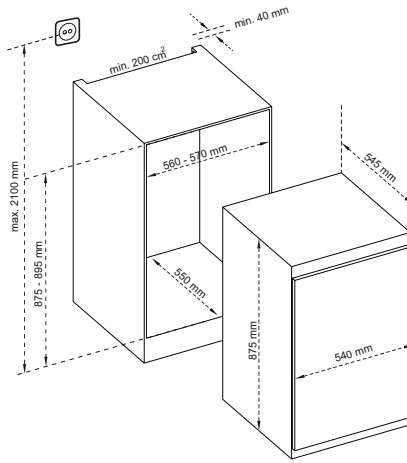

1400 / 1450 / 1500

***1020-1028 for metal top cover**

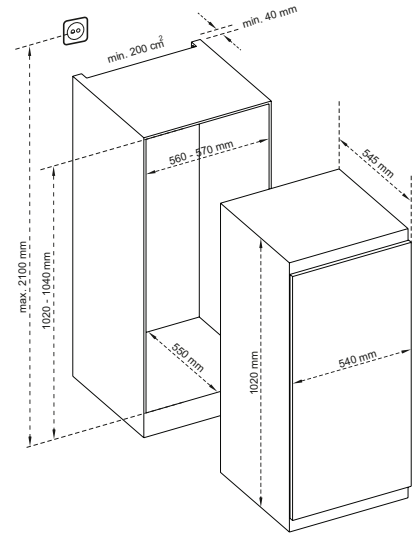

1800 / 1900

***1225-1233 for metal top cover**

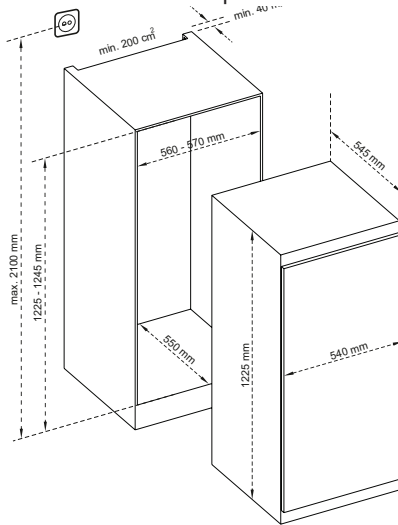

2400 / 2500

***1770-1778 for metal top cover**

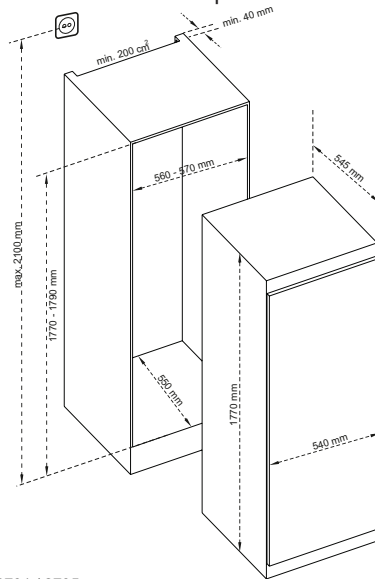

2791 / 2795

***1445-1453 for metal top cover**

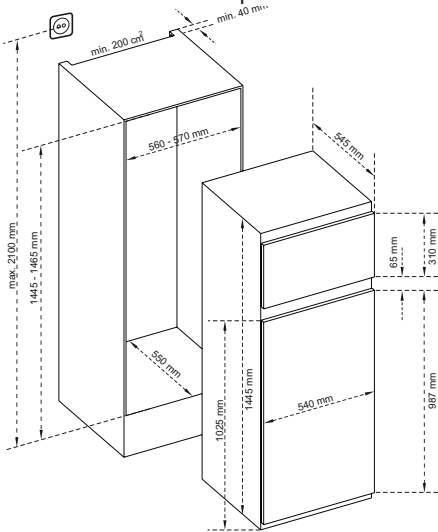

2610

***1770-1778 for metal top cover**

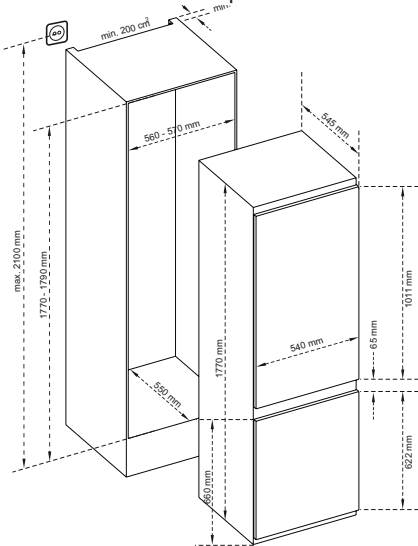

3200

***1770-1778 for metal top cover**

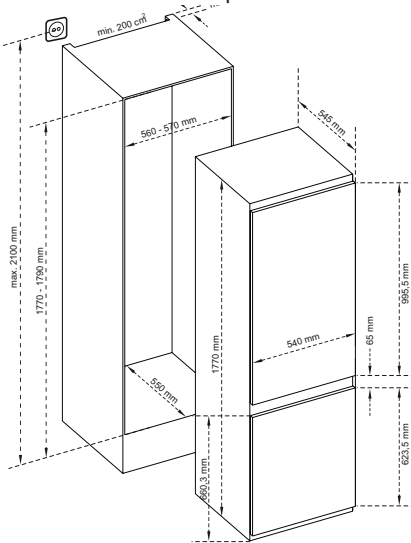

2760 / 2761

***1770-1778 for metal top cover**

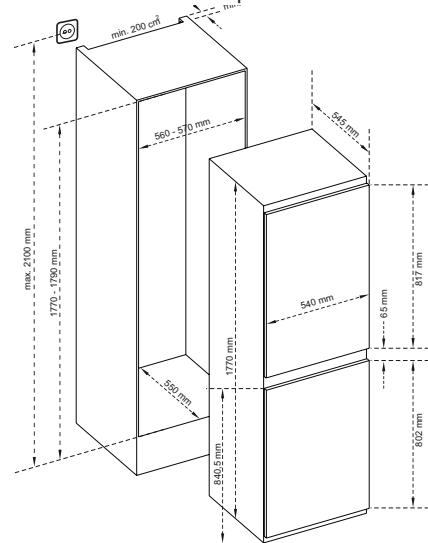

2750 / 2751

60 CM DISHWASHERS



FEATURES



Steam Wash

Steam wash technology softening the most stubborn dirt by steam power. High temperature and directly applied steam ensure perfect hygiene and gentle cleaning for your sensitive dishes.



Auto Programs With Turbidity Sensor

Turbidity sensor detects the amount of turbidity in water and adjusts the washing cycle parameters (temperature, duration, amount of water) accordingly.



Extra Drying

It is possible to have better drying performance with extra drying option. This option increases water temperature at final rinse step and drying step duration up to 10 min.



Extra Fast

Extra fast option decreases program duration while it is increasing water temperature and pressure to ensure high washing quality in a shorter duration.



Extra Silent

It is possible to have more silent washing with variable speed motor technology! Extra silent option decreases noise level of program without decreasing cleaning quality in day or night time when silence is required.



Extra Hygiene

Extra hygiene option which is developed for Vestel Dishwashers ensures a maximum hygiene with high temperature washing. It increases water temperature at final rinse step in order to eliminate bacteria up to %99.9999.



Super 50'

VESTEL dishwashers achieves A class cleaning performance with advanced cleaning program in only 50 min without diverter. You can save time with this program. It is the first and unique dishwasher that achieves A class cleaning performance in only 50 minutes for STANDARD soiled dishes according to EN standards.



Extra Rinse

Extra rinse option adds an extra rinse step to achieve more hygienic washing. Program duration is increased between min. %4 and max. %16 according to the washing program.



Antibacterial Filter

By using Antibacterial PP Sump Filter bacterial growth on the filter surface eliminated up to 99%.



Delay Timer

The start time of a program can be delayed, e.g. to benefit from economy rates of electricity. A delay start time of between 1 hour and 24 hours can be selected.



Half Load- 1/2 Option

Eco Friendly Ecowash technology provides washing performance when dishwasher is not fully loaded, only lower basket or upper basket or both are used with half load if necessary by using half load option. Ecowash technology saves energy and water by reducing energy and water consumption due to load options.



Variospace

VarioSpace is a general feature that gives many options to the end user regarding lower and upper basket variations.



Bldc Pump Technology

This technology enables all other options and program to save water, energy and time. Also by changing water pressure noise level can be reduced to have more silent washing.



Tablet/All In 1

With this option, water reaches optimum temperature to dissolve the combined detergent ideally and eliminates such drawbacks and assures maximum performance when tablet detergents are used.



Dualpro Wash

Advanced pump technology allows for one wash to be cleaned at two separate water pressures. Baked on food doesn't stand a chance in the bottom while the delicate glasses in the top are gently being washed.



Easy Tray

The upper cutlery basket is designed to place forks, spoons and knives, long dippers and small items. It is possible to take out the dishes along with the 3rd rack after washing. The Upper Cutlery Basket is composed of two pieces; You can take out left or right part of the upper cutlery basket to obtain more space for the dishes in the upper basket

FEATURES



Jet Wash

With this fast program, you can clean the dishes like less and/or recently soiled (coffee, milk and tea etc.) in only 14 minutes. This program is one of the fastest programs in the world. It cleans your dishes with 4 place settings capacity in 14 minutes.



Super Active Drying System

A portion of the washtub wall is a heat exchanger which, at the end of the rinsing cycle, promotes condensation of the water inside the tub, and hence drying of the dishes.



Turbo Drying System

It activates a fan which draws steam out of the dishwasher cabinet. Air circulation is much more forced, hence results in most efficient drying performance.

Heater Safety Protection

In case of lack of water, with the help of a pressure switch, the resistance is prevented from being in operation. So both the resistance and the machine itself are protected.



Child Lock

Child lock option never allows your children to play with your dishwasher. It allows you to lock the buttons on the control panel to be able to restrict the functionality of buttons.



Heater Safety Protection

In case of lack of water, with the help of a pressure switch, the resistance is prevented from being in operation. So both the resistance and the machine itself are protected.



Mini Active Drying System

Mini active drying system provides basic drying performance on dishes with its mini fins.

Overflow And Leakage Protection

The dishwasher activates overflow mode when there is too much water in the dishwasher and the excess water get is drained. It also detects leaks in the base of the dishwasher, shuts down operation and automatically pumps out water before reaching to floor. The unit can auto reset the overflow mode until the water level in the basement cover reaches a certain level.

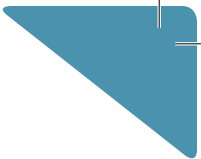

UPPER BASKET



Options

Foldable Wire



Adjustable Mug Shelves



Spoon Rack and Glass Support

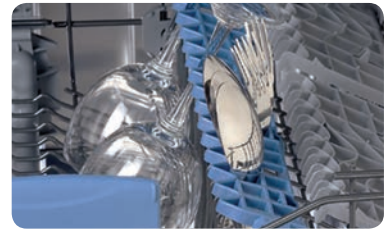

Adjustable Upper Basket with Load



Adjustable Upper Basket without Load



Plastic Handle

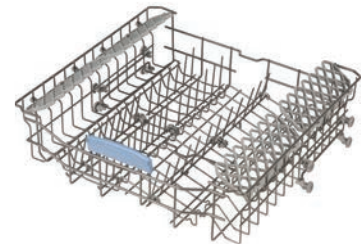

Wire Handle

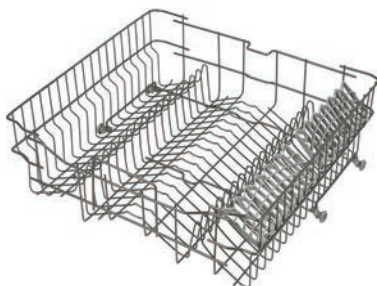

Handle with Customized Logo



* For 15 place settings and only for upper basket

FEATURES

LOWER BASKET

VarioSpace

Options

Foldable Wire
(2 Or 4)



Multi-Functional Kit For
Lower Basket



Bottle Holder



Plastic Handle



Wine Glass Holder

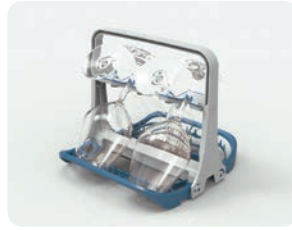

Mug Shelf Support

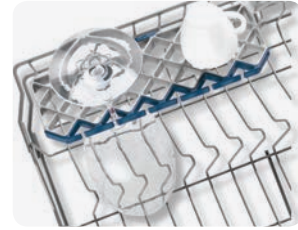

*W/Or W/O Soft Touch

Standard Cutlery Basket



Modular Cutlery Basket
(For 12 Settings)



Universal Cutlery Basket



*Optional For 15 Place Setting

Sliding Cutlery Basket



Sliding Cutlery Basket
(with blue color addition)



Hygiene Box*



*Mandatory after April 2018 according to Performance Standard Update (Edition 4)

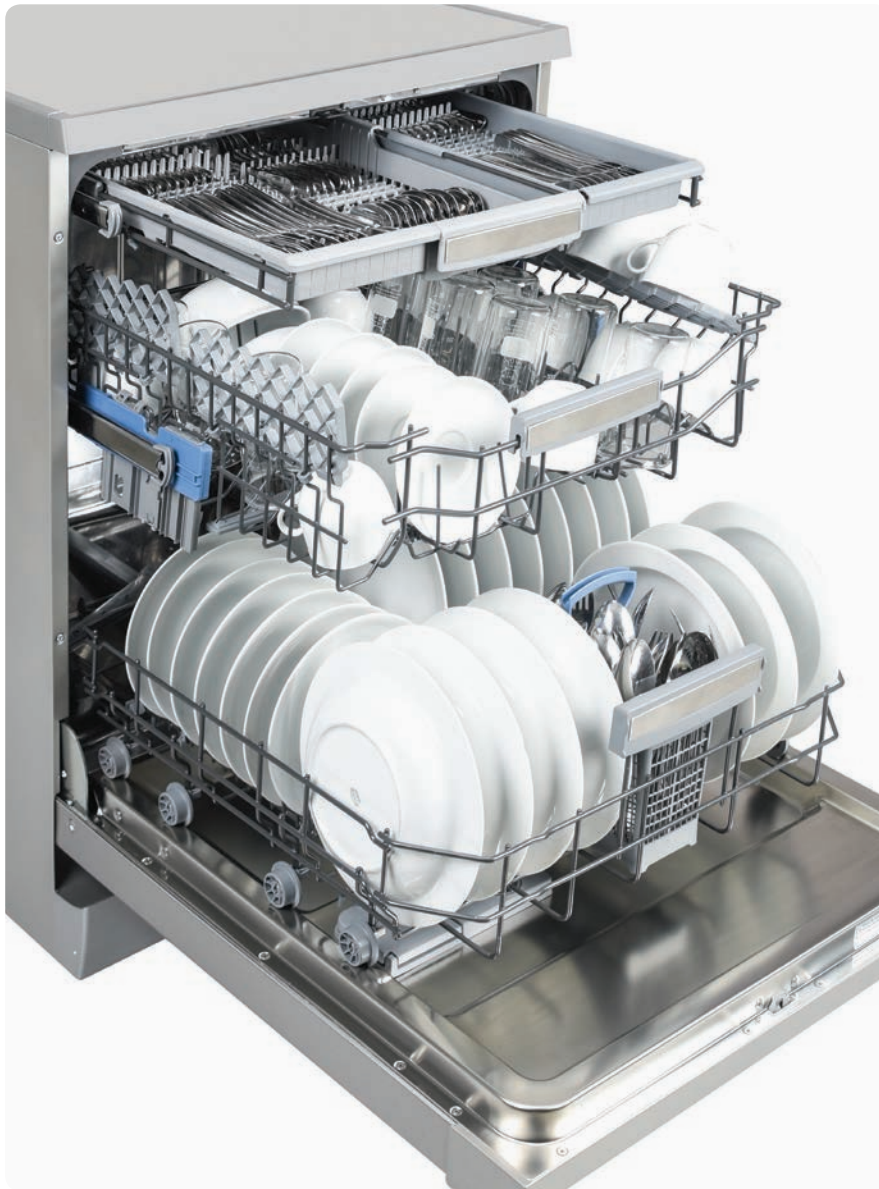

3RD RACK

The upper cutlery basket is designed to place forks, spoons and knives, long dippers and small items. You can take out the dishes along with the 3rd rack after washing. The Upper Cutlery Basket is composed of two pieces; You can take out left or right part of the upper cutlery basket to obtain more space for the dishes in the upper basket.



*15 PS capacity will be updated as 14 PS in April 2018 according to EN-50242:2016 standard.

*Cutlery basket is optional
*Only for 14/15 place settings



NEW 3RD RACK DESIGN



NEW 3RD RACK DESIGN

New design introduction for 3rd rack that provides 14 place setting.

- *Cutlerly basket is optional
- *Optional for 13 place settings
- * Available in December 2017.

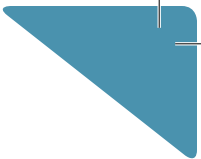

Top Nozzle



Impeller



Aqua Stop



Plastic Filter (Optional)



Stainless Steel Filter (Default)



Anti Bacterial Filter (Optional)



Interior Led Lighting (1 spot-White)



Interior Led Lighting (4 spots-White)*



Interior Led Lighting (4 spots-White)*



* Available for Y2X, C4X, D4X, D5X for the first phase in January 2018.

POP-IN-POP-OUT-KNOB FOR SEMI INTEGRATED DISHWASHER



FEATURES

Adjustable Rear Foot From The Front



Front Decor Fixations Different Weights



Adjustable Plinth



0-100 mm dept adjustment
820-870 mm machine height
adjustment with high feet

The machine can be
elevated by 50 mm
(820 → 870-920 mm
with high feet)

High Feet



Plate Dimension For 12 P.s.



Plate Dimension For 15 P.s.



SEMI-INTEGRATED



FULLY-INTEGRATED



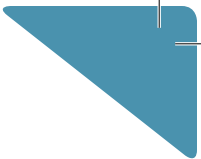

SLIDING DOOR

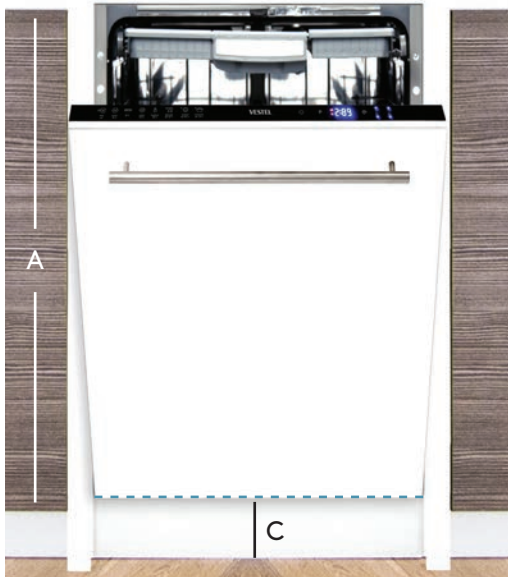

w/o Sliding Door

Max Decorative Panel Height (A)
717 mm

Plinth Depth (B)
30-80 mm

Minimum Plinth Height (C)
80 mm

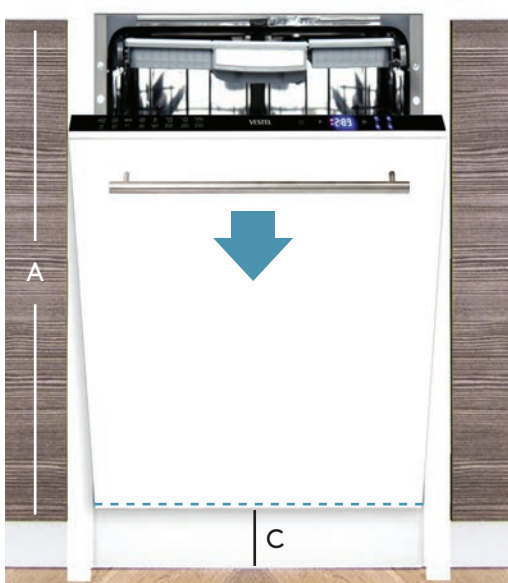

w/Sliding Door (Option 1)

Max Decorative Panel Height (A)
797 mm

Plinth Depth (B)
0-80 mm

Sliding Range
80 mm

Minimum Plinth Height (C)
20 mm

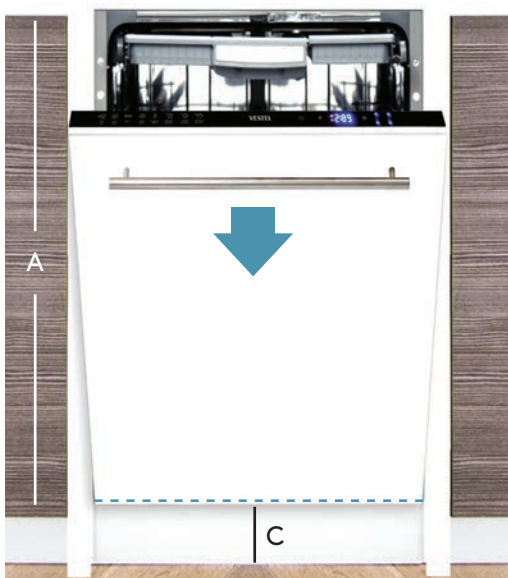

w/Sliding Door (Option 2)

Max Decorative Panel Height (A)
757 mm

Plinth Depth (B)
0-80 mm

Sliding Range
40 mm

Minimum Plinth Height (C)
60 mm



* Introduction in June 2018 for 60 cm range,
in September 2018 for 45 cm range.

SEMI-INTEGRATED: CONTROL PANELS

Patara

T36/
T35/
T34/
T32/
T31



Ares



Amaranth

T26/
T25/
T24/
T21



T12



T13



T11



Camelia - Y

Y21-6



Y11-5
w/o
display



Y1A-F
w/
display



Silva - Y

Y21-6



Y11-5
w/o
display



Y1A-F
w/
display



Camelia

X11-6
w/o
display



X1A-F
w/
display



C41/
C31/
C21

Silva



Rhea

D41



D21



D13



Astrum

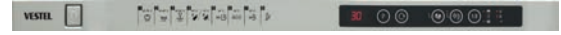

Freya

D53



D52



D51



Freya - Inox Look

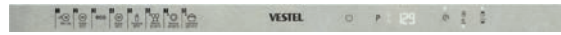
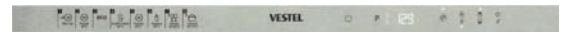

Inox Look Control Panels

60 & 45 cm D5X series (FI)

Versions: D51, D52, D53

Dead front display & full touch control



SEMI-INTEGRATED: CONTROL PANELS

SEMI-INTEGRATED T3X (LED) 60cm Models	T31	T32	T34	T35	T36	SEMI-INTEGRATED T SERIES 60cm Models	T11	T12	T13	T21	T24	T25	T26
Prewash	Yes	Yes	-	-	-	Prewash	-	-	Yes	Yes	-	-	-
Eco	Yes	Yes	Yes	Yes	Yes	Mini 18'	-	-	-	-	Yes	Yes	Yes
Mini 18'	Yes	Yes	Yes	Yes	Yes	Eco	Yes	Yes	Yes	Yes	Yes	Yes	Yes
Quick 30' 40°C	Yes	Yes	Yes	Yes	Yes	Intensive 65°C	Yes	Yes	Yes	-	-	-	-
Super 50' 65°C	Yes	Yes	Yes	Yes	Yes	Quick 30' 40°C	-	Yes	Yes	Yes	Yes	Yes	Yes
Dual Pro Wash 60°C	-	-	Yes	Yes	Yes	Super 50' 65 °C	Yes	Yes	Yes	Yes	Yes	Yes	Yes
Hygiene 70°C	-	-	Yes	Yes	Yes	Delicate 40°C	-	-	Yes	-	-	-	-
Auto Delicate 30°C - 50°C	-	Yes	Yes	Yes	Yes	Daily 60°C	-	-	-	Yes	-	-	-
Auto Normal 50°C - 60°C	-	Yes	-	-	-	Auto Delicate 30°C - 50°C	-	-	-	Yes	Yes	Yes	Yes
Auto Intensive 60°C - 70°C	Yes	Yes	Yes (50°C - 70°C)	Yes (50°C - 70°C)	Yes (50°C - 70°C)	Auto Normal 50°C - 60°C	-	-	-	Yes	-	-	-
						Auto Intensive 60°C - 70°C	-	-	-	Yes	Yes (50°C-70°C)	Yes (50°C-70°C)	Yes (50°C-70°C)
						Hygiene 70°C	-	-	-	-	Yes	Yes	Yes
						Dual Pro Wash 60°C	-	-	-	-	Yes	Yes	Yes

*: Separate function button
 **: X1A-F: with display versions

SEMI-INTEGRATED Y SERIES 60cm Models*	Y11 - Y1A	Y12 - Y1B	Y13 - Y1C	Y14 - Y1D	Y15 - Y1E	Y1F	Y21	Y22	Y23	Y24	Y25	Y26
Prewash	-	-	-	-	Yes	Yes	Yes	Yes	Yes	Yes	Yes	Yes
Mini 18'	-	-	-	-	-	-	-	-	-	-	Yes	Yes
Eco	Yes	Yes	Yes	Yes	Yes	Yes	Yes	Yes	Yes	Yes	Yes	Yes
Intensive 65°C	Yes	Yes	Yes	Yes	Yes	Yes	Yes	Yes	Yes	-	-	-
Quick 30' 40°C	-	-	Yes	Yes	Yes	Yes	Yes	Yes	Yes	Yes	Yes	Yes
Super 50' 65°C	-	Yes	Yes	Yes	Yes	Yes	Yes	Yes	Yes	Yes	Yes	Yes
Dual Pro Wash 60°C	-	-	-	-	-	-	-	-	-	-	Yes	Yes
Delicate 40°C	-	-	-	Yes	Yes	Yes	Yes	Yes	Yes	-	-	-
Daily 60°C	-	-	-	-	-	Yes	-	Yes	Yes	Yes	-	-
Normal 55°C	-	-	-	-	-	-	-	-	Yes	-	-	-
Auto Delicate 30°C - 50°C	-	-	-	-	-	-	-	-	-	Yes	-	-
Auto Normal 50°C - 60°C	-	-	-	-	-	-	-	-	-	Yes	-	-
Auto Intensive 60°C - 70°C	-	-	-	-	-	-	-	-	-	Yes	Yes	Yes
Hygiene 70°C	-	-	-	-	-	-	-	-	-	-	Yes	Yes
Steam Wash	-	-	-	-	-	-	-	-	-	Yes	Yes	Yes

*: Y1A-F: with display versions

SEMI-INTEGRATED X&C SERIES 60cm Models**	X11 - X1A	X12 - X1B	X13 - X1C	X14 - X1D	X15 - X1E	X16 - X1F	C21	C31	C41
Prewash	-	-	-	-	Yes	Yes	Yes*	Yes*	Yes*
Eco 50°C	Yes	Yes	Yes	Yes	Yes	Yes	Yes	Yes	Yes
Intensive 65°C	Yes	Yes	Yes	Yes	Yes	Yes	Yes	Yes	-
Quick 30' 40°C	-	-	Yes	Yes	Yes	Yes	Yes	Yes	Yes
Super 50' 65°C	-	Yes	Yes	Yes	Yes	Yes	Yes	Yes	-
Super 55' 60°C	-	-	-	-	-	-	-	-	Yes
Delicate 40°C	-	-	-	-	-	Yes	-	Yes	-
Auto Delicate 30°C - 50°C	-	-	-	-	-	-	-	-	Yes
Auto Normal 50°C - 60°C	-	-	-	-	-	-	-	-	Yes
Auto Intensive 60°C - 70°C	-	-	-	-	-	-	-	-	Yes
Hygiene 60°C	-	-	-	-	-	-	-	-	Yes
Hygiene 70°C	-	-	-	Yes	Yes	Yes	-	-	-
Extra Intensive 70°C (Prewash Button + Intensive 65°C)	-	-	-	-	-	-	Yes	Yes	-
Extra Hygiene 70°C (Prewash Button + Hygiene 60°C)	-	-	-	-	-	-	-	-	Yes

*: Separate function button **: X1A-F: with display versions

FULLY-INTEGRATED 60cm Models	D13	D21	D41	D51	D52	D53
Prewash	Yes	Yes	Yes	-	-	-
Mini 18'	-	-	-	Yes	Yes	Yes
Eco 50°C	Yes	Yes	Yes	Yes	Yes	Yes
Intensive 65°C	Yes	-	-	Yes	-	-
Intensive 70°C	-	Yes	-	-	-	-
Quick 30' 40°C	-	Yes	Yes	Yes	Yes	Yes
Super 50' 65°C	Yes	Yes	-	Yes	Yes	Yes
Super 55' 60°C	-	-	Yes	-	-	-
Auto Delicate 30°C - 50°C	-	-	Yes	-	Yes	Yes
Auto Normal 50°C - 60°C	-	-	Yes	-	Yes	-
Auto Intensive 60°C - 70°C	-	-	Yes	-	Yes	Yes (50°C-70°C)
Hygiene 60°C	-	-	Yes	Yes	Yes	Yes
Extra Hygiene 70°C (Prewash Button + Hygiene 60°C)	-	-	Yes	-	-	-

*: Y1A-F: with display versions

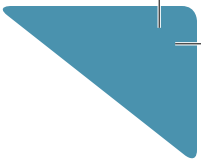

Semi-Integrated Panel Color Options

WHITE

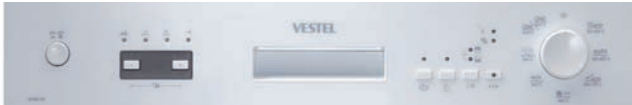

BLACK

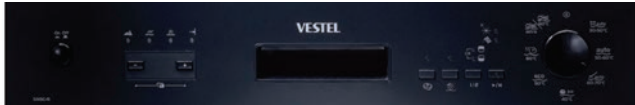

INOX



ALUMINIUM LOOK

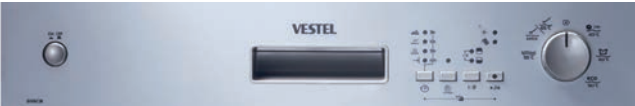

DARK SILVER



WHITE



BLACK



WHITE



BLACK



DARK SILVER



Fully-Integrated Panel Color Options

WHITE



BLACK



DARK SILVER



INOX LOOK



For each aesthetics, please ask for different color options.

T36 Patara



STANDARD FEATURES

- 12/13/15 place settings
- 8 programs, 6+ temperatures
- Rinse aid & salt indicators
- Washing cycle indicators
- Child lock option
- Overflow and leakage protection
- Heater protection
- Half load option (with three modes) (lower basket/upper basket /half load on both baskets)
- Display (remaining time, delay timer)
- Delay timer (1-2-3-...-24hr)
- 3in1 tablet detergent option
- Extra silent option
- Extra fast option
- Extra drying option
- Overflow and leakage protection
- Heater protection
- 9 lt water consumption

PERFORMANCE

- A+++AA, 41 dB(A), 12/13ps
- A+++AA, 39 dB(A), 15ps

COLOR OPTIONS

White / Black / Dark Silver

STANDARD FEATURES

- 14 place settings
- 8 programs, 6+ temperatures
- Rinse aid & salt indicators
- Washing cycle indicators
- Child lock option
- Overflow and leakage protection
- Heater protection
- Half load option (with three modes) (lower basket/upper basket /half load on both baskets)
- Display (remaining time, delay timer)
- Delay timer (1-2-3-...-24hr)
- 3in1 tablet detergent option
- Extra silent option
- Extra fast option
- Energy save option
- Auto door technology
- Water box technology
- Overflow and leakage protection
- Heater protection
- 9 lt water consumption

PERFORMANCE

A+++AA -%20, 44 dB(A)

COLOR OPTIONS

White / Black / Dark Silver

T35 Ares



* Patara is also available

T34 Ares



* Patara is also available

STANDARD FEATURES

12/13/15 place settings
 8 programs, 6+ temperatures
 Rinse aid & salt indicators
 Washing cycle indicators
 Child lock option
 Overflow and leakage protection
 Heater protection
 Half load option (with three modes) (lower basket/upper basket/half load on both baskets)
 Display (remaining time, delay timer)
 Delay timer (1-2-3-...-24hr)
 3in1 tablet detergent option
 Extra silent option
 Extra fast option
 Energy save option
 Auto door technology
 9 lt water consumption

* 13 PS will be also available as an option on May 2017.

PERFORMANCE

A+++AA, 46/44 dB(A), 12/13ps
 A+++AA, 44/42 dB(A), 15ps

COLOR OPTIONS

White/Black/Dark Silver

STANDARD FEATURES

12/13/15 place settings
 8 programs , 6+ temperatures
 Rinse aid & salt indicators
 Washing cycle indicators
 Child lock option
 Overflow and leakage protection
 Heater protection
 Half load option (with three modes) (lower basket/upper basket/half load on both baskets)
 Display (remaining time, delay timer)
 Delay timer (1-2-3-...-24hr)
 3in1 tablet detergent option
 Extra hygiene option
 Extra drying option
 9 lt water consumption

* Ares is also available

PERFORMANCE

A++AA, 54/52/49/47/45 dB(A),
 12/13ps
 A++AA, 49/47/45 dB(A), 15ps

COLOR OPTIONS

White/Black/Dark Silver

T32 Patara



**15 PS capacity will be updated as 14 PS in April 2018 according to EN-50242:2016 standard. 33

T31 Patara



STANDARD FEATURES

12/13/15 place settings
6 programs, 6+ temperatures
Rinse aid & salt indicators
Washing cycle indicators
Child lock option
Overflow and leakage protection
Heater protection
Half load option (with three modes) (lower basket/upper basket /half load on both baskets)
Display (remaining time, delay timer)
Delay timer (1-2-3-...-24hr)
3in1 tablet detergent option
Extra hygiene option
Extra drying option
9 lt water consumption

PERFORMANCE

A++AA, 54/52/49/47/45 dB(A),
12/13ps
A++AA, 49/47/45 dB(A), 15ps

COLOR OPTIONS

White/Black/Dark Silver

* Ares is also available

T26 Amaranth



A+++

STANDARD FEATURES

12/13/15 place settings
 8 programs, 6+ temperatures
 Rinse aid & salt indicators
 Washing cycle indicators
 Child lock option
 Overflow and leakage protection
 Heater protection
 Half load option (with three modes) (lower basket/upper basket /half load on both baskets)
 Display (remaining time, delay timer)
 Delay timer (1-2-3-...-24hr)
 3in1 tablet detergent option
 Extra silent option
 Extra fast option
 Extra drying option
 9 lt water consumption

PERFORMANCE

A+++AA, 41 dB(A), 12/13ps
 A+++AA, 39 dB(A), 15ps

COLOR OPTIONS

White/Black/Dark Silver

STANDARD FEATURES

14 place settings
 8 programs, 6+ temperatures
 Rinse aid & salt indicators
 Washing cycle indicators
 Child lock option
 Overflow and leakage protection
 Heater protection
 Half load option (with three modes) (lower basket/upper basket/half load on both baskets)
 Display (remaining time, delay timer)
 Delay timer (1-2-3-...-24hr)
 3in1 tablet detergent option
 Extra silent option
 Extra fast option
 Energy save option
 Auto door technology
 Water box technology
 9 lt water consumption

PERFORMANCE

A+++AA -%20, 44 dB(A)

COLOR OPTIONS

White/Black/Dark Silver

T25 Amaranth



A+++

T24 Amaranth



STANDARD FEATURES

- 12/13/15 place settings
- 8 programs, 6+ temperatures
- Rinse aid & salt indicators
- Washing cycle indicators
- Child lock option
- Overflow and leakage protection
- Heater protection
- Half load option (with three modes) (lower basket/upper basket /half load on both baskets)
- Display (remaining time, delay timer)
- Delay timer (1-2-3-...-24hr)
- 3in1 tablet detergent option
- Extra silent option
- Extra fast option
- Energy save option
- Auto door technology
- 9 lt water consumption

PERFORMANCE

- A+++AA, 46/44 dB(A), 12/13ps
- A+++AA, 44/42 dB(A), 15ps

COLOR OPTIONS

White/Black/Dark Silver

STANDARD FEATURES

- 12/13/15 place settings
- 8 programs , 6+ temperatures
- Rinse aid & salt indicators
- Washing cycle indicators
- Child lock option
- Overflow and leakage protection
- Heater protection
- Half load option (with three modes) (lower basket/upper basket /half load on both baskets)
- Display (remaining time, delay timer)
- Delay timer (1-2-3-...-24hr)
- 3in1 tablet detergent option
- Extra hygiene option
- Extra drying option
- Extra rinse option
- 9 lt water consumption

PERFORMANCE

- A++AA, 54/52/49/47/45 dB(A), 12/13ps
- A++AA, 49/47/45 dB(A), 15ps

COLOR OPTIONS

White/Black/Dark Silver

T21 Amaranth



T13 Amaranth

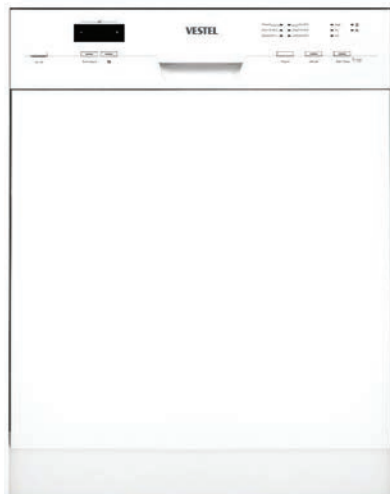

STANDARD FEATURES

12/13 place settings
 6 programs, 3 temperatures
 Rinse aid & salt indicators
 Washing cycle indicators
 Child lock option
 Overflow and leakage protection
 Heater protection
 Half load option (with one mode)
 Display (remaining time, delay timer)
 Delay timer (1-2-3-...-24hr)
 3in1 tablet detergent option
 Extra hygiene option
 12 lt water consumption

PERFORMANCE

A++AA, 57/54/52/49/47/45 dB(A)

COLOR OPTIONS

White / Black / Dark Silver



STANDARD FEATURES

12/13 place settings
 4 programs, 3 temperatures
 Rinse aid & salt indicators
 Washing cycle indicators
 Child lock option
 Overflow and leakage protection
 Heater protection
 Half load option (with one mode)
 Display (remaining time, delay timer)
 Delay timer (1-2-3-...-24hr)
 12 lt water consumption

PERFORMANCE

A++AA, 57/54/52/49/47/45 dB(A)

COLOR OPTIONS

White / Black / Dark Silver

T12 Amaranth



T SERIES

T11 Amaranth

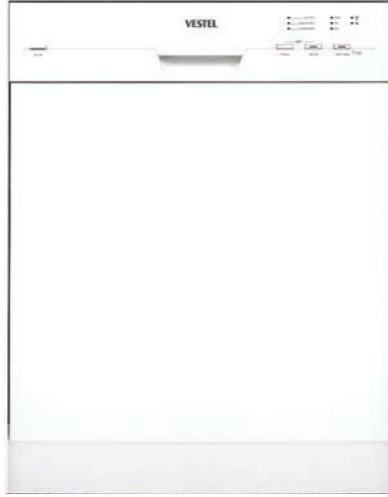

STANDARD FEATURES

12/13 place settings
3 programs, 2 temperatures
Rinse aid & salt indicators
Washing cycle indicators
Child lock option
Overflow and leakage protection
Heater protection
Half Load Option (with one mode)
12 lt water consumption

PERFORMANCE

A++AA, 57/54/52/49/47/45 dB(A)

COLOR OPTIONS

White/Black/Dark Silver

Y26 Silva



A+++

STANDARD FEATURES

12/13/15 place settings
 9 programs, 7+ temperatures
 Rinse aid & salt indicators
 Washing cycle indicators
 Child lock option
 Overflow and leakage protection
 Heater protection
 Half load option (with three modes) (lower basket/upper basket /half load on both baskets)
 Display (delay timer, remaining time)
 Delay timer (1-2-3-...-19hr)
 3in1 tablet detergent option
 Extra silent option
 Extra fast option
 Extra drying
 9 lt water consumption

PERFORMANCE

A+++AA, 41 dB(A), 12/13ps
 A+++AA, 39 dB(A), 15ps

COLOR OPTIONS

A+++AA, 41 dB(A), 12/13ps
 A+++AA, 39 dB(A), 15ps

STANDARD FEATURES

12/13/15 place settings
 9 programs, 7+ temperatures
 Rinse aid & salt indicators
 Washing cycle indicators
 Child lock option
 Overflow and leakage protection
 Heater protection
 Half load option (with three modes) (lower basket/upper basket/half load on both baskets)
 Display (delay timer, remaining time)
 Delay timer (1-2-3-...-19hr)
 3in1 tablet detergent option
 Extra silent option
 Extra fast option
 Energy save option
 Auto door technology
 9 lt water consumption

PERFORMANCE

A+++AA, 46/44 dB(A), 12/13ps
 A+++AA, 44/42 dB(A), 15ps

COLOR OPTIONS

White/Black/Dark Silver

Y25 Camelia



A+++

Y24 Silva



STANDARD FEATURES

- 12/13/15 place settings
- 9 programs, 7+ temperatures
- Rinse aid & salt indicators
- Washing cycle indicators
- Child lock option
- Overflow and leakage protection
- Heater protection
- Half load option (with three modes) (lower basket/upper basket /half load on both baskets)
- Display (delay timer, remaining time)
- Delay timer (1-2-3-...-19hr)
- 3in1 tablet detergent option
- Extra hygiene option
- Extra rinse option
- Extra drying option
- 9 lt water consumption

* Camelia is also available

PERFORMANCE

- A++AA, 54/52/49/47/45 dB(A), 12/13ps
- A++AA, 49/47/45 dB(A), 15ps

COLOR OPTIONS

White/Black/Dark Silver

STANDARD FEATURES

- 12/13/15 place settings
- 8 programs, 5 temperatures
- Rinse aid & salt indicators
- Washing cycle indicators
- Child lock option
- Overflow and leakage protection
- Heater protection
- Half load option (with three modes) (lower basket/upper basket /half load on both baskets)
- Display (delay timer, remaining time)
- Delay timer (1-2-3-...-19hr)
- 3in1 tablet detergent option
- Extra hygiene option
- Extra rinse option
- Extra drying option
- 9 lt water consumption

* Silva is also available

40 **15 PS capacity will be updated as 14 PS in April 2018 according to EN-50242:2016 standard.

PERFORMANCE

- A++AA, 54/52/49/47/45 dB(A), 12/13ps
- A++AA, 49/47/45 dB(A), 15ps

COLOR OPTIONS

White/Black/Dark Silver

Y23 Camelia



Y22 Camelia



STANDARD FEATURES

12/13/15 place settings
 7 programs, 4 temperatures
 Rinse aid & salt indicators
 Washing cycle indicators
 Child lock option
 Overflow and leakage protection
 Heater protection
 Half load option (with three modes) (lower basket/upper basket /half load on both baskets)
 Display (delay timer, remaining time)
 Delay timer (1-2-3-...-19hr)
 3in1 tablet detergent option
 Extra hygiene option
 Extra rinse option
 Extra drying option
 9 lt water consumption

* Silva is also available

PERFORMANCE

A++AA, 54/52/49/47/45 dB(A), 12/13ps

A++AA, 49/47/45 dB(A), 15ps

COLOR OPTIONS

White/Black/Dark Silver

STANDARD FEATURES

12/13/15 place settings
 6 programs, 3 temperatures
 Rinse aid & salt indicators
 Washing cycle indicators
 Child lock option
 Overflow and leakage protection
 Heater protection
 Half load option (with three modes) (lower basket/upper basket/half load on both baskets)
 Display (delay timer, remaining time)
 Delay timer (1-2-3-...-19hr)
 3in1 tablet detergent option
 Extra hygiene option
 Extra rinse option
 Extra drying option
 9 lt water consumption

* Camelia is also available

PERFORMANCE

A++AA, 54/52/49/47/45 dB(A), 12/13ps

A++AA, 49/47/45 dB(A), 15ps

COLOR OPTIONS

A++AA, 54/52/49/47/45 dB(A), 12/13ps

A++AA, 49/47/45 dB(A), 15ps

Y21 Silva



Y11-5 & Y1A-F with display



STANDARD FEATURES

- 12/13 place settings
- 2/3/4/5/6/7 programs, 2/3/4 temperatures
- Rinse aid & salt indicators
- Washing cycle indicators
- Overflow and leakage protection
- Heater protection
- Half load option (with one mode)
- Delay timer (3-6-9hr)
- 12 lt water consumption

* Silva and Camelia aesthetics available

PERFORMANCE

A++AA, 57/54/52/49/47/45 dB(A)

COLOR OPTIONS

White/Black/Dark Silver

EXTRA FEATURES WITH DISPLAY

- Child lock option
- Display (remaining time, Delay timer)
- Delay timer (1-2-3-...-19hr)
- 3in1 tablet detergent option
- Extra hygiene option
- Extra rinse option
- Extra drying option

C41 Silva



STANDARD FEATURES

12/13/15 place settings
 9 programs, 6+ temperatures
 Rinse aid & salt indicators
 Washing cycle indicators
 Child lock option
 Overflow and leakage protection
 Heater protection
 Half load option (with three modes) (lower basket/upper basket /half load on both baskets)
 Display (delay timer, remaining time)
 Delay timer (1-2-3-...-19hr)
 3in1 tablet detergent option
 Prewash button
 9 lt water consumption

* Silva is also available

PERFORMANCE

A++AA, 54/52/49/47/45 dB(A),
 12/13ps
 A++AA, 49/47/45 dB(A), 15ps

PANEL ADD ON MATERIAL

White/Black/Aluminium look
 lexan, inox sheet

STANDARD FEATURES

12/13 place settings
 7 programs, 4 temperatures
 Rinse aid & salt indicators
 Washing cycle indicators
 Child lock option
 Overflow and leakage protection
 Heater protection
 Half load option (with three modes) (lower basket/upper basket/half load on both baskets)
 Delay timer (3-6-9-12hr)
 Prewash button
 9 lt water consumption

* Silva is also available

PERFORMANCE

A++AA, 54/52/49/47/45 dB(A),
 12/13ps
 A++AA, 49/47/45 dB(A),
 (3rd rack)

PANEL ADD ON MATERIAL

White/Black/Aluminium look
 lexan, inox sheet

C31 Silva



C21 Silva



STANDARD FEATURES

- 12 place settings
- 6 programs, 4 temperatures
- Rinse aid & salt indicators
- Washing cycle indicators
- Child lock option
- Overflow and leakage protection
- Heater protection
- Delay timer (3-6-9-12hr)
- Prewash button
- 12 lt water consumption

PERFORMANCE

A++AA, 57/54/52/49/47/45 dB(A)

PANEL ADD ON MATERIAL

White/Black/Aluminium look
lexan, inox sheet



*Camelia is also available

STANDARD FEATURES

- 12/13 place settings
- 2/3/4/5/6/7 programs, 3/4 temperatures
- Rinse aid & salt indicators
- Washing cycle indicators
- Overflow and leakage protection
- Heater protection
- Half load option (with one mode)
- Delay timer (3-6-9hr)
- 12 lt water consumption

PERFORMANCE

A++AA, 57/54/52/49/47/45 dB(A)

PANEL ADD ON MATERIAL

White/Black/Aluminium look
lexan, inox sheet

EXTRA FEATURES WITH DISPLAY

- Child lock option
- Display (remaining time, Delay timer)
- Delay timer (1-19hr)

* Silva and Camelia aesthetics available

* Half-load option and Rinse aid/Salt indicator must be selected together

X11-6 & X1A-F with display



D53 Freya



STANDARD FEATURES

15 place settings
 Hidden control panel
 Touch panel
 8+ programs, 6+ temperatures
 Rinse aid & salt indicators
 Overflow and leakage protection
 Heater protection
 Audible signal (buzzer at the end programme)
 Half load option (with three modes) (lower basket/upper basket /half load on both baskets)
 Display (delay timer, remaining time)
 Delay timer (1-2-3-...-19hr)
 3in1 tablet detergent button
 Energy save option
 Extra silent option
 Extra fast option
 Auto door technology
 InfoLED (optional)
 9 lt water consumption



PERFORMANCE

A++AA, 44 dB(A)

COLOR OPTIONS

Black/Inox look

STANDARD FEATURES

12/13/15 place settings
 Hidden control panel
 Touch panel
 8+ programs, 6+ temperatures
 Rinse aid & salt indicators
 Overflow and leakage protection
 Heater protection
 Audible signal (buzzer) at the end program
 Half load option (with three modes) (lower basket/upper basket /half load on both baskets)
 Display (delay timer, remaining time)
 Delay timer (1-2-3-...-19hr)
 3in1 tablet detergent button
 Extra rinse option
 9 lt water consumption
 InfoLED (optional)

PERFORMANCE

A++AA, 54/52/49/47/45 dB(A),

12/13ps

A++AA, 49/47/45 dB(A), 15ps

COLOR OPTIONS

Black/Inox look

D52 Freya



D51 Freya



STANDARD FEATURES

- 12/13 place settings
- Hidden control panel
- Touch panel
- 6 programs, 3 temperatures
- Rinse aid & salt indicators
- Overflow and leakage protection
- Heater protection
- Audible signal (buzzer) at the end program
- Half load option (with one mode)
- Display (delay timer, remaining time)
- Delay timer (1-2-3-...-19hr)
- 3in1 tablet detergent button
- 12 lt water consumption
- InfoLED (optional)

PERFORMANCE

A++AA, 57/54/52/49/47/45 dB(A)

COLOR OPTIONS

Black/Inox look



STANDARD FEATURES

- 12/13/15 place settings
- Hidden control panel
- Standard or membrane button
- 9+ programs, 6+ temperatures
- Rinse aid & salt indicators
- End of cycle indicator
- Overflow and leakage protection
- Heater protection
- Audible signal (buzzer) at the end of program
- Half load option (with three modes) (lower basket/upper basket /half load on both baskets)
- Display (delay timer, remaining time)
- Delay timer (1-2-3-...-19hr)
- 3in1 tablet detergent button
- Prewash button
- 9 lt water consumption

PERFORMANCE

A++AA, 54/52/49/47/45 dB(A), 12/13ps
A++AA, 49/47/45 dB(A), 15ps

COLOR OPTIONS

White/Black/Dark Silver

D41 Rhea



D21 Rhea



STANDARD FEATURES

- 12/13 place settings
- Hidden control panel
- Standard or membrane button
- 5 programs, 4 temperatures
- Rinse aid & salt indicators
- End of cycle indicator
- Overflow and leakage protection
- Heater protection
- Audible signal (buzzer) at the end of program
- Delay timer (3-6-9hr)
- 12 lt water consumption

PERFORMANCE

A++AA, 57/54/52/49/47/45 dB(A)

COLOR OPTIONS

White/Black/Dark Silver



* Astrum is also available

STANDARD FEATURES

- 12/13 place settings
- Hidden control panel
- Standard or membrane button
- 4 programs, 2 temperatures
- Rinse aid & salt indicators
- End of cycle Indicator
- Overflow and leakage protection
- Heater protection
- Audible signal (buzzer) at the end of program
- 12 lt water consumption

PERFORMANCE

A++AA, 57/54/52/49/47/45 dB(A)

COLOR OPTIONS

White/Black/Dark Silver

D13 Rhea



* Astrum is also available



SEMI-INTEGRATED

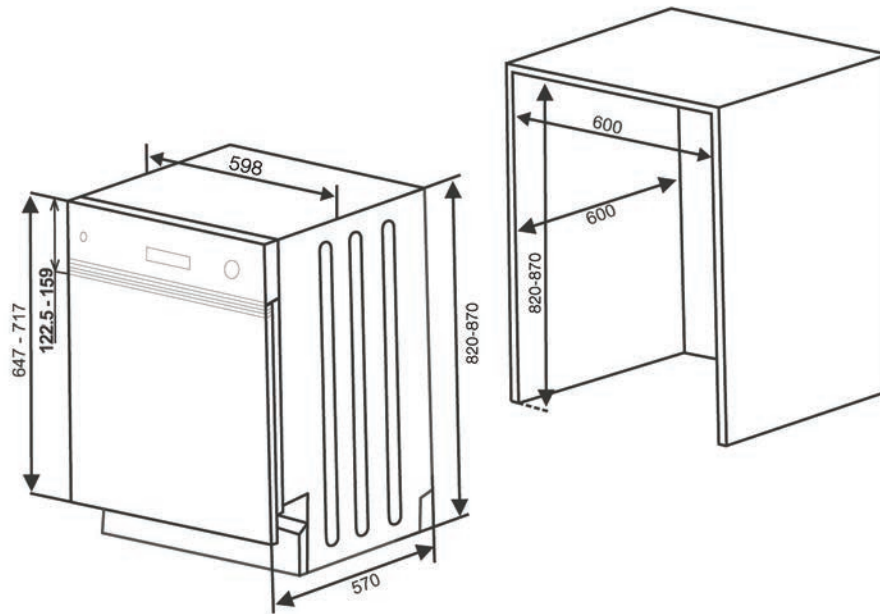

FULLY-INTEGRATED

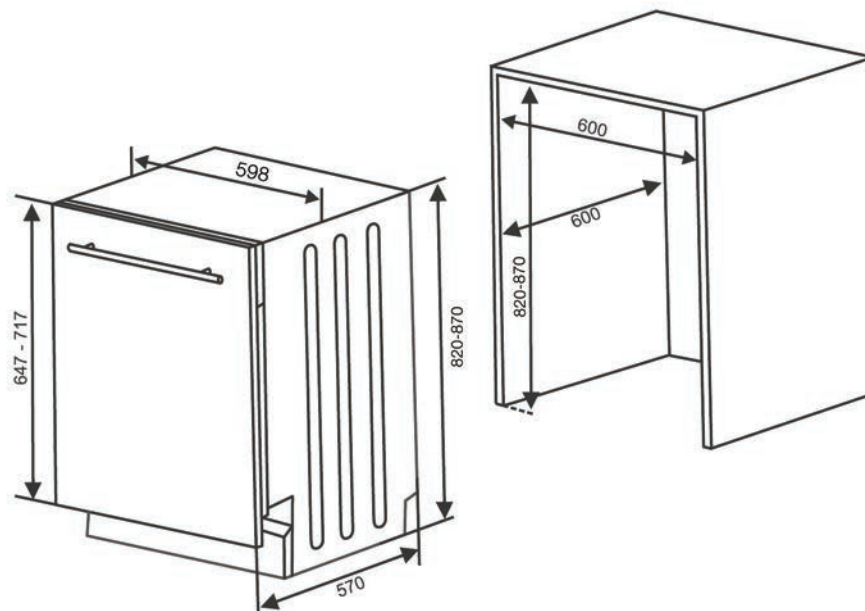

4 5 C M D I S H W A S H E R S



FEATURES

A+++AA/A++AA Class

Top class ratings for "energy consumption", "cleaning & drying performance". The minimum energy class is A++ and the cleaning & drying performance is A for entire model range.

Maximum Plate Diameter

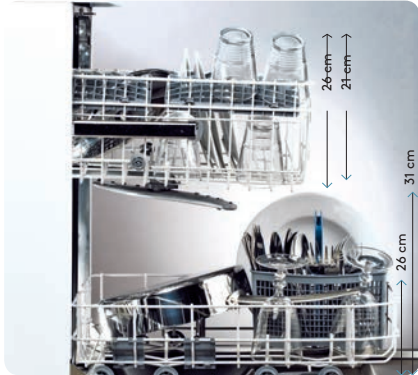

Standard Cutlery Basket



Adjustable Upper Basket



Lower Basket - 10 Place Settings



Adjustable Basket

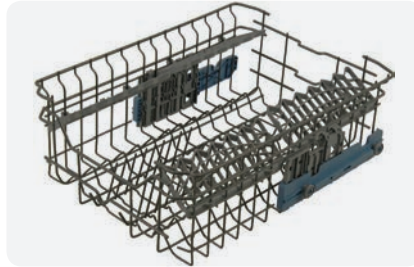

Adjustable only when empty

Adjustable only when loaded

Inox Look Control Panels

60 & 45 cm D5X series (FI)

Versions: D51, D52, D53

Dead front display & full touch control



PROGRAMS

SEMI-INTEGRATED SLIM Y SERIES 45cm Models*	Y11 - Y1A	Y12 - Y1B	Y13 - Y1C	Y14 - Y1D	Y15 - Y1E	Y1F	Y21	Y22	Y23	Y24	Y25
Prewash	-	-	-	-	Yes	Yes	Yes	Yes	Yes	Yes	Yes
Mini 18'	-	-	-	-	-	-	-	-	-	-	Yes
Eco	Yes	Yes	Yes	Yes	Yes	Yes	Yes	Yes	Yes	Yes	Yes
Intensive 65°C	Yes	Yes	Yes	Yes	Yes	Yes	Yes	Yes	Yes	-	-
Quick 30' 40°C	-	-	Yes	Yes	Yes	Yes	Yes	Yes	Yes	Yes	Yes
Super 50' 65°C	-	Yes	Yes	Yes	Yes	Yes	Yes	Yes	Yes	Yes	Yes
Delicate 40°C	-	-	-	Yes	Yes	Yes	Yes	Yes	Yes	-	-
Normal 55°C	-	-	-	-	-	-	-	-	Yes	-	-
Dual Pro Wash 60°C	-	-	-	-	-	-	-	-	-	-	Yes
Daily 60°C	-	-	-	-	-	Yes	-	Yes	Yes	Yes	-
Auto Delicate 30°C - 50°C	-	-	-	-	-	-	-	-	-	Yes	-
Auto Normal 50°C - 60°C	-	-	-	-	-	-	-	-	-	Yes	-
Auto Intensive 60°C - 70°C	-	-	-	-	-	-	-	-	-	Yes	Yes
Hygiene 70°C	-	-	-	-	-	-	-	-	-	-	Yes
Steam Wash	-	-	-	-	-	-	-	-	-	Yes	Yes

SEMI INTEGRATED SLIM X SERIES 45cm Models*	X11 - X1A	X12 - X1B	X13 - X1C	X14 - X1D	X15 - X1E	X16 - X1F
Prewash	-	-	Yes	-	Yes	Yes
Eco	Yes	Yes	Yes	Yes	Yes	Yes
Intensive 65°C	Yes	Yes	Yes	Yes	Yes	Yes
Quick 30' 40°C	-	-	-	Yes	Yes	Yes
Super 50' 65°C	-	Yes	Yes	Yes	Yes	Yes
Delicate 40°C	-	-	-	-	-	Yes
Hygiene 70°C	-	-	-	Yes	Yes	Yes

*: X1C & X1E: with display versions

SEMI INTEGRATED SLIM T SERIES 45cm Models	T14	T15	T21	T22	T24
Prewash	Yes	Yes	Yes	Yes	Yes
Eco	Yes	Yes	Yes	Yes	Yes
Intensive 65°C	Yes	Yes	-	-	-
Quick 30' 40°C	Yes	Yes	Yes	Yes	Yes
Super 50' 65°C	Yes	Yes	Yes	Yes	Yes
Delicate 40°C	Yes	Yes	-	-	-
Dual Pro Wash 60°C	-	-	-	-	Yes
Auto Delicate 30°C - 50°C	-	-	Yes	Yes	Yes
Auto Normal 50°C - 60°C	-	-	Yes	Yes	-
Auto Intensive 60°C - 70°C	-	-	Yes	Yes	Yes (50°C - 70°C)
Hygiene 70°C	Yes	Yes	Yes	Yes	Yes

FULLY-INTEGRATED SLIM D SERIES 45cm Models	D12	D22	D32	D42	D41	D51	D52	D53
Prewash	Yes	Yes	Yes	Yes	Yes	-	-	-
Mini 18'	-	-	-	-	-	Yes	Yes	Yes
Eco 50°C	Yes	Yes	Yes	Yes	Yes	Yes	Yes	Yes
Intensive 65°C	Yes	Yes	Yes	-	-	Yes	-	-
Quick 30' 40°C	-	Yes	Yes	Yes	Yes	Yes	Yes	Yes
Super 50' 65°C	-	Yes	Yes	Yes	Yes	Yes	Yes	Yes
Delicate 40°C	-	-	Yes	-	-	-	-	-
Dual Pro Wash 60°C	-	-	-	-	-	-	-	Yes
Daily 60°C	-	-	Yes	-	-	-	-	-
Auto Delicate 30°C - 50°C	-	-	-	Yes	Yes	-	Yes	Yes
Auto Normal 50°C - 60°C	-	-	-	Yes	Yes	-	Yes	-
Auto Intensive 60°C - 70°C	-	-	-	Yes	Yes	-	Yes	Yes (50°C-70°C)
Hygiene 60°C	-	-	-	-	-	Yes	Yes	Yes
Hygiene 70°C	-	Yes	Yes	Yes	Yes	-	-	-

SEMI AND FULLY-INTEGRATED: CONTROL PANELS

Vento



Camelia - Y*



Lydia - Y*



Klikya - Y*



* Available in December 2017.

** Y11, Y12, Y14 & Y1A, Y1B, Y1D, Y1F & Y21-5 versions will be available in October 2018. Detailed information available in specifications section.

Orchis



*X11, X12, X14, X16, X1A, X1B, X1D, & X1F will be available in October 2018. Detailed information available in specifications section.

Spero

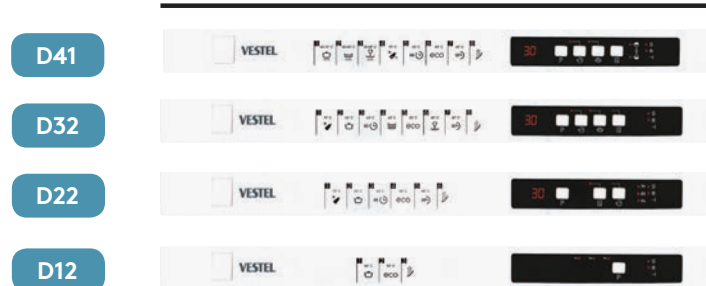

Alinda



Hemen

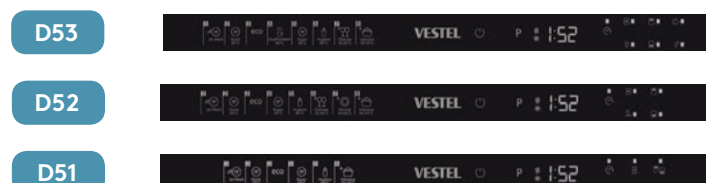

Hemen - Inox Look



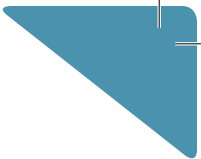

3RD RACK

The upper cutlery basket is designed to place forks, spoons and knives, long dippers and small items. You can take out the dishes along with the 3rd rack after washing. The Upper Cutlery Basket is composed of two pieces; You can take out left or right part of the upper cutlery basket to obtain more space for the dishes in the upper basket.



*Cutlery plastic basket is optional.

T24 Vento

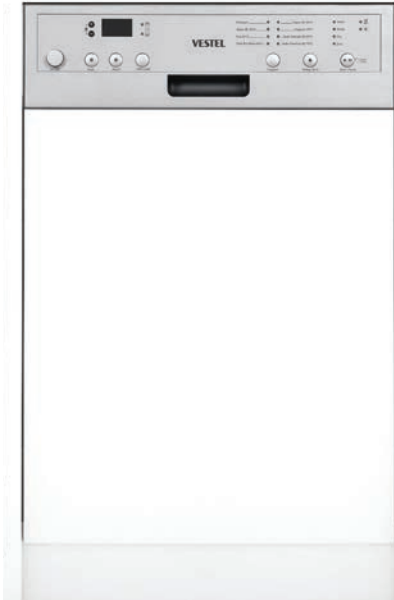

STANDARD FEATURES

- 10 place settings
- 8 programs, 7+ temperatures
- Rinse aid & salt indicators
- Washing cycle indicators
- Child lock option
- Overflow and leakage protection
- Heater protection
- Half load option (with three modes) (lower basket/upper basket /half load on both baskets)
- Display (remaining time, delay timer)
- Delay timer (1-2-3-...-24hr)
- Energy save option
- Extra silent option
- Extra fast option
- Auto door technology
- 9 lt water consumption

PERFORMANCE

A+++AA, 44 dB(A)

COLOR OPTIONS

White, Black, Dark Silver

STANDARD FEATURES

- 10 place settings
- 8 programs, 7+ temperatures
- Rinse aid & salt indicators
- Washing cycle indicators
- Child lock option
- Overflow and leakage protection
- Heater protection
- Half load option (with three modes) (lower basket/upper basket/half load on both baskets)
- Display (remaining time, delay timer)
- Delay timer (1-2-3-...-24hr)
- 3in1 tablet detergent option
- Extra dry option
- Extra rinse option
- 9 lt water consumption

PERFORMANCE

A++AA, 52/49/47/45 dB(A)

COLOR OPTIONS

White, Black, Dark Silver

T22 Vento

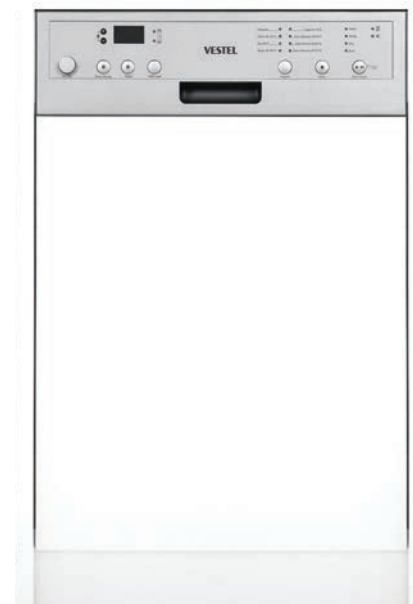

T21 Vento

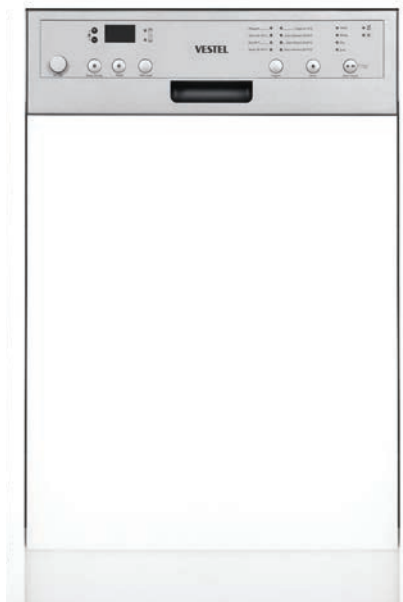

A++

STANDARD FEATURES

- 10 place settings
- 8 programs, 7+ temperatures
- Rinse aid & salt indicators
- Washing cycle indicators
- Child lock option
- Overflow and leakage protection
- Heater protection
- Half load option (with three modes) (lower basket/upper basket /half load on both baskets)
- Display (remaining time, delay timer)
- Delay timer (1-2-3-...-24hr)
- 3in1 tablet detergent option
- Extra dry option
- Extra rinse option
- 9 lt water consumption

PERFORMANCE

A++AA, 54/52/49/47/45 dB(A)

COLOR OPTIONS

White, Black, Dark Silver

STANDARD FEATURES

- 10 place settings
- 7 programs, 4 temperatures
- Rinse aid & salt indicators
- Washing cycle indicators
- Child lock option
- Overflow and leakage protection
- Heater protection
- Delay timer (3-6-9hr)
- 11 lt water consumption

PERFORMANCE

A++AA, 57/54/52/49/47/45 dB(A)

COLOR OPTIONS

White, Black, Dark Silver

T15 Vento

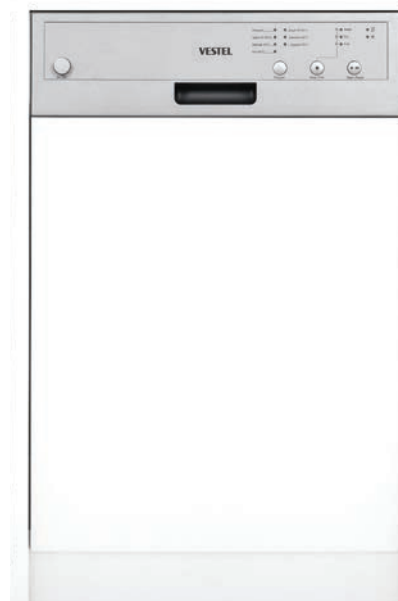

A++

T14 Vento

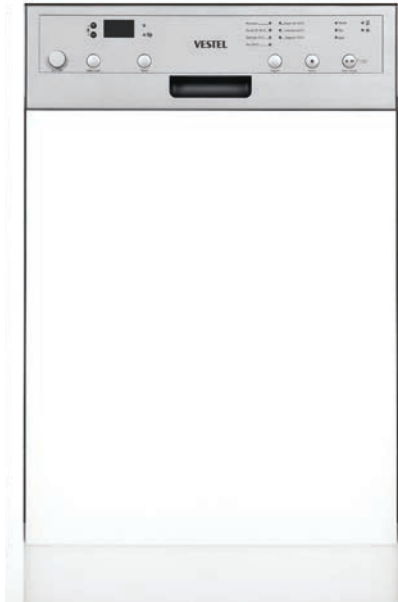

STANDARD FEATURES

- 10 place settings
- 7 programs, 4 temperatures
- Rinse aid & salt indicators
- Washing cycle indicators
- Child lock option
- Overflow and leakage protection
- Heater protection
- Half load option (with one mode)
- Display (remaining time, delay timer)
- Delay timer (1-2-3-...-24hr)
- 3in1 tablet detergent option
- Extra rinse option
- 11 lt water consumption

PERFORMANCE

A++AA, 57/54/52/49/47/45 dB(A)

COLOR OPTIONS

White, Black, Dark Silver



STANDARD FEATURES

- 10 place settings
- 6 programs, 3 temperatures
- Rinse aid & salt indicators
- Washing cycle indicators
- Overflow and leakage protection
- Heater protection
- Half load option (with one mode)
- Delay timer (3-6-9hr)
- 11 lt water consumption

PERFORMANCE

A++AA, 57/54/52/49/47/45 dB(A)

COLOR OPTIONS

White, Black, Dark Silver

EXTRA FEATURES WITH DISPLAY

- Display (remaining time, delay timer)
- Delay timer (1-2-3-...-19hr)
- 3in1 tablet detergent option
- Extra hygiene option
- Extra rinse option
- Extra drying option
- Child lock option

Y15 & Y1E with display



Y13 & Y1C with display

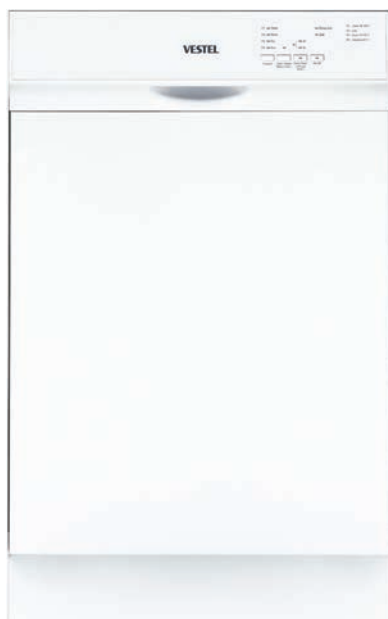

STANDARD FEATURES

- 10 place settings
- 4 programs, 3 temperatures
- Rinse aid & salt indicators
- Washing cycle indicators
- Overflow and leakage protection
- Heater protection
- Half load option (with one mode)
- Delay timer (3-6-9hr)
- 11 lt water consumption

PERFORMANCE

A++AA, 57/54/52/49/47/45 dB(A)

COLOR OPTIONS

White, Black, Dark Silver

EXTRA FEATURES WITH DISPLAY

- Display (remaining time, delay timer)
- Delay timer (1-2-3-...-19hr)
- 3in1 tablet detergent option
- Extra hygiene option
- Extra rinse option
- Extra drying option
- Child lock option



STANDARD FEATURES

- 10 place settings
- 6 programs, 4 temperatures
- Rinse aid & salt indicators
- Washing cycle indicators
- Overflow and leakage protection
- Heater protection
- Half load option (with one mode)
- Delay timer (3-6-9hr)
- 11 lt water consumption

PERFORMANCE

A++AA, 57/54/52/49/47/45 dB(A)

COLOR OPTIONS

White, Black, Dark Silver

EXTRA FEATURES WITH DISPLAY

- Display (remaining time, delay timer)
- Delay timer (1-2-3-...-19hr)
- Child lock option

X15 & X1E with display

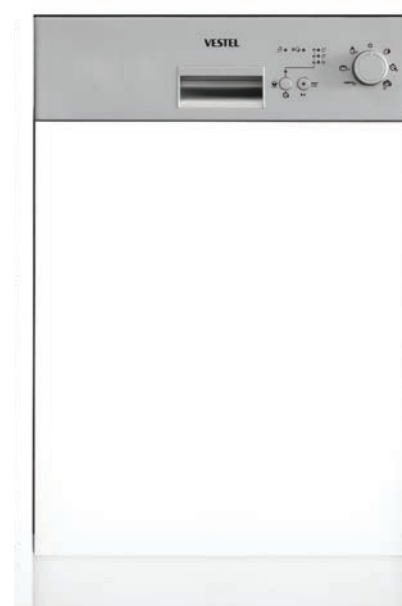

X13 & X1C with display

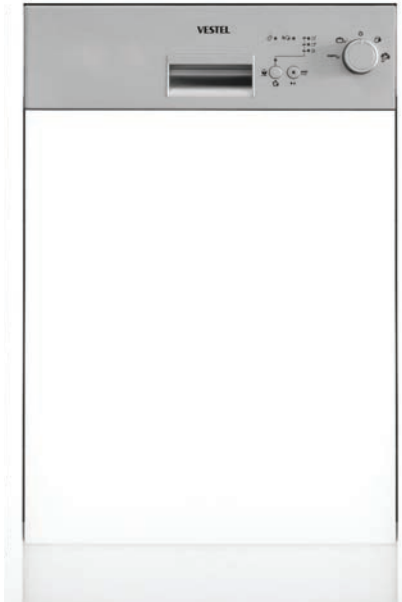

STANDARD FEATURES

- 10 place settings
- 4 programs, 2 temperatures
- Rinse aid & salt indicators
- Washing cycle Indicators
- Overflow and leakage protection
- Heater protection
- Half load option (with one mode)
- Delay timer (3-6-9hr)
- 11 lt water consumption

PERFORMANCE

A++AA, 57/54/52/49/47/45 dB(A)

COLOR OPTIONS

White, Black, Dark Silver

EXTRA FEATURES WITH DISPLAY

- Display (remaining time, delay timer)
- Delay timer (1-2-3-...-19hr)
- Child lock option



STANDARD FEATURES

- 6-8 Programs
- Touch Panel
- Rinse-Aid & Salt Indicators
- Audible Signal (Buzzer At The End Programme)
- Half Load Option (With Three Modes: Lower Basket/Upper Basket/ Half Load On Both Baskets) (D53&D52)
- Half Load Option (With One Mode) (D51)
- Display (Remaining Time, Delay Timer)
- Delay Timer (1-2-3-...-19Hr)
- 3In1 Tablet Detergent Option
- Extra Silent Option (D53)

- Extra Fast Option (D53)
- Energy Save Option(D53)
- Extra Rinse Option(D52), Infoled (Optional)

PERFORMANCE

- D53: A+++AA, 44 dB(A)
- D52: A++AA, 54/52/49/47/45 dB(A)
- D51: A++AA, 57/54/52/49/47/45 dB(A)**

D53-52-51 Hemen

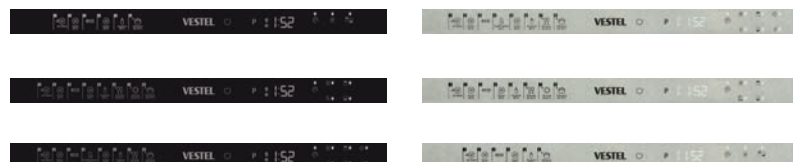

D41 Alinda



STANDARD FEATURES

- 10 place settings
- 8 programs, 7+ temperatures
- Rinse aid & salt indicators
- End of cycle indicator
- Overflow and leakage protection
- Heater protection
- Audible signal (buzzer) at the end program
- Half load option (with three modes) (lower basket/upper basket /half load on both baskets)
- Display (remaining time, delay timer)
- Delay timer (1-2-3-...-19hr)
- 3in1 tablet detergent option
- 9 lt water consumption

PERFORMANCE

A++AA, 52/49/47/45 dB(A)

COLOR OPTIONS

White/Black/Dark Silver

A++



STANDARD FEATURES

- 10 place settings
- 8 programs, 7+ temperatures
- Rinse aid & salt indicators
- End of cycle indicator
- Overflow and leakage protection
- Heater protection
- Audible signal (buzzer) at the end program
- Half load option (with three modes) (lower basket/upper basket /half load on both baskets)
- Display (remaining time, delay timer)
- Delay timer (1-2-3-...-19hr)
- 3in1 tablet detergent option
- 9 lt water consumption

PERFORMANCE

A++AA, 54/52/49/47/45 dB(A)

COLOR OPTIONS

White/Black/Dark Silver

D42 Alinda



A++

D32 Spero



STANDARD FEATURES

- 10 place settings
- 8 programs, 6 temperatures
- Rinse aid & salt indicators
- End of cycle indicator
- Overflow and leakage protection
- Heater protection
- Audible signal (buzzer) at the end program
- Half load option (with one mode)
- Display (remaining time, delay timer)
- Delay timer (1-2-3-...-19hr)
- 3in1 tablet detergent option
- 11 lt water consumption

PERFORMANCE

A++AA, 57/54/52/49/47/45 dB(A)

COLOR OPTIONS

White/Black/Dark Silver



STANDARD FEATURES

- 10 place settings
- 6 programs, 4 temperatures
- Rinse aid & salt indicators
- End of cycle indicator
- Overflow and leakage protection
- Heater protection
- Audible signal (buzzer) at the end program
- Half load option (with one mode)
- Delay timer (3-6-9hr)
- 11 lt water consumption

PERFORMANCE

A++AA, 57/54/52/49/47/45 dB(A)

COLOR OPTIONS

White/Black/Dark Silver

D22 Spero



D12 Spero



STANDARD FEATURES

- 10 place settings
- 3 programs, 2 temperatures
- Rinse aid & salt indicators
- End of cycle indicator
- Overflow and leakage protection
- Heater protection
- Audible signal (buzzer) at the end program
- 11 lt water consumption

PERFORMANCE

A++AA, 57/54/52/49/47/45 dB(A)

COLOR OPTIONS

White/Black/Dark Silver



SEMI-INTEGRATED

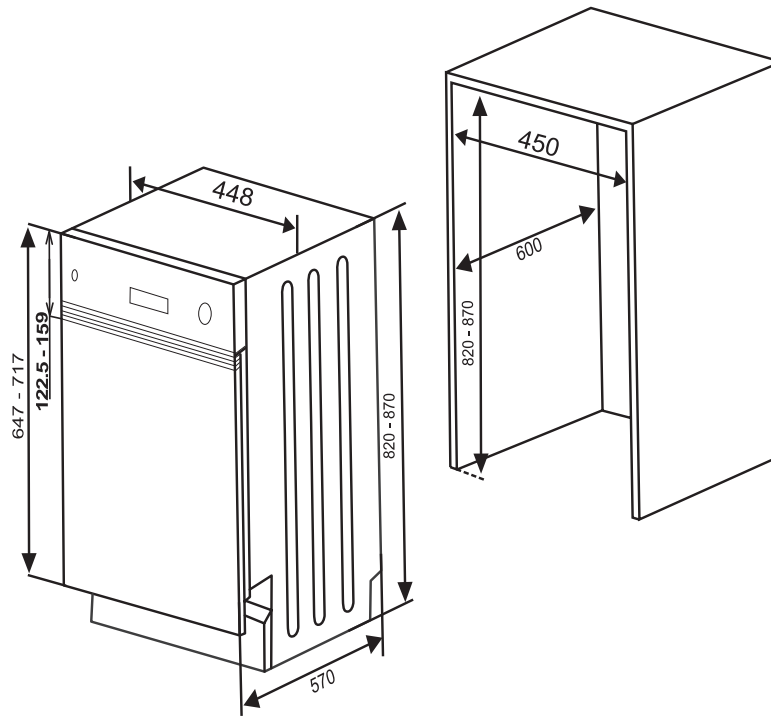

FULLY-INTEGRATED

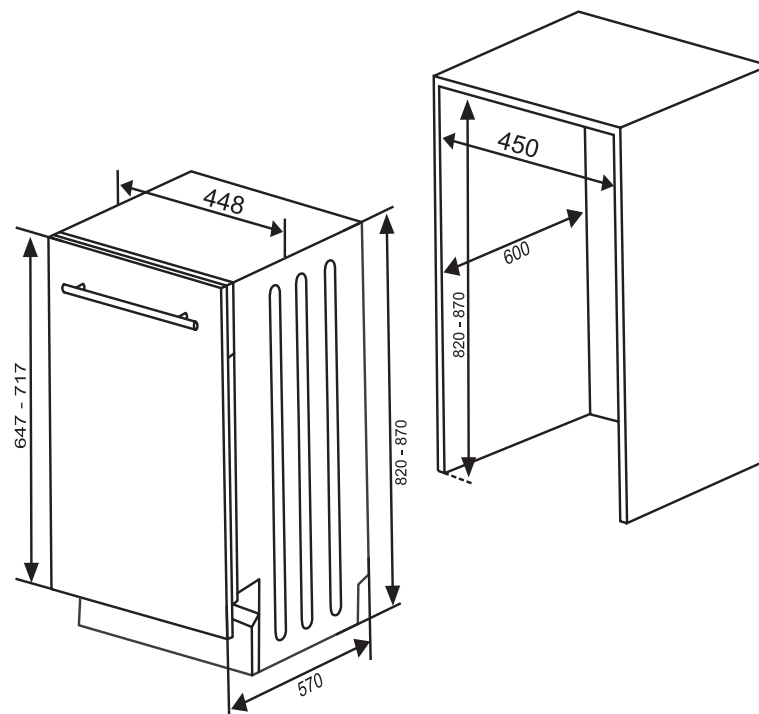

O V E N S



PRODUCT RANGE

BUILT-IN OVENS			
Size	60LT	65LT	75LT
Oven	Electric	Electric	Electric
Hob Control	Yes/No	Yes/No	Yes/No
Cooling System	Yes/No	Yes/No	Yes
Self Clean (Pyro)	No	Yes/No	Yes/No

BUILT-IN HOBS													
Size [cm]	60						70			78		90	
Hob	Gas	Mixed	Gas on Glass	Hotplate	Radiant	Induction	Gas	Mixed	Gas on Glass	Radiant	Induction	Gas	Induction
Control	Side Knob Front Knob	Side Knob Front Knob	Side Knob Front Knob	Side Knob On Built-in Oven	Side Knob Side Touch Front Touch On Built-in Oven	Front Touch On Built-in Oven	Front Knob	Front Knob	Front Knob	Front Touch	Front Touch	Front Knob	Front Touch

DOMINO HOBS					
Size [cm]	30				
Hob	Gas	Gas on Glass	Hotplate	Radiant	Induction
Control	Front Knob	Front Knob	Front Knob	Front Knob Front Touch	Front Touch

FREESTANDING HOBS				
Size [cm]	60			
Hob	Gas	Gas on Glass	Mixed	Hotplate
Control	Side Knob	Front Knob	Side Knob	Side Knob

ready
cook



PRODUCT / ACCESSORY DESCRIPTION

Ready Cook is a new TFT interface with click type knob control for built in ovens.

We're very pleased to bring the color and clarity of TFT displays to a broader range of major home appliances with Vestel's Ready Cook, along with other advanced features previously available only in more high-end oven models.

Ready Cook is designed to help users cook professional recipes easily with auto cooking functions, also allowing the users to implement their own recipes with manual cooking functions. Using a user friendly interface with the colored TFT display creates the charm of Ready Cook compared to the existing models in the high end segment.

FEATURES

- 4.3" TFT LCD Display
- Auto Cooking mode with 150 recipes
- Manuel Cooking mode
- Favorites with 10 recipe slots which can be set by end user
- Vap Clean function
- Multi language support
- Real time clock and date adjustment
- 5 levels of display brightness
- 3 levels of buzzer tone
- Multi language support
- Wi-Fi option
- A+ energy efficiency option
- A++ energy efficiency option

READY COOK RECIPES

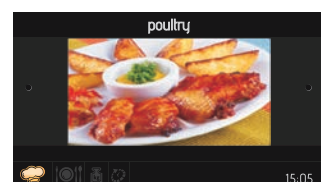
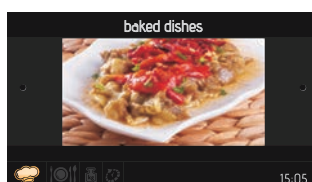
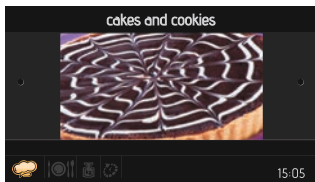
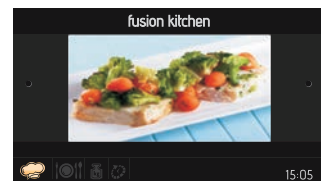
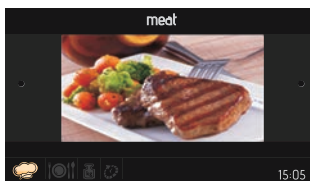
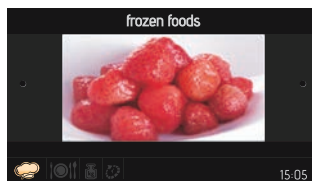
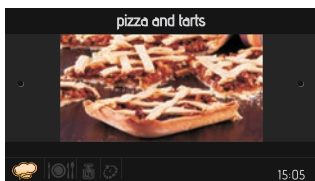
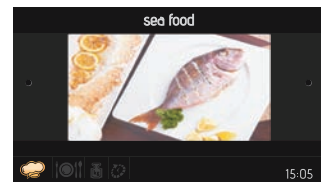
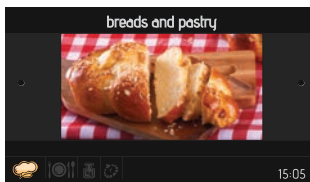
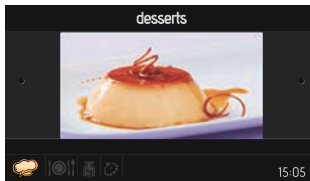
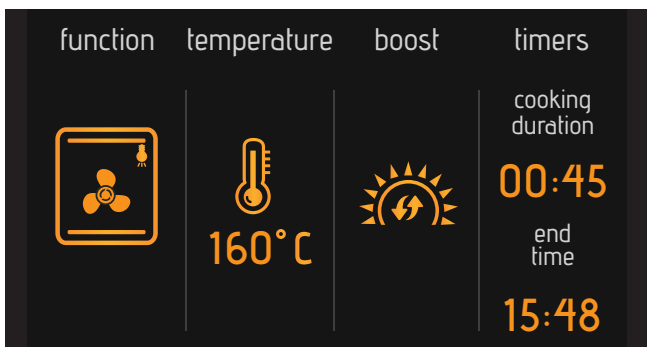
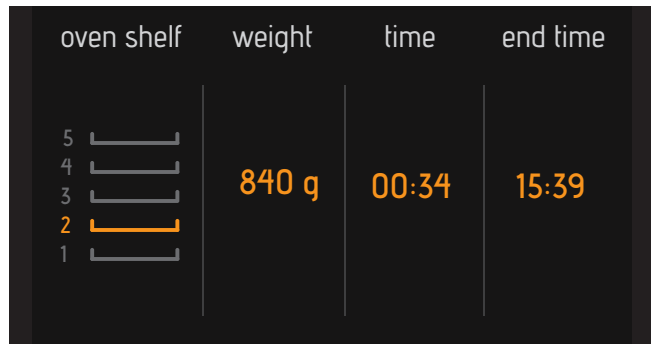
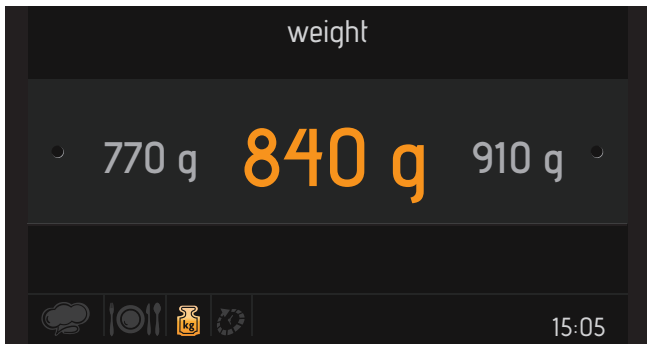



VAPCLEAN® FUNCTION



With VapClean® function, dried food stains inside the oven cavity is softened with vapor.

To perform VapClean® a glass of water is poured into the small tray which will be placed at the bottom of the oven. After that, VapClean® function is activated to create vapor inside oven cavity which will soften dried food stains.



PYROLYSIS FUNCTION



During the pyrolytic cleaning process, the oven heats up to approximately 480°C at which the temperature is kept for 1 hour while the door is locked for safety purposes.

At this temperature, residues from roasting, grilling and baking are reduced to a thin layer of ash that can simply be wiped away with a damp cloth.



A+ ENERGY CLASS FOR ELECTRONIC AND MECHANIC CONTROLLED BUILT-IN OVENS

Energy Efficiency Index(EEI) between 62 to 82 are A+ energy class.

The world's first A+ ovens with mechanic controls.

Available cavity volume: 65lt/75lt

Available control units: All control units

Available with all multifunction ovens (except pyrolytic).



A++ SMART LCD READYCOOK BUILT-IN OVEN

The World's first built-in oven in energy efficiency A++ by the help of TurboLite++ oven function.

TurboLite++ is the name of the cooking function which provides A++ energy class with respect to EU regulation no 65/2014.

TurboLite++ function's declared values are as below.

Energy Consumption (EC): 0.52 kWh/cycle

Energy Efficiency Index(EEI): 61.9 Volume(V): 69lt



LOW NOISE LEVEL BUILT-IN OVEN

During the operation of oven noise level is A-weighted sound power level LwA of 35 dB. A-weighted sound power level LwA of 35 dB is world record and certified by VDE.

Available cavity volume: 65lt/75lt

Available control units: Visio Touch / Full Touch LED
Slim LED Touch



HOTAIRSHIELD: NO MORE HOT AND HUMID AIR OUT

When oven door is opened during cooking, it creates an airstream between control panel and oven bottom panel.

Hence, it prevents the hot and humid air coming out of the oven to reach the end user.

Available cavity volume: 75lt

DOOR TYPES



TYPE 2
LARGE GLASS
OVEN DOOR



TYPE 3
PYROLYTIC
OVEN DOOR



TYPE 4
FULL GLASS
OVEN DOOR



TYPE 5
ACTIVE COOL
OVEN DOOR



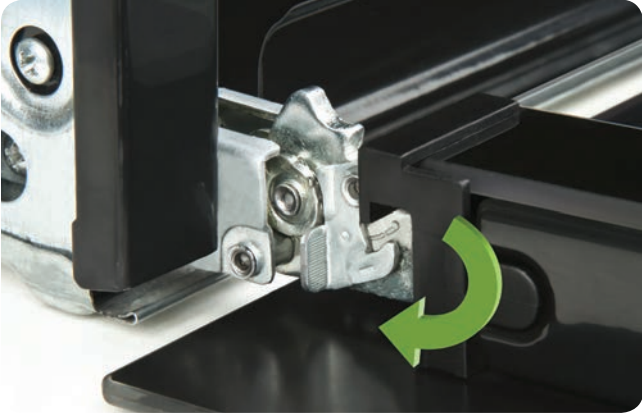

Easy Removable Oven Door
(For Full Inner Glass Over Door)



Easy Removable Oven Door
(For Large Glass and Pyrolytic Oven Doors)



Removable Inner Glass



Door Switch



Soft Close
(For Full Glass And Active Cool Oven Door)



Active Cool Door

DOOR TYPES

I -TYPE ADD
ON 17MM
(LASER CUT)



I -TYPE ADD
ON 50MM
(CLADDING)



I -TYPE ADD
ON 65MM
(CLADDING)



U -TYPE ADD
ON 17MM
(LASER CUT)



U -TYPE ADD
ON 50MM
(CLADDING)



ADD-ON TYPES FOR 60&65 LT BUILT-IN OVENS

U -TYPE ADD
ON 65MM
(CLADDING)



O -TYPE ADD
ON 50MM
(CLADDING)



MONO STRIPE
ADD-ON 15MM
(CLADDING)



MONO
STRIPE ADD
ON 17MM
(LASER CUT)



MONO
STRIPE ADD
ON 50MM
(LASER CUT -
CLADDING)



ADD-ON TYPES FOR 60&65 LT BUILT-IN OVENS

MONO STRIPE
ADD ON 80MM
(LASER CUT)



DUO STRIPE ADD ON
(LASER CUT)

TRIO STRIPE ADD ON
(LASER CUT)



CORNER ADD ON
(LASER CUT)

VISIO TOUCH ADD ON
(LASER CUT)



FULL TOUCH ADD ON
(LASER CUT)

RUSTIC ADD-ON CLADDING

ADD-ON TYPES FOR 75 LT BUILT-IN OVENS

I TYPE ADD
ON 40MM
(CLADDING)



U TYPE ADD
ON 17MM
(LASER CUT)



U TYPE ADD
ON 40MM
(CLADDING)



O TYPE ADD
ON 40MM
(CLADDING)



MONO STRIPE ADD ON 40MM
(LASER CUT)

DUO STRIPE ADD ON 40MM
(LASER CUT)

CONTROL PANEL TYPES



Smart LCD Ready Cook Control Panel



Slim LED Touch Control Panel (for 75lt oven)

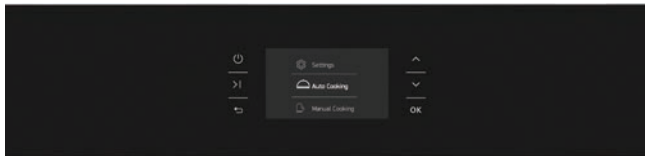

Monochrome LCD Control Panel



Full Touch LED Control Panel

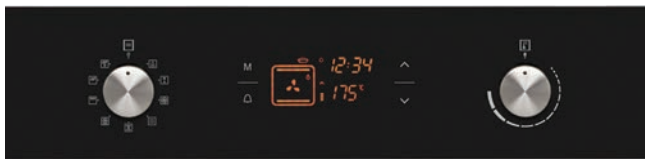

Visio Touch Control Panel



Visio Touch Control Panel



Digital touch timer



Digital Touch Full Programmer



Digital Full Programmer



Digital Full Programmer



Digital Touch Clock And Minute Minder



Digital Touch Clock And Minute Minder

CONTROL PANEL TYPES



Digital Clock And Minute Minder



Digital Clock And Minute Minder



Pyrolytic Digital Programmer



Pyrolytic Digital Programmer



Mechanical Timer



Mechanical Timer



Mechanical Minute Minder



Mechanical Minute Minder



Analog Timer



Analog Timer

CAVITY RACK TYPES



Enamel Mold Runners



Enamel Cavity With Mold Runners



Catalytic Enamel Side Panels



Catalytic Enamel Side And Rear Panels

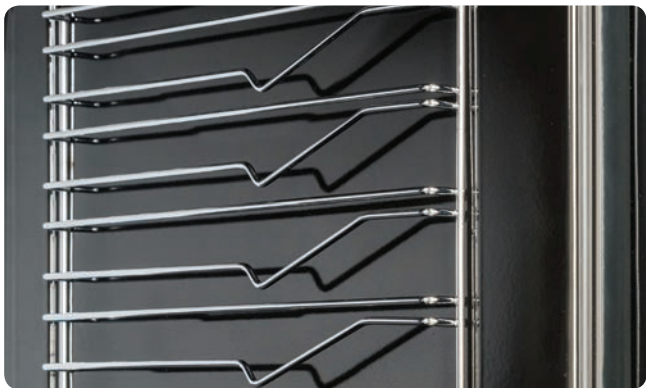

Wire Rack In Enamel Cavity



Wire Racks In Enamel Cavity



Wire Rack In Catalytic Enamel Cavity



Catalytic Enamel Panel With Side Wire Racks

TELESCOPIC SHELF TYPES



Single Telescopic Shelf



Double Telescopic Shelves

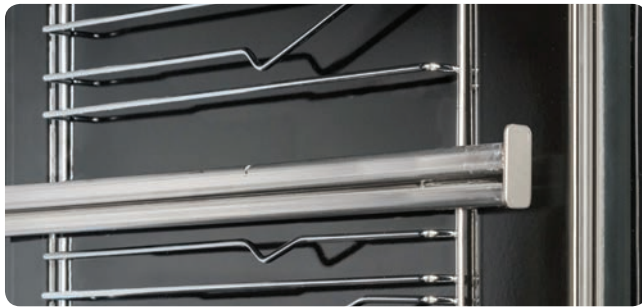

Full Extension Telescopic Shelf



Double Full Extension Telescopic Shelves



Telescopic



Full Extension Telescopic



Telescopic Shelves Stabilizer

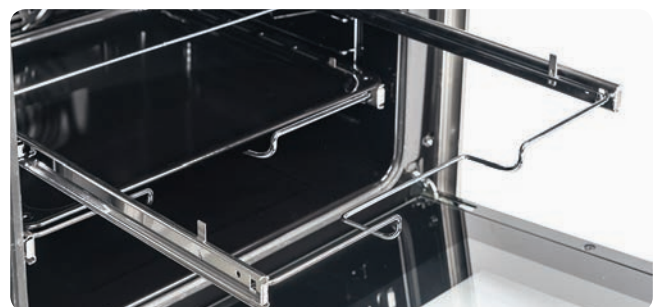

Telescopic Shelves Stabilizer



Wire Rack of 9 Shelves



Wire Rack of 9 Shelves (only 75lt cavity)

OPTIONS



Oven Lamp



Side Lighting



Electric Grill

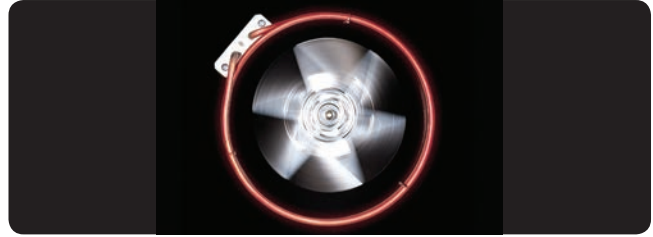

Fan With The Ring For Multifunction Ovens

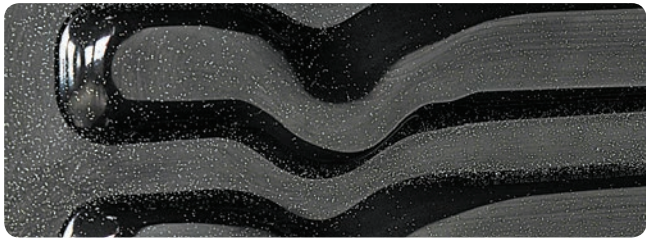

Pyrolytic Enamel



Child Lock



Serigraphy On Knob Ring



Pop in Pop Out Illuminated Knobs

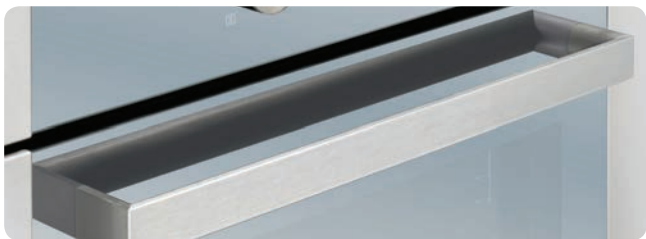

Mirror Glass



Anti Fingerprint Inox Parts



Cooling Fan



Pop In - Pop Out Water Tank



Pure Black Glass Oven Door



Alfa



Antero



Big Antero



Delta Ring



Delta



Eclipse Ring



Eclipse



Gama Ring



Gama



Nord Ring



Nord



Omega



Epsilon



Rimo



Big Rimo



Big Macro



Big Macro Ring



Small Macro



Small Macro with Ring



Pipo

KNOB TYPES



Jannu



Jannu Ring



Spectrum



Vesta



Trio



Big Trio



Vario



Vario Ring



Zeta



Zeta Ring



Rustic Risus



Rustic Risus with Ring



Sigma



Zenith



Feros



3D Quadrangle



Arc Quadrangle



Arc Tube



Bow



Curved Quadrangle

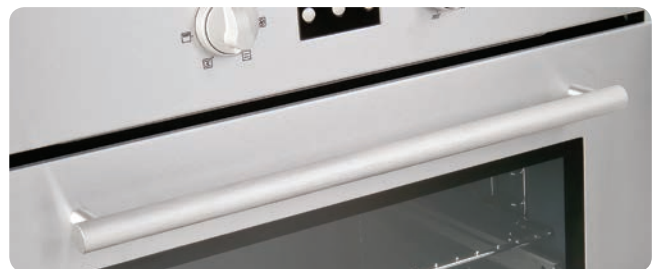

Cylinder



D Profile Arc



Ellipse Arc

HANDLE TYPES



Flat Quadrangle



Flat Slice



Metalux



Risus



Trio



Troy



Vero



Without Cooling Fan Type



Shallow Tray



Deep Tray



80 mm Deep Tray



Chromed Wire Grid For Deep Tray

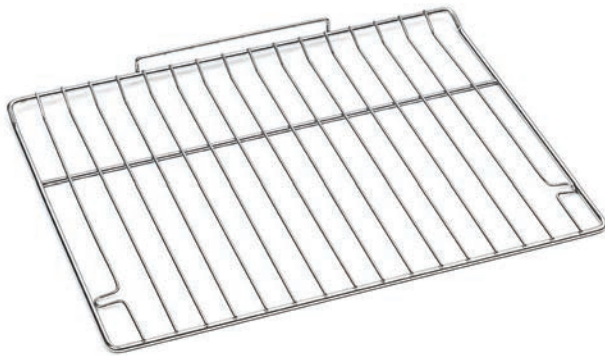

Chromed Wire Grid



Grill Pan Handle Set



Glass Tray



Pizza Set

ACCESSORIES



Grill Pan Handle



Heavy Duty Grill Pan



Oil Filter



Meat Probe



Turnspit Set with Grid



Turnspit Set with Metal Bracket

GENERAL SPECIFICATIONS

60cm BUILT-IN OVEN SPECIFICATION SHEET	60cm ELECTRIC BUILT-IN OVEN	60cm PYROLYTIC BUILT-IN OVEN	60cm ELECTRIC POLYVALENTE BUILT-IN OVEN
Available Colours			
White	Standard	Standard	Standard
Black	Optional	Optional	Optional
Stainless Steel	Optional	Optional	Optional
Terre de France	Optional	Optional	Optional
Mink	Optional	Optional	Optional
Claret Red	Optional	Optional	Optional
Cream	Optional	Optional	Optional
Rustic (White/Black/Cream)	Optional	Optional	Optional
Silver	Optional	Optional	Optional
Control Panel			
Metal	Standard	Standard	Standard
Glass	Optional	Optional	Optional
Various Types of Inox Add-on on Glass Control Panel	Optional	Optional	Optional
Oven Features			
Easy to Clean Enamel	Standard	-	Standard
Catalytic Enamel Panels (Left, right and rear)	Optional	-	Optional
Pyrolytic Enamel		Standard	
Wire Side Racks	Optional	Optional	Optional
Telescopic Rails (1 or 2 racks)	Optional	Optional	Optional
Top Heating Element	Standard	Standard	Standard
Bottom Heating Element	Standard	Standard	Standard
Thermostat	Standard	Electronic	Standard
Grill (Thermostatic)	Optional	Optional	Optional
Double Grill (Thermostatic)	Optional	Optional	Optional
Fan	Optional	Optional	Optional
Fan with Ring Heating Element	Optional	Optional	Optional
Automatic Boost Function	available for some control unit	available for some control unit	available for some control unit
Turnspit	Optional	Optional	Optional
Thermostat Operation Indicator Light	Standard	Standard	Standard
Oven Operation Indicator Light	Standard	-	-
Hotplate Operation Indicator Light (in case of polyvalente oven)	-	-	Standard
Oven Door Switch	Optional	Standard	Optional
Oven Door lock indicator light	-	Standard	-
Minute Minder	Optional	-	Optional
Mechanical Timer	Optional	-	Optional
Analog Timer	Optional	-	Optional
Digital Clock	Optional	-	Optional
Digital Programmer	Optional	Standard	Optional
Digital Programmer with touch interface			
Full Touch LED Display	Optional	Optional	Optional
Knob Control LED Display and Touch Interface (Visio Touch)	Optional	Optional	-
Knob Control LED Display (Visio Display)	Optional	-	-
Smart LCD (Ready Cook)	Optional	-	-
Monochrome LCD	Optional	-	-
Oven Door			
Full outer glass and small inner glass with metal frame (4 glasses)	-	Standard	-
Full inner glass and full glass front face (4 glasses) Oven Door	-	Optional	-
Full outer glass and Inner metal door (small glass) Oven Door	Standard	-	Standard
Full outer glass and full inner glass Oven Door	Optional	-	Optional
Full inner glass and full glass front face Oven Door	Optional	-	Optional
Cool touch Oven door	Optional	-	Optional
Flotal Oven Door Glass	Optional	-	Optional
Removable Oven Door	Standard	Standard	Standard
Various Types of Inox Add-on on Oven Door Glass	Optional	Optional	Optional
Child Lock on Oven Door	Optional	Standard (Electromechanic)	Optional
Accessories			
Oven Light (25W)	Optional	Standard	Optional
Oil Filter	Optional	Optional	Optional
Meat Probe	Optional	-	Optional
Baking Tray (Shallow Tray)	Optional	1	Optional
Roasting Tray (Deep Tray)	1	Optional	1
Glass Tray	Optional	Optional	Optional
Chromed Grid with Stoper	1	1	1
Wire grid for deep tray	Optional	Optional	Optional
Broil Pan with Handle Set	Optional	Optional	Optional
Multi Purpose Rorisserie	Optional	Optional	Optional
Turnspit	Optional	Optional	Optional
Packaging			
Shrink Packaging	Optional	Optional	-
Carton Box Packaging	Optional	Optional	Standard

SINGLE OVENS



BO.110

FEATURES

- 60 cm single built-in electric oven
- 75 lt inner cavity
- Steam-assisted cooking
- Smart LCD Ready Cook control panel
- Inox knob
- Inox handle
- Horizontal slim and bold laser cut inox add-on



BO.94

FEATURES

- 60 cm single built-in electric oven
- 75 lt inner cavity
- Smart LCD Ready Cook control panel
- Inox knob
- Inox handle
- U type slim laser cut inox add-on control panel
- U type slim laser cut inox add-on oven door



BO.112

FEATURES

- 60 cm single built-in electric oven
- 75 lt inner cavity
- Smart LCD Ready Cook control panel
- Inox knob
- Inox handle
- Pure black glass oven door
- Air curtain



BO.113

FEATURES

- 60 cm single built-in electric oven
- 75 lt inner cavity
- Slim LED Touch control panel
- Inox knob
- U type slim laser cut inox add-on control panel
- U type slim laser cut inox add-on oven door



BO.114

FEATURES

- 60 cm single built-in electric oven
- 75 lt inner cavity
- Monochrome control panel
- Black glass control panel and over door
- Dark inox cladding add-on control panel
- Dark inox cladding add-on oven door
- Dark inox handle



BO.105

FEATURES

- 60 cm single built-in electric oven
- 75 lt inner cavity
- Monochrome control panel
- Black glass control panel and over door
- Black painted handle

SINGLE OVENS



BO.109

FEATURES

- 60 cm single built-in electric oven
- 75 lt inner cavity
- Full Touch LED control panel
- White colored display
- Inox handle
- Side vertical inox cladding add-on control panel
- Side vertical inox cladding add-on oven door



BO.106

FEATURES

- 60 cm single built-in electric oven
- 75 lt inner cavity
- Visio Touch control panel
- Slim inox control panel
- Amber colored display
- Inox pop-in pop-out knobs
- Inox handle
- Horizontal bold laser cut inox add-on oven door



BO.96

FEATURES

- 60 cm single built-in electric oven
- 75 lt inner cavity
- Visio Touch control panel
- Amber colored display
- Inox pop-in pop-out knobs
- Inox handle
- White optical glass slim control panel
- White optical glass oven door



BO.98

FEATURES

- 60 cm single built-in electric oven
- 75 lt inner cavity
- Digital full programmer
- Inox slim control panel
- Inox knob
- Inox handle
- Side vertical inox cladding add-on oven door



BO.97

FEATURES

- 60 cm single built-in electric oven
- 75 lt inner cavity
- Digital touch timer
- White knobs
- White handle
- White optical glass slim control panel
- White optical glass oven door



BO.99

FEATURES

- 60 cm single built-in electric oven
- 75 lt inner cavity
- Mechanical timer
- Inox pop-in pop-out knobs
- Inox handle
- O type inox cladding add-on control panel
- O type inox cladding add-on oven door

SINGLE OVENS



BO.115 Pyro

FEATURES

- 60 cm single built-in electric oven
- 75 lt inner cavity
- Pyrolytic Function
- Pyrolytic digital timer
- Inox control panel
- Inox handle
- Inox painted knobs
- U type inox cladding add-on oven door



BO.67 Pyro

FEATURES

- 60 cm single built-in electric oven
- 65 lt inner cavity
- Pyrolytic Function
- Full Touch LED control panel
- Amber colored display
- Inox handle
- Horizontal laser cut inox add-on control panel
- Horizontal laser cut inox add-on oven door



BO.85 Pyro

FEATURES

- 60 cm single built-in electric oven
- 65 lt inner cavity
- Pyrolytic Function
- Visio Touch control panel
- Amber colored display
- Inox pop-in pop-out knobs
- Inox handle
- Side vertical inox cladding add-on oven door



BO.86 Ready Cook

FEATURES

- 60 cm single built-in electric oven
- Smart LCD Ready Cook control panel
- Metal clad knobs
- Inox handle
- U type cladding inox add-on control panel
- U type cladding inox add-on oven door
- Anti-fingerprint inox material



BO.87 Ready Cook

FEATURES

- 60 cm single built-in electric oven
- Smart LCD Ready Cook control panel
- Metal clad knobs
- Inox handle
- Mirror glass control panel and over door
- Side vertical cladding inox add-on control panel
- Side vertical cladding inox add-on oven door



BO.88 Ready Cook

FEATURES

- 60 cm single built-in electric oven
- Steam-assisted cooking
- Smart LCD Ready Cook control panel
- Metal clad knobs
- Inox handle
- Black glass control panel and over door

SINGLE OVENS



BO.66 Full Touch

FEATURES

- 60 cm single built-in electric oven
- Full Touch LED control panel
- Amber colored display
- Inox handle
- Horizontal laser cut inox add-on control panel
- Horizontal laser cut inox add-on oven door



BO.70 Full Touch

FEATURES

- 60 cm single built-in electric oven
- Full Touch LED control panel
- Amber colored display
- Inox handle
- Side vertical cladding inox add-on control panel
- Side vertical cladding inox add-on oven door



BO.75 Full Touch

FEATURES

- 60 cm single built-in electric oven
- Full Touch LED control panel
- Amber colored display
- Inox handle
- Horizontal laser cut inox add-on oven door
- Laser cut inox add-on control panel



BO.77 Visio Touch

FEATURES

- 60 cm single built-in electric oven
- Visio Touch control panel
- Amber colored display
- Amber colored illuminated Inox pop-in pop-out knobs
- Inox handle
- Horizontal laser cut inox add-on control panel
- Horizontal laser cut inox add-on oven door



BO.78 Visio Touch

FEATURES

- 60 cm single built-in electric oven
- Visio Touch control panel
- Amber colored display
- Inox pop-in pop-out knobs
- Inox handle
- White optical glass control panel and oven door
- U type cladding inox add-on control panel
- U type cladding inox add-on oven door



BO.83 Visio Touch

FEATURES

- 60 cm single built-in electric oven
- Visio Touch control panel
- Amber colored display
- Inox control panel
- Inox pop-in pop-out knobs
- Inox handle
- Horizontal laser cut inox add-on oven door

SINGLE OVENS



BO.65 Pyro

FEATURES

- 60 cm single built-in electric oven
- Pyrolytic Function
- Pyrolytic digital timer
- Inox painted knobs
- Inox handle
- Side vertical inox cladding add-on oven door
- U type cladding inox add-on control panel



BO.89 Pyro

FEATURES

- 60 cm single built-in electric oven
- Pyrolytic Function
- Pyrolytic digital timer
- Inox pop-in pop-out knobs
- Inox handle
- Horizontal laser cut inox add-on oven door



BO.90 Pyro

FEATURES

- 60 cm single built-in electric oven
- Pyrolytic Function
- Pyrolytic digital timer
- White painted glass control panel
- White painted glass oven door
- White painted knobs and handle



BO.116 Monochrome

FEATURES

- 60 cm single built-in electric oven
- Monochrome control panel
- Black glass control panel and oven door
- Inox handle
- U type slim laser cut inox add-on control panel
- U type slim laser cut inox add-on oven door



BO.100

FEATURES

- 60 cm single built-in electric oven
- Digital touch timer
- Metal clad knobs
- Inox handle
- Side vertical laser-cut inox add-on control panel
- Side vertical laser-cut inox add-on oven door



BO.117

FEATURES

- 60 cm single built-in electric oven
- Digital touch timer
- Inox control panel
- Black glass oven door
- Inox handle
- Metal clad knobs
- U type inox cladding add-on oven door

SINGLE OVENS



BO.74

FEATURES

- 60 cm single built-in electric oven
- Digital full programmer
- Amber colored illuminated pop-in pop-out knobs
- Inox handle
- U type slim laser cut inox add-on control panel
- U type slim laser cut inox add-on oven door



BO.05

FEATURES

- 60 cm single built-in electric oven
- Digital full programmer
- Inox painted knobs
- Inox handle
- Black glass control panel and oven door
- U type cladding inox add-on control panel
- U type cladding inox add-on oven door



BO.82

FEATURES

- 60 cm single built-in electric oven
- Digital full programmer
- Inox pop-in pop-out knobs
- Inox handle
- Corner type laser cut inox add-on control panel
- Horizontal laser cut inox add-on oven door



BO.73

FEATURES

- 60 cm single built-in electric oven
- Digital full programmer
- Black painted knobs
- Black painted handle
- Special black hairline cladding add-on control panel
- Special black hairline cladding add-on oven door



BO.42

FEATURES

- 60 cm single built-in electric oven
- Digital full programmer
- Inox pop-in pop-out knobs
- Inox handle
- Mink colored optical glass control panel and oven door



BO.13

FEATURES

- 60 cm single built-in electric oven
- Digital full programmer
- Inox pop-in pop-out knobs
- Inox handle
- White optical glass control panel
- White optical glass oven door
- Side vertical cladding inox add-on control panel
- Side vertical cladding inox add-on oven door

SINGLE OVENS



BO.37

FEATURES

- 60 cm single built-in electric oven
- Digital clock and minute minder
- Black knobs
- Black handle
- Black painted metal control panel
- Black glass oven door



BO.24

FEATURES

- 60 cm single built-in electric oven
- Digital clock and minute minder
- Metal clad knobs
- Inox handle
- Black glass control panel
- Black glass oven door



BO.26

FEATURES

- 60 cm single built-in electric oven
- Digital clock and minute minder
- White painted knobs
- White painted handle
- White painted metal control panel
- White painted glass oven door



BO.36

FEATURES

- 60 cm single built-in electric oven without cooling fan
- Digital clock and minute minder
- Inox painted knobs
- Inox handle (without cooling fan type)
- Inox control panel
- Black glass oven door



BO.39

FEATURES

- 60 cm single built-in electric oven
- Mechanical timer
- Inox knob
- Inox handle
- Mirror glass oven door



BO.17

FEATURES

- 60 cm single built-in electric oven
- Mechanical timer
- Inox painted knobs
- Inox handle
- Inox control panel
- Horizontal laser cut inox add-on oven door

SINGLE OVENS



BO.09

FEATURES

- 60 cm single built-in electric oven
- Mechanical timer
- White painted knobs
- White painted handle
- Black painted glass control panel and oven door
- Side vertical white serigraphy on control panel
- Side vertical white serigraphy on oven door



BO.25

FEATURES

- 60 cm single built-in electric oven
- Mechanical timer
- Black painted knobs
- Black painted handle
- TDF optical glass control panel
- TDF optical glass oven door



BO.29

FEATURES

- 60 cm single built-in electric oven
- Mechanical timer
- White knobs
- White handle
- White painted metal control panel
- White painted glass oven door



BO.118

FEATURES

- 60 cm single built-in electric oven
- Metal clad knobs
- Inox handle
- Black glass control panel
- Black glass oven door



BO.18

FEATURES

- 60 cm single built-in electric oven
- Inox painted knobs
- Inox handle
- Inox control panel
- Black glass oven door



BO.30

FEATURES

- 60 cm single built-in electric oven
- White painted knobs
- White painted handle
- White painted metal control panel
- White glass oven door

SINGLE OVENS



BO.107

FEATURES

- 60 cm single built-in electric oven
- Analog timer
- Rustic style Risus knobs
- Rustic style Risus handle
- Black rustic style cladding add-on control panel
- Black rustic style cladding add-on oven door



BO.108

FEATURES

- 60 cm single built-in electric oven
- Analog timer
- Rustic style Risus knobs
- Rustic style Risus handle
- Sand colored rustic style cladding add-on control panel
- Sand colored rustic style cladding add-on oven door



BO.119

FEATURES

- 60 cm single built-in electric oven
- Mechanical timer
- Rustic style Risus knobs
- Rustic style Risus handle
- White colored rustic style cladding add-on control panel
- White colored rustic style cladding add-on oven door



BO.50

FEATURES

- 60 cm single built-in electric oven
- Mechanical timer
- Rustic style Risus knobs
- Rustic style Risus handle
- Type-C rustic design artwork
- Sand colored rustic style cladding add-on oven door



BO.48

FEATURES

- 60 cm single built-in electric oven
- Analog timer
- Rustic style Risus knobs
- Rustic style Risus handle
- Type-A rustic design artwork
- Black glass control panel and oven door



BO.46

FEATURES

- 60 cm single built-in electric oven
- Rustic style Risus knobs
- Rustic style Risus handle
- Type-B rustic design artwork
- White optical glass control panel
- White optical glass oven door

COMBI OVENS



BO.101

FEATURES

- 60 cm combi electric oven
- Digital touch timer
- 75 lt inner cavity
- Inox pop-in pop-out knobs
- Inox handle
- Black glass slim control panel



BO.111

FEATURES

- 60 cm combi electric oven
- Digital touch timer
- 75 lt inner cavity
- Metal cladded knobs
- Inox handle
- Inox slim control panel
- O type inox cladding add-on oven door



BO.102

FEATURES

- 60 cm combi electric oven
- Digital full programmer
- 75 lt inner cavity
- Inox pop-in pop-out knobs
- Inox handle
- Inox slim control panel



BO.103

FEATURES

- 60 cm combi electric oven
- Mechanical timer
- 75 lt inner cavity
- Inox pop-in pop-out knobs
- Inox handle
- Inox slim control panel
- U type inox cladding add-on oven door



BO.91

FEATURES

- 60 cm combi electric oven
- Visio Touch control panel
- White colored display
- Black glass control panel
- Inox pop-in pop-out knobs
- Inox handle
- Horizontal laser-cut inox cladding on oven door



BO.01

FEATURES

- 60 cm combi electric oven
- Inox pop-in pop-out knobs
- Inox handle
- Black glass control panel and oven door
- O type inox cladding add-on control panel
- U type inox cladding add-on oven door
- Digital full programmer

COMBI OVENS



BO.104

FEATURES

- 60 cm combi electric oven
- Digital touch timer
- Inox painted knobs
- Inox handle
- Black glass control panel and oven door
- Horizontal laser cut inox add-on control panel
- Horizontal laser cut inox add-on oven door



BO.02

FEATURES

- 60 cm combi electric oven
- Digital full programmer
- Inox pop-in pop-out knobs
- Inox handle
- Inox control panel
- Side vertical cladding inox add-on oven door



BO.61

FEATURES

- 60 cm combi electric oven
- Rustic style Risus knobs
- Rustic style Risus handle
- Type-C rustic design artwork
- Black glass control panel and oven door



BO.69

FEATURES

- 60 cm combi electric oven
- Digital full programmer
- Inox pop-in pop-out knobs
- Inox handle
- White optical glass control panel and oven door
- Side vertical cladding inox add-on control panel
- Side vertical cladding inox add-on oven door



BO.58

FEATURES

- 60 cm combi electric oven
- Mechanical timer
- White metal control panel
- White painted knobs
- White painted handle
- White painted glass oven door



BO.34

FEATURES

- 60 cm combi electric oven without cooling fan
- White painted knobs
- White handle (without cooling fan type)
- White metal control panel
- Black glass oven door

H O B S



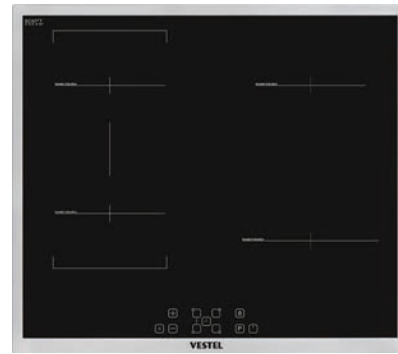

Vestel Induction Hobs

VESTEL 100% Vestel Induction Technology

Easy Touch Easy to Use with touch control unit

High EFFICIENCY High Efficiency with low energy consumption

SAFETY Thermal cut off system
Safe usage with pan detector
The glass surface is not directly heated thanks to the induction technology

Power BOOST Quick heating with PowerBoost

Boiling Fixes the cooking zone in boiling temperature (100°C)

Frying Fixes the cooking zone in frying temperature (160°C)

KEEP Warm Keeps the cooking zone in 50°C

Chocolate MELTING Special function for chocolate melting (40°C)

+++ Bridge Zone +++ This function locks two zones to act as a single zone for using large utensils.

TIMER Cooking duration control with Timer

smart pause Will pause all the cooking in all zones and restart it from the same power levels when pressed again. Keeps the paused zones warm.

KEY LOCK Key lock function is for to block and to set the appliance in a safe mode during operation and cleaning.

Child Lock Safe usage with Child Lock

AutoOFF The hob will shut off automatically if left idle for a long time. (1,5 to 6 hours depending on the power level)

EasyClean Easy to clean thanks to special glass surface

CERAN GLASS DESIGNS

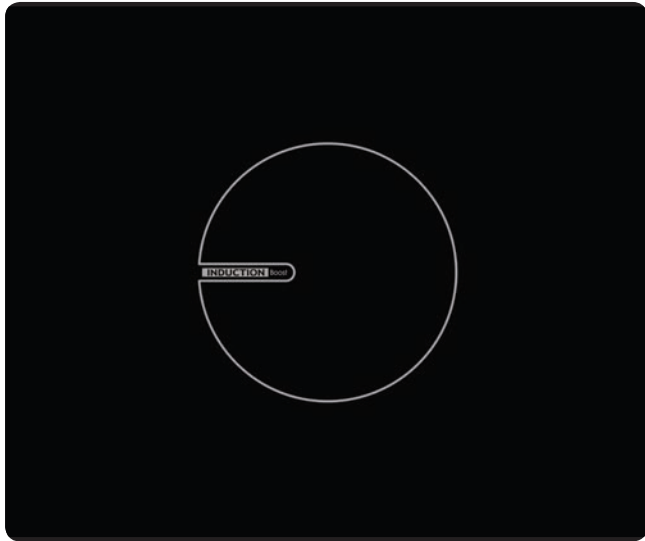

Slim Design (for induction hobs)

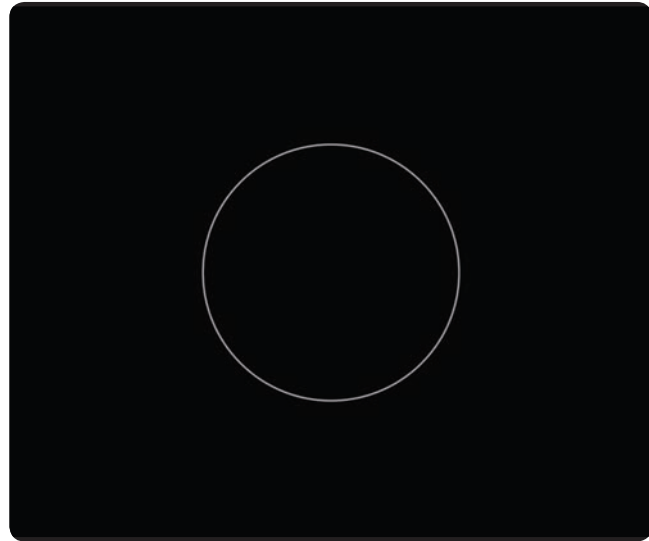

Slim Design for Vitroceramic Hobs

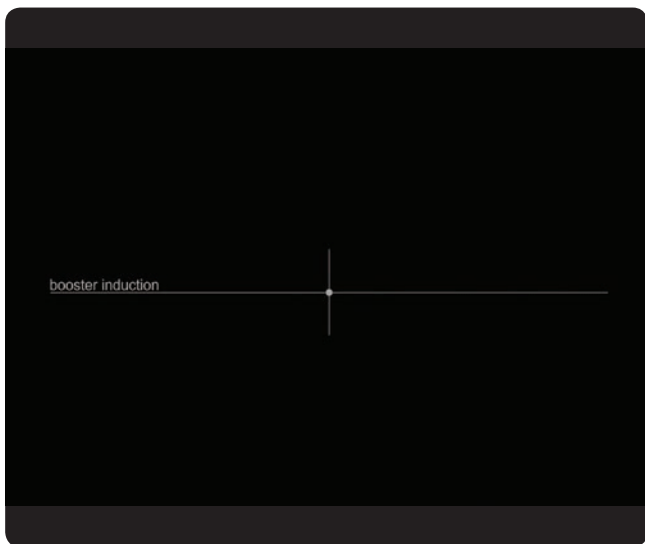

Line Design (for induction hobs)

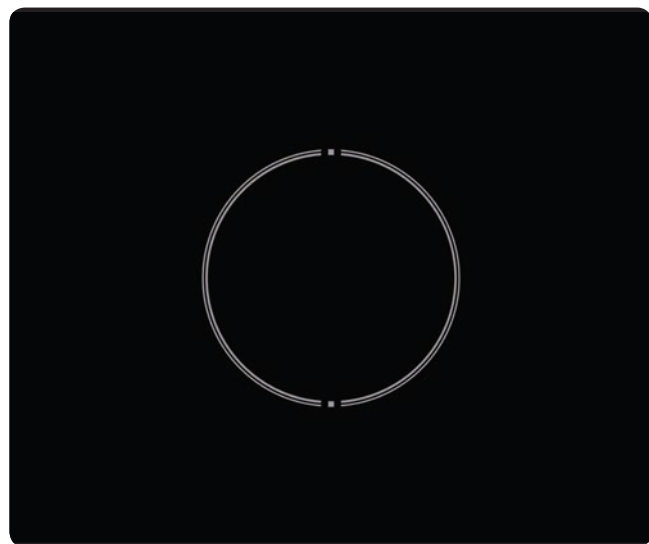

Point Design for Vitroceramic Hobs



Plus Design (for induction hobs)

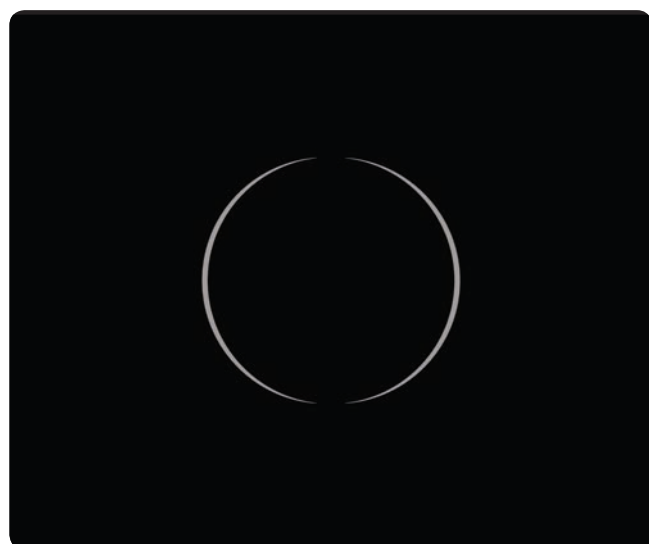

Arc Design for Vitroceramic Hobs



Touch Control Panel for 90cm induction hobs



Slider Touch Control Panel for Slim Design (induction hobs Series II)

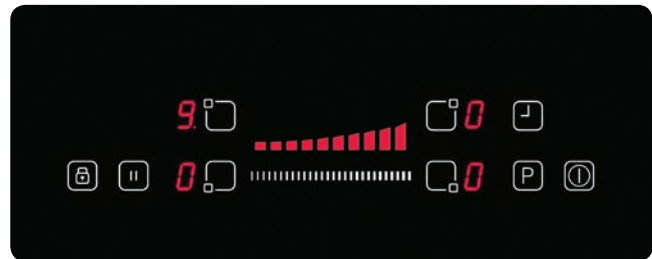

Slider Touch Control Panel-1 (for induction hobs Series II)

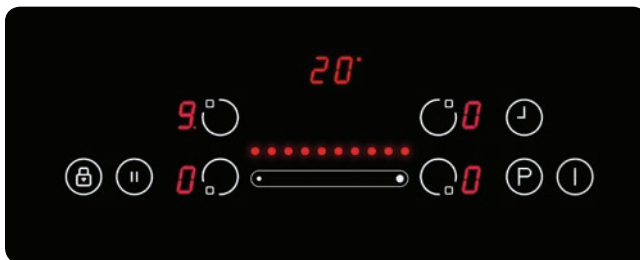

Slider Touch Control Panel-2 (for induction hobs)

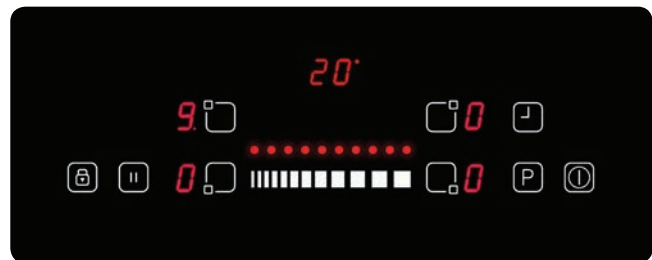

Slider Touch Control Panel-1 (induction hobs)

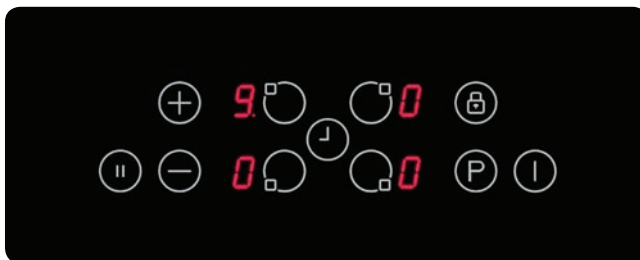

Touch Control Panel for induction hobs

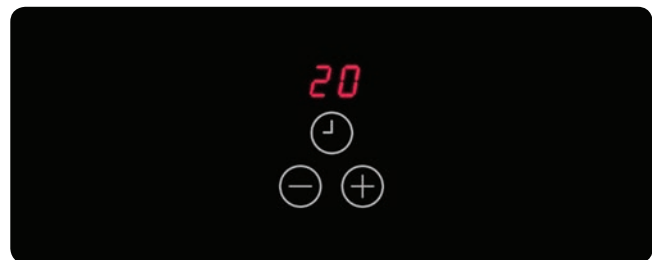

Touch Control Panel for induction poly hobs

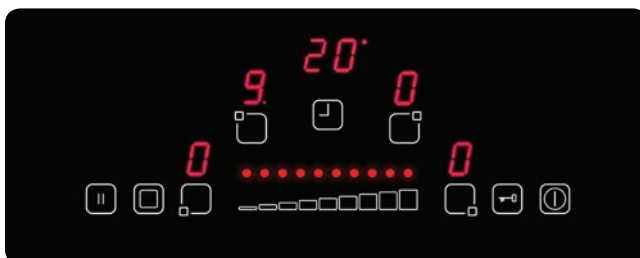

Slider Touch Control Panel (for vitro hobs)

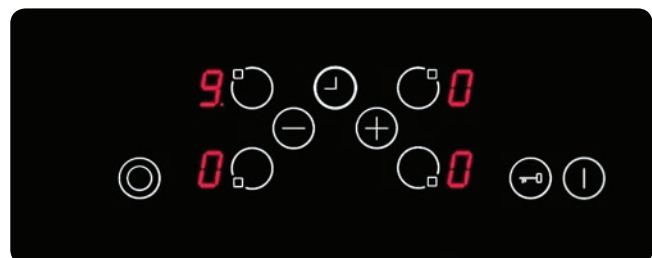

Touch Control Panel for vitroceramic hobs

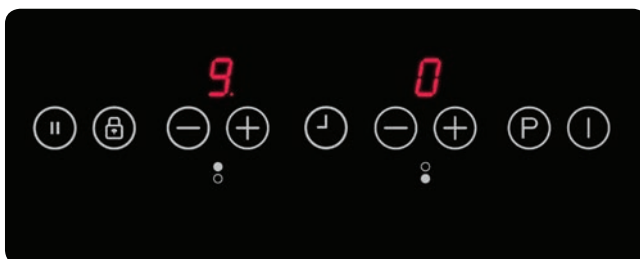

Touch Control Panel for domino induction hobs

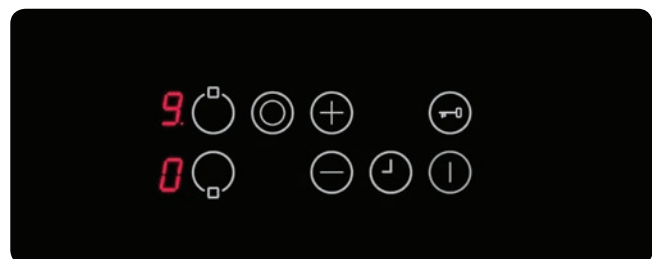

Touch Control Panel for domino vitro hobs

CERAN HOB DETAILS



180 mm Dual Zone For Vitroceramic Hobs

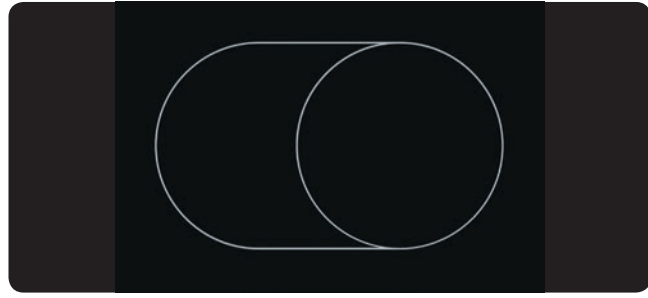

145 mm Oval Zone For Vitroceramic Hobs

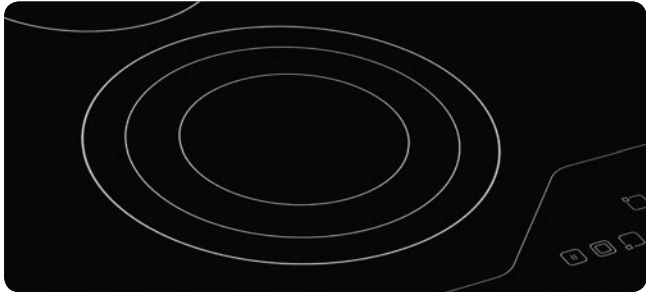

210 mm Triple Zone For Vitroceramic Hobs

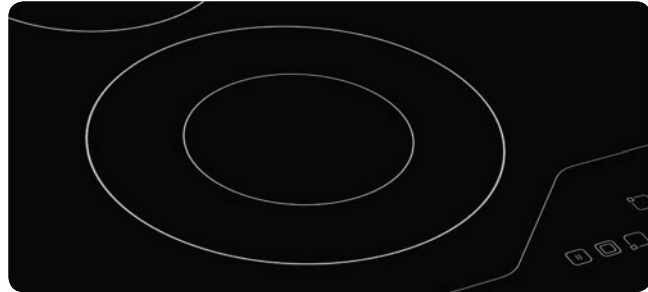

210 mm Zone Dual Zone For Vitroceramic Hobs



210 mm Zone For Vitroceramic Hobs

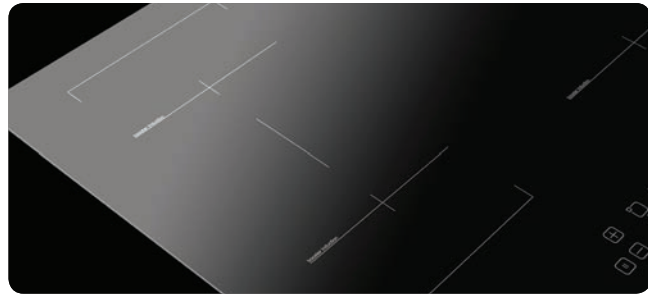

Bridge Zone

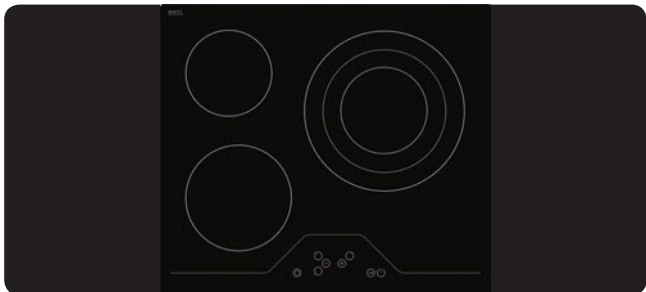

290 mm Triple Zone For Vitroceramic Hobs

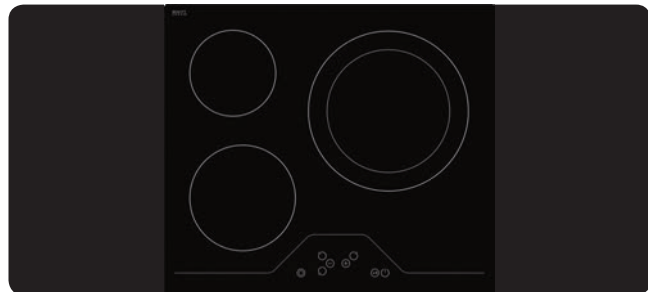

290 mm Dual Zone For Vitroceramic Hobs

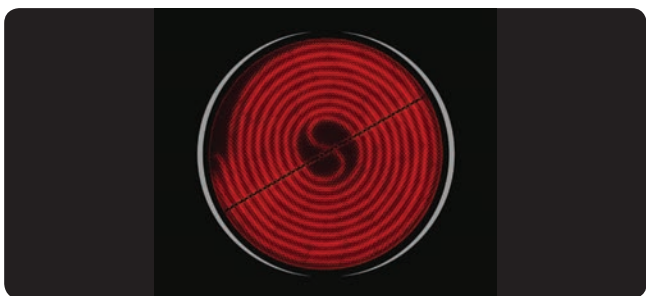

Highlight Heating Element

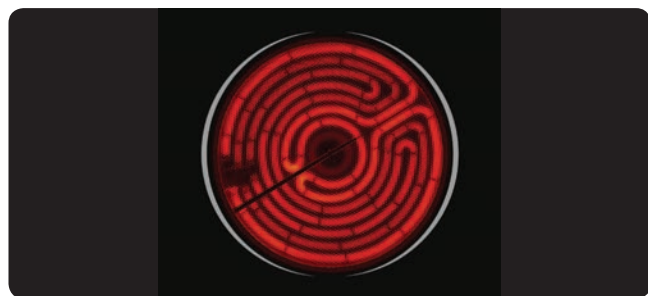

Radiant Heating Element

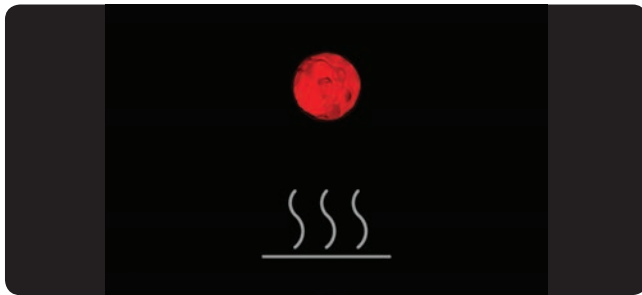

Hot Surface Indicator Light For Vitroceramic Hobs

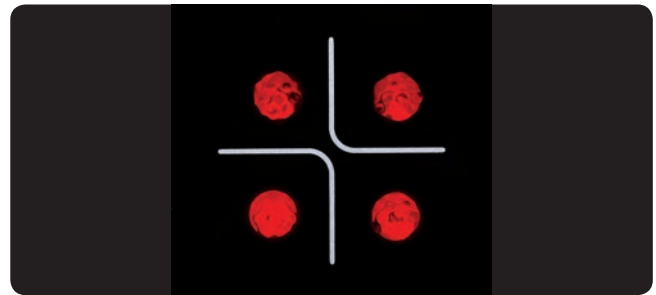

Hot Surface Indicators For Vitroceramic Hobs

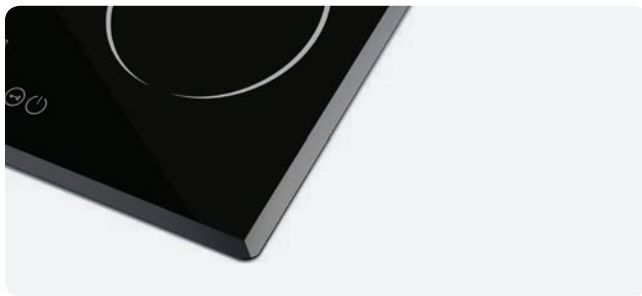

Bevelled Edges For Vitroceramic Hobs

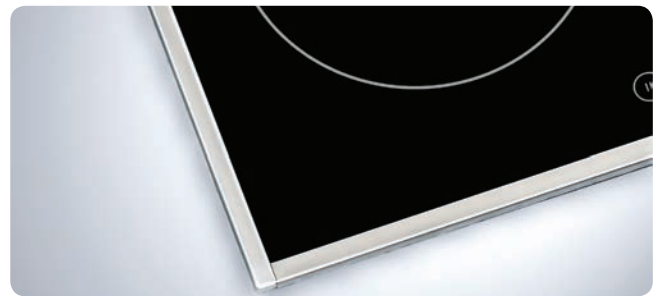

Inox Frame

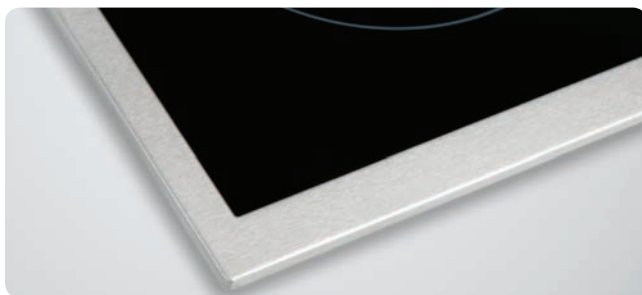

Full Inox Frame

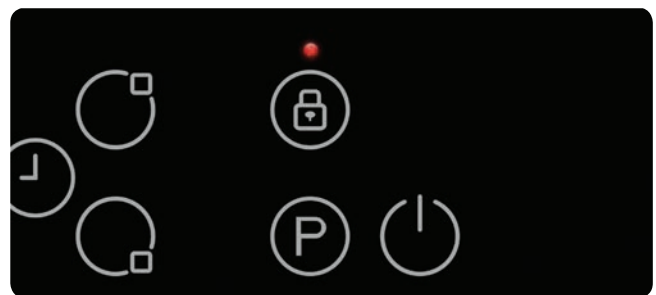

Key Lock For Induction Hobs

GAS ON GLASS HOB PAN SUPPORT TYPES



Standard type enamel pan support



PlusX type Enamel Pan Support



Standard type mat enamel pan support



PlusX type mat enamel pan support



Standard type cast iron pan support



PlusX type cast iron pan support



Profile type enamel pan support



Line Pan Supports (Gas On Glass)

GAS ON GLASS HOB PAN SUPPORT TYPES



Line type cast iron pan support for 60cm PlusX hob



Line type cast iron pan support for 70cm PlusX hob



Deluxe type cast iron pan support for 60cm PlusX hob



Deluxe type cast iron pan support for 70cm PlusX hob



Division type cast iron pan support



S type cast iron pan support (only 90cm hob)

PAN SUPPORT TYPES



S-Type



V-Type



D-Type



O-Type



K-Type



S-Type Cast Iron



K-Type Cast Iron (60cm)



K-Type Cast Iron (70cm)



S-Type Cast Iron (PlusX 60cm)



S-Type Cast Iron (PlusX 70cm)



Extenda Cast Iron



Division Cast Iron



Enamel Pan Supports



Mat Enamel Pan Supports



Cast Iron Pan Supports



Enamel Burner Pan And Enamel Pan Support For Gas On Glass Hobs



Mat Enamel Burner Pan And Cast Iron Pan Support For Gas On Glass Hobs



Inox Burner Pan And Mat Enamel Pan Supports For Gas On Glass Hobs



Enamel Burner Cap



Enamel Flat Burner Cap



Mat Enamel Burner Cap



Cast Iron Burner Cap



Coffie Support



Cast Iron Coffee Support

HOB DETAILS



Ignition for Gas Burners



Flame Failure Device for Gas Burners



Semi Flat Burner

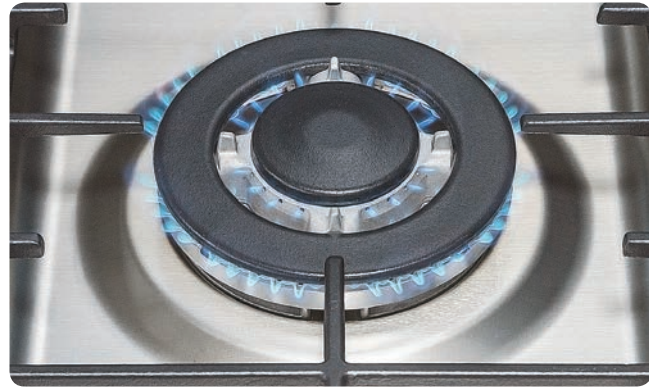

Wok Burner



High Efficiency Wok Burner (for 90cm gas on glass hob)



Main Valve Button (for 90 cm gas on glass hob)



Button Ignition for Gas Hobs



Rapid Solid Hotplate



Mechanical Timer for Domino Hobs



Enamel Wok Adapter



Cast Iron Wok Adapter



Cast Iron Wok Adapter for High Efficiency Wok Burner
(only 90cm gas on glass hob)

HOB SPECIFICATIONS

BUILT-IN/TABLE-TOP HOB SPECIFICATION SHEET		BI Gas/Combined Hobs							
		60 CM	60 CM	60 CM	60 CM	60 CM	60 CM	70 CM	70 CM
		Flat/Surface	Extenda	Classic	Model I	PlusX	Division	Model I	PlusX
Available Colours									
White		Standard	Standard	Standard	Standard	Standard	-	Standard	Standard
Brown		Optional	Optional	Optional	Optional	Optional	-	Optional	Optional
Terre de France		Optional	Optional	Optional	Optional	Optional	-	Optional	Optional
Black		Optional	Optional	Optional	Optional	Optional	-	Optional	Optional
Dark Green		Optional	Optional	Optional	Optional	Optional	-	Optional	Optional
Stainless Steel		Optional	Optional	Optional	Optional	Optional	Standard	Optional	Optional
Product Dimensions									
Height (max., varies from model to model)	mm	40	40	40	39,5	42	42	39,5	42
Width	mm	580	580	580	590	580	580	680	700
Depth (max., do not include gas connection detail)	mm	510	510	510	515	515	510	515	515
Cut-out Dimensions									
Width	mm	560	560	560	560	560	560	560	560
Depth	mm	490	490	490	490	490	490	490	490
Hob Features									
Hob		Enamel/ Stainless Steel	Enamel/ Stainless Steel	Enamel/ Stainless Steel	Enamel/ Stainless Steel	Enamel/ Stainless Steel	Stainless Steel	Enamel/ Stainless Steel	Enamel/ Stainless Steel
Rapid Gas Burner Ø10cm	W	3000	3000	3000	3000	3000	3000	3000	3000
Semi-rapid Gas Burner Ø7.5cm	W	1750	1750	1750	1750	1750	1750	1750	1750
Auxiliary Gas Burner Ø5.5cm	W	1000	1000	1000	1000	1000	1000	1000	1000
Wok (Triple Flame) Gas Burner Mono Ø14cm	W	3600	3600	3600	3600	-	-	3600	3600
Wok (Triple Flame) Gas Burner Dual Ø14cm	W	-	-	-	-	-	-	-	-
Wok (Triple Flame) Gas Burner Ø11cm	W	-	-	-	-	3200	-	-	-
Ø145 mm Hotplate	W	-	-	1000	1000	1000	-	1000	1000
Ø180 mm Hotplate	W	1500	1500	-	-	-	-	-	-
Ø145 mm Rapid Hotplate	W	-	-	-	-	-	-	-	-
Ø180 mm Rapid Hotplate	W	-	-	-	-	-	-	-	-
Ø145 mm Highlight Element	W	-	-	-	-	-	-	-	-
Ø180 mm Highlight Element	W	-	-	-	-	-	-	-	-
Ø210 mm Highlight Element	W	-	-	-	-	-	-	-	-
Ø180 mm Dual Highlight Element	W	-	-	-	-	-	-	-	-
Ø145 mm Oval Highlight Element	W	-	-	-	-	-	-	-	-
Ø210 mm Dual Highlight Element	W	-	-	-	-	-	-	-	-
Ø210 mm Triple Highlight Element	W	-	-	-	-	-	-	-	-
Ø290 mm Dual/ Triple Highlight Element	W	-	-	-	-	-	-	-	-
Ø160 mm Induction Zone (Serie 1 and Serie 2)	W	-	-	-	-	-	-	-	-
Ø200 mm Induction Zone (Serie 1)	W	-	-	-	-	-	-	-	-
Ø210 mm Induction Zone (Serie 2)	W	-	-	-	-	-	-	-	-
Ø250 mm Induction Zone (Serie 1)	W	-	-	-	-	-	-	-	-
Ø290 mm Induction Zone (Serie 2)	W	-	-	-	-	-	-	-	-
Boost Function	-	-	-	-	-	-	-	-	-
Pot Dedection	-	-	-	-	-	-	-	-	-
Automatic Heatup	-	-	-	-	-	-	-	-	-
Timer function for vitro ceramic hobs (If touch control with some hob configuration selected)	-	-	-	-	-	-	-	-	-
Mode function for induction ceramic hobs (If touch control with some hob configuration selected)	-	-	-	-	-	-	-	-	-
Bridge zone for induction ceramic hobs (If touch control with some hob configuration selected)	-	-	-	-	-	-	-	-	-
Child Lock for vitro ceramic hobs (If touch control selected)	-	-	-	-	-	-	-	-	-
Mechanical Child Lock (Main Switch)	-	-	-	-	-	-	-	-	-
Hot Surface Indicator Light	-	-	-	-	-	-	-	-	-
Hotplate Operation Indicator Light	-	Standard	Standard	Standard	Standard	Standard	-	Standard	Standard
Side Knob Control	-	Standard	Standard	Standard	-	-	-	-	-
Side Touch Control	-	-	-	-	-	-	-	-	-
Front Knob Control	-	-	-	-	Standard	Standard	-	Standard	Standard
Double Side Front Control	-	-	-	-	-	-	Standard	-	-
Front Triangular Touch Control	-	-	-	-	-	-	-	-	-
Front Slider Touch Control	-	-	-	-	-	-	-	-	-
Front Touch Control	-	-	-	-	-	-	-	-	-
Bevelled Edges	-	-	-	-	-	-	-	-	-
Logo	-	Standard	Standard	Standard	Standard	Standard	Standard	Standard	Standard
Special Decoration on Glass	-	-	-	-	-	-	-	-	-
Vitroceramic Glass Artwork	-	-	-	-	-	-	-	-	-
Inox Frame	-	-	-	-	-	-	-	-	-
Stainless Steel Burner Pan	-	-	-	-	-	-	-	-	-
Table Top Installation (not built-in)	-	Optional	Optional	Optional	-	-	-	-	-
Glass Lid	-	-	-	-	-	-	-	-	-
Burner Safety Valves	-	Standard	Standard	Standard	Standard	Standard	Standard	Standard	Standard
Button Ignition	-	Optional	Optional	Optional	Optional	-	-	Optional	-
One-touch-Ignition through knobs	-	Optional	Optional	Optional	Optional	Optional	Standard	Optional	Optional
Enamel Pan Supports	-	Standard	Standard	Standard	Standard	Standard	-	Standard	Standard
Cast Iron Pan Supports	-	Optional	Optional	-	Optional	Optional	Standard	Optional	Optional
Cast Iron Burner Caps	-	Optional	Optional	-	Optional	Optional	Optional	Optional	Optional
Coffee Adaptor	-	Optional	Optional	Optional	Optional	Optional	Optional	Optional	Optional
Wok Adaptor	-	Optional	Optional	Optional	Optional	Optional	-	Optional	Optional
Vitroceramic Glass Cleaning Spatula	-	-	-	-	-	-	-	-	-
Gas Conversion Kit	-	Standard	Standard	Standard	Standard	Standard	Standard	Standard	Standard
Others									
Total Gas Power (Depends on Model) Maximum	kW	8,1	8,1	8,1	8,1	7,7	7,5	11,1	11,1
Total Electric Power (Depends on Model) Maximum	kW	1,5	1,5	1	1	1	-	1	1
Voltage	V	230V~	230V~	230V~	230V~	230V~	230V~	230V~	230V~
RoHS Compliance	-	Standard	Standard	Standard	Standard	Standard	Standard	Standard	Standard
CE Compliance	-	Standard	Standard	Standard	Standard	Standard	Standard	Standard	Standard
Carton Box Packaging	-	Standard	Standard	Standard	Standard	Standard	Standard	Standard	Standard
Packed Product Dimensions (WxDxH)	mm	626 x 580 x 140	x	626 x 560 x 130	641 x 576 x 161	x	x	731 x 576 x 161	x
Packed Product Dimensions (WxDxH) Box	mm	640 x 584 x 152	647 x 582 x 164	635 x 564 x 142	x	647 x 582 x 164	647 x 582 x 164	x	769 x 582 x 164
Net Weight (Depends on Model) Maximum	kg	9	9,5	6,6	9,8	9,5	11	10,7	12,5
Gross Weight (Depends on Model) Maximum	kg	9,75	10,5	7,5	10,6	10,5	12	11,6	13,5

HOB SPECIFICATIONS

BUILT-IN/TABLE-TOP HOB SPECIFICATION SHEET	BI Gas Securit Hobs								
	60 CM	60 CM	60 CM	60 CM	60 CM	70 CM	70 CM	90 CM	
	Securit II	Trio	Model I	PlusX	Division	Model I	PlusX		
Available Colours									
White	Optional	Optional	Optional	Optional	-	Optional	Optional	Optional	
Brown	Optional	Optional	Optional	Optional	-	Optional	Optional	Optional	
Terre de France	Optional	Optional	Optional	Optional	-	Optional	Optional	Optional	
Black	Standard	Standard	Standard	Standard	Standard	Standard	Standard	STANDARD	
Dark Green	Optional	Optional	Optional	Optional	-	Optional	Optional	Optional	
Stainless Steel	-	-	-	-	-	-	-	-	
Product Dimensions									
Height (max., varies from model to model)	mm	44	44	39,5	44	44	39,5	44	47
Width	mm	594	594	590	594	594	680	700	882
Depth (max., do not include gas connection detail)	mm	523	523	515	523	523	515	520	520
Cut-out Dimensions									
Width	mm	560	560	560	560	560	560	560	850
Depth	mm	490	490	490	490	490	490	490	480
Hob Features									
Hob		Securit	Securit	Securit	Securit	Securit	Securit	Securit	Securit
Rapid Gas Burner Ø10cm	W	3000	3000	3000	3000	3000	3000	3000	3000
Semi-rapid Gas Burner Ø7.5cm	W	1750	1750	1750	1750	1750	1750	1750	1750
Auxiliary Gas Burner Ø5.5cm	W	1000	1000	1000	1000	1000	1000	1000	1000
Wok (Triple Flame) Gas Burner Mono Ø14cm	W	3600	3600	3600	3600	-	3600	3600	4500
Wok (Triple Flame) Gas Burner Dual Ø14cm	W	-	-	-	-	-	-	-	4500
Wok (Triple Flame) Gas Burner Ø11cm	W	-	-	-	-	-	-	-	-
Ø145 mm Hotplate	W	-	-	-	1000	-	-	-	-
Ø180 mm Hotplate	W	-	-	-	-	-	-	-	-
Ø145 mm Rapid Hotplate	W	-	-	-	-	-	-	-	-
Ø180 mm Rapid Hotplate	W	-	-	-	-	-	-	-	-
Ø145 mm Highlight Element	W	-	-	-	-	-	-	-	-
Ø180 mm Highlight Element	W	-	-	-	-	-	-	-	-
Ø210 mm Highlight Element	W	-	-	-	-	-	-	-	-
Ø180 mm Dual Highlight Element	W	-	-	-	-	-	-	-	-
Ø145 mm Oval Highlight Element	W	-	-	-	-	-	-	-	-
Ø210 mm Dual Highlight Element	W	-	-	-	-	-	-	-	-
Ø210 mm Triple Highlight Element	W	-	-	-	-	-	-	-	-
Ø290 mm Dual/Triple Highlight Element	W	-	-	-	-	-	-	-	-
Ø160 mm Induction Zone (Serie 1 and Serie 2)	W	-	-	-	-	-	-	-	-
Ø200 mm Induction Zone (Serie 1)	W	-	-	-	-	-	-	-	-
Ø210 mm Induction Zone (Serie 2)	W	-	-	-	-	-	-	-	-
Ø250 mm Induction Zone (Serie 1)	W	-	-	-	-	-	-	-	-
Ø290 mm Induction Zone (Serie 2)	W	-	-	-	-	-	-	-	-
Boost Funcion		-	-	-	-	-	-	-	-
Pot Dedection		-	-	-	-	-	-	-	-
Automatic Heatup		-	-	-	-	-	-	-	-
Timer function for vitro ceramic hobs (If touch control with some hob configuration selected)		-	-	-	-	-	-	-	-
Mode function for induction ceramic hobs (If touch control with some hob configuration selected)		-	-	-	-	-	-	-	-
Bridge zone for induction ceramic hobs (If touch control with some hob configuration selected)		-	-	-	-	-	-	-	-
Child Lock for vitro ceramic hobs (If touch control selected)		-	-	-	-	-	-	-	-
Mechanical Child Lock (Main Switch)		-	-	-	-	-	-	-	Optional
Hot Surface Indicator Light		-	-	-	-	-	-	-	-
Hotplate Operation Indicator Light		-	-	Standard	Standard	-	-	-	-
Side Knob Control		Standard	Standard	-	-	-	-	-	-
Side Touch Control		-	-	-	-	-	-	-	-
Front Knob Control		-	-	Standard	Standard	-	-	-	-
Double Side Front Control		-	-	-	-	Standard	-	-	-
Front Triangular Touch Control		-	-	-	-	-	-	-	-
Front Slider Touch Control		-	-	-	-	-	-	-	-
Front Touch Control		-	-	-	-	-	-	-	-
Bevelled Edges		-	-	-	-	-	-	-	Optional
Logo		Optional	Optional	STANDARD	STANDARD	Standard	STANDARD	STANDARD	STANDARD
Special Decoration on Glass		Optional	Optional	-	-	-	-	-	-
Vitroceraamic Glass Artwork		-	-	-	-	-	-	-	-
Inox Frame		-	-	STANDARD	-	-	STANDARD	-	Optional
Stainless Steel Burner Pan		Optional	Optional	Optional	Optional	-	Optional	Optional	Optional
Table Top Installation (not built-in)		-	-	-	-	-	-	-	-
Glass Lid		-	-	-	-	-	-	-	-
Burner Safety Valves		Standard	Standard	Standard	Standard	Standard	Standard	Standard	STANDARD
Button Ignition		Optional	Optional	Optional	-	-	Optional	-	-
One-touch-Ignition through knobs		Optional	Optional	Optional	Optional	Standard	Optional	Optional	STANDARD
Enamel Pan Supports		Standard	Standard	Standard	Standard	-	Standard	Standard	-
Cast Iron Pan Supports		Optional	Optional	Optional	Optional	Standard	Optional	Optional	STANDARD
Cast Iron Burner Caps		Optional	Optional	Optional	Optional	Optional	Optional	Optional	STANDARD
Coffee Adaptor		Optional	Optional	Optional	Optional	Optional	Optional	Optional	Optional
Wok Adaptor		Optional	Optional	Optional	Optional	-	Optional	Optional	Optional
Vitroceraamic Glass Cleaning Spatula		-	-	-	-	-	-	-	-
Gas Conversion Kit		Standard	Standard	Standard	Standard	Standard	Standard	Standard	Optional
Others									
Total Gas Power (Depends on Model) Maximum	kW	8,1	8,1	8,1	8,1	7,5	11,1	11,1	12
Total Electric Power (Depends on Model) Maximum	kW	-	-	-	1	-	-	-	-
Voltage	V	230V~	230V~	230V~	230V~	230V~	230V~	230V~	230V~
RoHS Compliance		Standard	Standard	Standard	Standard	Standard	Standard	Standard	Standard
CE Compliance		Standard	Standard	Standard	Standard	Standard	Standard	Standard	Standard
Carton Box Packaging		Standard	Standard	Standard	Standard	Standard	Standard	Standard	Standard
Packed Product Dimensions (WxDxH)	mm	622 x 580 x 140	622 x 580 x 140	641 x 576 x 161	x	x	731 x 576 x 161	x	x
Packed Product Dimensions (WxDxH) Box	mm	x	x	x	647 x 582 x 164	647 x 582 x 164	x	769 x 582 x 164	935 x 582 x 164
Net Weight (Depends on Model) Maximum	kg	9,5	9,5	10,7	11,5	-	13,7	13,8	20,5
Gross Weight (Depends on Model) Maximum	kg	10,25	10,25	11,13	12,5	-	14,2	14,8	21,5

HOB SPECIFICATIONS

BUILT-IN/ TABLE-TOP HOB SPECIFICATION SHEET		BI Electric Hobs		BI Vitro Ceramic Hobs		BI Induction Ceramic Hobs			
		60 CM		60 CM	78 CM	60 CM		78 CM	90CM
		Flat/Surface		C Serie	C Serie	Vestel Induction	Vestel Induction	Vestel Induction	
Available Colours									
White		Standard	Optional	Optional	Optional	Optional	Optional		
Brown		Optional	-	-	-	-	-		
Terre de France		Optional	-	-	-	-	-		
Black		Optional	Standard	Standard	Standard	Standard	Standard		
Dark Green		Optional	-	-	-	-	-		
Stainless Steel		Optional	-	-	-	-	-		
Product Dimensions									
Height (max., varies from model to model)	mm	40	41- 47,5	41	56	56	56		
Width	mm	580	590	780	590	590	890		
Depth (max., do not include gas connection detail)	mm	510	520	520	520	520	520		
Cut-out Dimensions									
Width	mm	560	560	750	560	750	860		
Depth	mm	490	490	490	490	490	490		
Hob Features									
Hob		Enamel/Stainless Steel	Vitro Ceramic	Vitro Ceramic	Induction Ceramic	Induction Ceramic	Induction Ceramic		
Rapid Gas Burner Ø10cm	W	-	-	-	-	-	-		
Semi-rapid Gas Burner Ø7.5cm	W	-	-	-	-	-	-		
Auxiliary Gas Burner Ø5.5cm	W	-	-	-	-	-	-		
Wok (Triple Flame) Gas Burner Mono Ø14cm	W	-	-	-	-	-	-		
Wok (Triple Flame) Gas Burner Dual Ø14cm	W	-	-	-	-	-	-		
Wok (Triple Flame) Gas Burner Ø11cm	W	-	-	-	-	-	-		
Ø145 mm Hotplate	W	1000	-	-	-	-	-		
Ø180 mm Hotplate	W	1500	-	-	-	-	-		
Ø145 mm Rapid Hotplate	W	1500	-	-	-	-	-		
Ø180 mm Rapid Hotplate	W	2000	-	-	-	-	-		
Ø145 mm Highlight Element	W	-	1200	1200	-	-	-		
Ø180 mm Highlight Element	W	-	1800	1800	-	-	-		
Ø210 mm Highlight Element	W	-	2300	2300	-	-	-		
Ø180 mm Dual Highlight Element	W	-	1700	1700	-	-	-		
Ø145 mm Oval Highlight Element	W	-	1800	1800	-	-	-		
Ø210 mm Dual Highlight Element	W	-	2200	2200	-	-	-		
Ø210 mm Triple Highlight Element	W	-	2300	2300	-	-	-		
Ø290 mm Dual/Triple Highlight Element	W	-	2700	-	-	-	-		
Ø160 mm Induction Zone (Serie 1 and Serie 2)	W	-	-	-	Nominal 1400 W max. Boost 1800 W	Nominal 1400 W max. Boost 1800 W	Nominal 1400 W max. Boost 1800 W		
Ø200 mm Induction Zone (Serie 1)	W	-	-	-	Nominal 2100 W max. Boost 2500 W	Nominal 2100 W max. Boost 2500 W	Nominal 2100 W max. Boost 2500 W		
Ø210 mm Induction Zone (Serie 2)	W	-	-	-	Nominal 2100 W max. Boost 2500 W	-	-		
Ø250 mm Induction Zone (Serie 1)	W	-	-	-	Nominal 2800 W max. Boost 3500 W	Nominal 2800 W max. Boost 3500 W	Nominal 2800 W max. Boost 3500 W		
Ø290 mm Induction Zone (Serie 2)	W	-	-	-	Nominal 2800 W max. Boost 3500 W	-	-		
Boost Function		-	-	-	Standard	Standard	Standard		
Pot Dedection		-	-	-	Standard	Standard	Standard		
Automatic Heatup		-	-	-	-	-	-		
Timer function for vitro ceramic hobs (If touch control with some hob configuration selected)		-	Optional	Optional	Optional	Optional	Standard		
Mode function for induction ceramic hobs (If touch control with some hob configuration selected)		-	-	-	Optional	Optional	-		
Bridge zone for induction ceramic hobs (If touch control with some hob configuration selected)		-	-	-	Optional	-	-		
Child Lock for vitro ceramic hobs (If touch control selected)		-	Standard	Standard	Standard	Standard	Standard		
Mechanical Child Lock (Main Switch)		-	-	-	-	-	-		
Hot Surface Indicator Light		-	Standard	Standard	Standard	Standard	Standard		
Hotplate Operation Indicator Light		Standard	-	-	-	-	-		
Side Knob Control		Standard	Standard	-	-	-	-		
Side Touch Control		-	Optional	-	-	-	-		
Front Knob Control		-	-	-	-	-	-		
Double Side Front Control		-	-	-	-	-	-		
Front Triangular Touch Control		-	Optional	Standard	-	-	-		
Front Slider Touch Control		-	Optional	Optional	Optional	Optional	-		
Front Touch Control		-	-	-	Optional	Optional	Optional		
Bevelled Edges		-	Optional	Optional	Optional	Optional	Optional		
Logo		Standard	Optional	Optional	Optional	Optional	Optional		
Special Decoration on Glass		-	Optional	Optional	Optional	Optional	Optional		
Vitroceramic Glass Artwork		-	Slim/ Arc/ Point	Slim/ Arc/ Point	Slim/ Plus/ Line	Slim/ Plus/ Line	Slim/ Plus/ Line		
Inox Frame		-	Optional	-	Optional	Optional	Optional		
Stainless Steel Burner Pan		-	-	-	-	-	-		
Table Top Installation (not built-in)		-	-	-	-	-	-		
Glass Lid		-	-	-	-	-	-		
Burner Safety Valves		-	-	-	-	-	-		
Button Ignition		-	-	-	-	-	-		
One-touch-Ignition through knobs		-	-	-	-	-	-		
Enamel Pan Supports		-	-	-	-	-	-		
Cast Iron Pan Supports		-	-	-	-	-	-		
Cast Iron Burner Caps		-	-	-	-	-	-		
Coffee Adaptor		-	-	-	-	-	-		
Wok Adaptor		-	-	-	-	-	-		
Vitroceramic Glass Cleaning Spatula		-	Optional	Optional	Optional	Optional	Optional		
Gas Conversion Kit		-	-	-	-	-	-		
Others									
Total Gas Power (Depends on Model) Maximum	kW	-	-	8,3	-	-	-		
Total Electric Power (Depends on Model) Maximum	kW	6	6,5	8,3	7,4	7,4	10,8		
Voltage	V	230V~/400V 2N~	230V~/400V 3N~	230V~/400V 3N~	230V~/400V 3N~	230V~/400V 3N~	230V~/400V 3N~		
RaHS Compliance		Standard	Standard	Standard	Standard	Standard	Standard		
CE Compliance		Standard	Standard	Standard	Standard	Standard	Standard		
Carton Box Packaging		Standard	Standard	Standard	Standard	Standard	Standard		
Packed Product Dimensions (WxDxH)	mm	626 x 580 x 140	620 x 578 x 133	810 x 578 x 133	626 x 581 x 142	816 x 581 x 142	926 x 581 x 142		
Packed Product Dimensions (WxDxH) Box	mm	640 x 584 x 152	631 x 580 x 143	x	643 x 583 x 152	x	941 x 583 x 152		
Net Weight (Depends on Model) Maximum	kg	9,5	9,5	10,15	11	12	16		
Gross Weight (Depends on Model) Maximum	kg	10,25	10,25	11	12	13	17		



VIFTC.16

STANDARD FEATURES

- 90 cm induction ceramic hob
- Front touch control
- Booster function
- 2 Ø 160 mm 1400 W/Boost 1800 W induction element
- 2 Ø 200 mm 2100 W/Boost 2500 W induction element
- 1Ø250mm2800W/Boost 3500 W induction element
- Pot detection
- Child lock

- Hot surface indicator
- Timer
- Slim design ceran glass serigraphy
- Key Lock Smart Pause

OPTIONAL FEATURES

- Two side inox frame

VIFTC.19

STANDARD FEATURES

- 90 cm induction ceramic hob
- Front touch control
- Booster function
- 2 Ø 160 mm 1400 W/Boost 1800 W induction element
- 2 Ø 200 mm 2100 W/Boost 2500 W induction element
- 1 Ø 250 mm 2800 W/Boost 3500 W induction element
- Pot detection

- Child lock
- Hot surface indicator
- Timer
- Key Lock
- Smart Pause

OPTIONAL FEATURES

- Front side bevelled edge glass

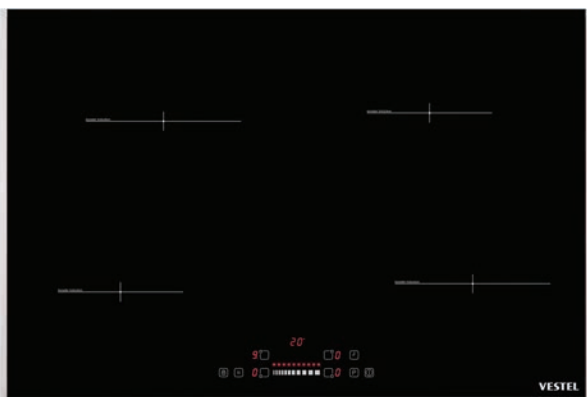

VIFTC.01

STANDARD FEATURES

- 78 cm induction ceramic hob
- Booster function
- 2 Ø 160 mm 1400 W/Boost 1800 W induction element
- 2 Ø 200 mm 2100 W/Boost 2500 W induction element
- Pot detection
- Key lock
- Child lock
- Hot surface indicator
- Smart Pause

OPTIONAL FEATURES

- Slider touch control
- Timer
- Two side inox frame Front side bevelled edge glass
- Mode function

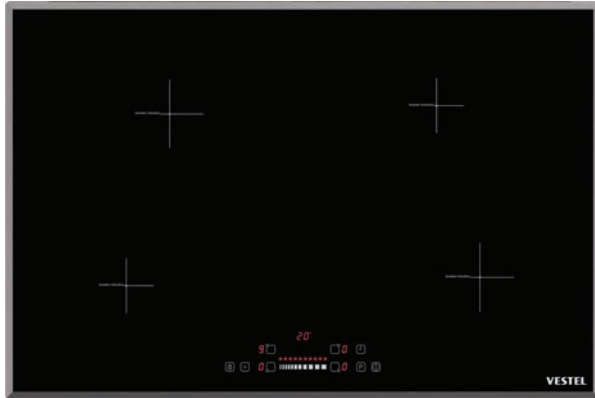

VIFTC.02

STANDARD FEATURES

- 78 cm induction ceramic hob
- Booster function
- 2 Ø 160 mm 1400 W/Boost 1800 W induction element
- 2 Ø 200 mm 2100 W/Boost 2500 W induction element
- Pot detection
- Key lock
- Child lock
- Hot surface indicator
- Smart Pause

OPTIONAL FEATURES

- Slider touch control
- Timer
- Bevelled edge glass
- Mode function

VIFTC.05

STANDARD FEATURES

- 78 cm induction ceramic hob
- Front touch control
- Booster function
- 2 Ø 160 mm 1400 W/Boost 1800 W induction element
- 2 Ø 200 mm 2100 W/Boost 2500 W induction element
- Pot detection
- Key lock
- Child lock

- Hot surface indicator
- Smart Pause

OPTIONAL FEATURES

- Timer
- Bevelled edge glass

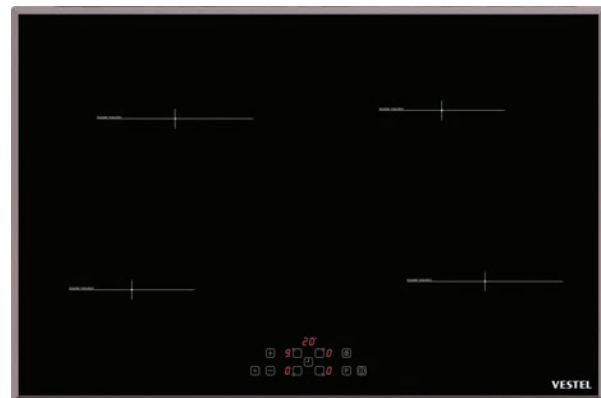

VIFTC.06

STANDARD FEATURES

- 78 cm induction ceramic hob
- Front touch control
- Booster function
- 2 Ø 160 mm 1400 W/Boost 1800 W induction element
- 2 Ø 200 mm 2100 W/Boost 2500 W induction element
- Pot detection
- Key lock
- Child lock

- Hot surface indicator
- Smart Pause

OPTIONAL FEATURES

- Timer
- Two side inox frame
- Mode function

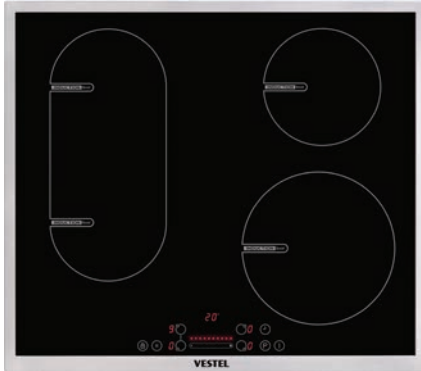

VIFTC.18

STANDARD FEATURES

- 60 cm induction ceramic hob
- Booster function
- 3 Ø 160 mm 1400 W/Boost 1800 W induction element
- 1 Ø 210 mm 2100 W/Boost 2500 W induction element
- Pot Detection
- Child lock
- Hot surface indicator
- Key lock
- Smart pause

OPTIONAL FEATURES

- Slider touch control
- Timer
- Full inox frame
- Birdge zone
- Mode function

VIFTC.08

STANDARD FEATURES

- 60 cm induction ceramic hob
- Booster function
- 2 Ø 160 mm 1400 W/Boost 1800 W induction element
- 2 Ø 210 mm 2100 W/Boost 2500 W induction element
- Pot detection
- Key lock
- Child lock
- Hot surface indicator
- Smart Pause

OPTIONAL FEATURES

- Slider touch control
- Timer
- Two side inox frame
- Front and back side bevelled edge glass
- Mode function

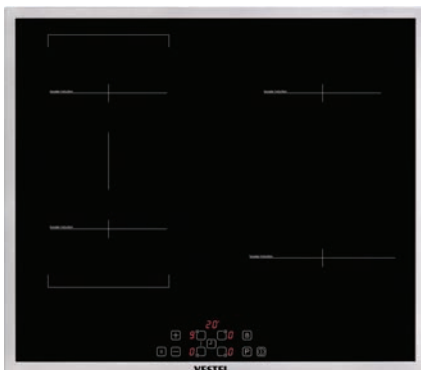
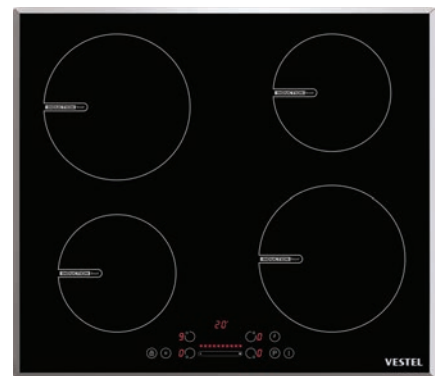

VIFTC.09

STANDARD FEATURES

- 60 cm induction ceramic hob
- Booster function
- 2 Ø 160 mm 1400 W/Boost 1800 W induction element
- 2 Ø 210 mm 2100 W/Boost 2500 W induction element
- Pot detection
- Key lock
- Child lock
- Hot surface indicator
- Smart Pause

OPTIONAL FEATURES

- Slider touch control
- Timer
- Bevelled edge glass
- Mode function

INDUCTION HOBS

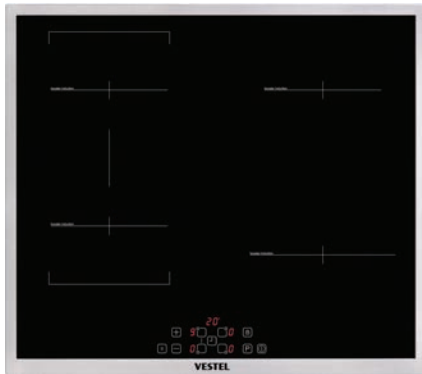

VIFTC.17

STANDARD FEATURES

- 60 cm induction ceramic hob
- Front touch control
- Booster function
- 3 Ø 160 mm 1400 W/Boost 1800 W induction element
- 1 Ø 210 mm 2100 W/Boost 2500 W induction element
- Pot Detection
- Child lock
- Hot surface indicator

- Key lock
- Smart pause

OPTIONAL FEATURES

- Timer
- Full inox frame
- Bridge Zone
- Mode function

VIFTC.12

STANDARD FEATURES

- 60 cm induction ceramic hob
- Front touch control
- Booster function
- 2 Ø 160 mm 1400 W/Boost 1800 W induction element
- 2 Ø 210 mm 2100 W/Boost 2500 W induction element
- Pot detection
- Key lock
- Child lock

- Hot surface indicator
- Smart Pause

OPTIONAL FEATURES

- Inox frame

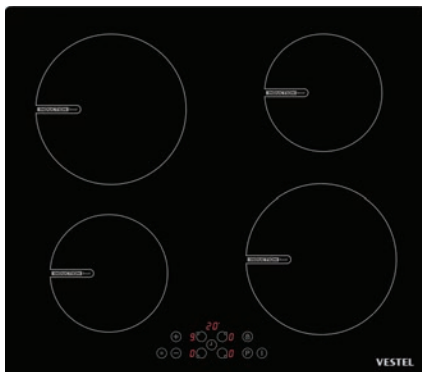

VIFTC.13

STANDARD FEATURES

- 60 cm induction ceramic hob
- Front touch control
- Booster function
- 2 Ø 160 mm 1400 W/Boost 1800 W induction element
- 2 Ø 210 mm 2100 W/Boost 2500 W induction element
- Pot detection
- Key lock
- Child lock

- Hot surface indicator
- Smart Pause

OPTIONAL FEATURES

- Timer
- Mode function

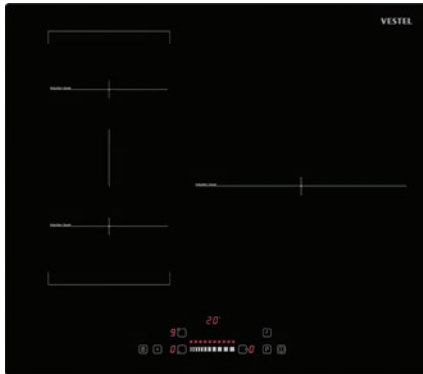

VIFTC.20

STANDARD FEATURES

- 60 cm induction ceramic hob
- Booster function
- 2 Ø 160 mm 1400 W/Boost 1800 W induction element
- 1 Ø 210 mm 2100 W/Boost 2500 W induction element
- Pot Detection
- Child lock
- Hot surface indicator
- Key lock
- Smart pause

OPTIONAL FEATURES

- Slider touch control
- Timer
- Birdge zone
- Mode function

VIFTC.10

STANDARD FEATURES

- 60 cm induction ceramic hob
- Booster function
- 1 Ø 160 mm 1400 W/Boost 1800 W induction element
- 1 Ø 210 mm 2100 W/Boost 2500 W induction element
- 1 Ø 290 mm 2800 W/Boost 3500 W induction element
- Pot detection
- Key lock
- Child lock

- Hot surface indicator
- Smart Pause

OPTIONAL FEATURES

- Slider touch control
- Timer

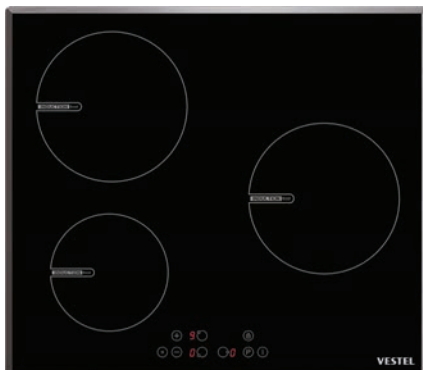
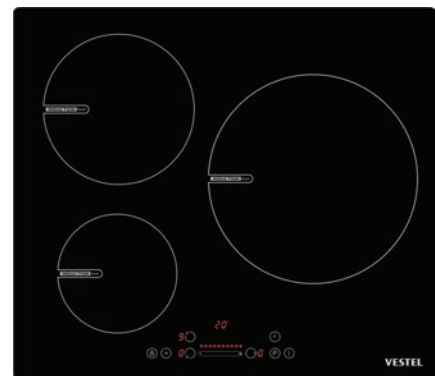

VIFTC.14

STANDARD FEATURES

- 60 cm induction ceramic hob
- Front touch control
- Booster function
- 1 Ø 160 mm 1400 W/Boost 1800 W induction element
- 2 Ø 210 mm 2100 W/Boost 2500 W induction element
- Pot detection
- Key lock
- Child lock

- Hot surface indicator
- Smart Pause

OPTIONAL FEATURES

- Bevelled edge glass

VITROCERAMIC HOBS

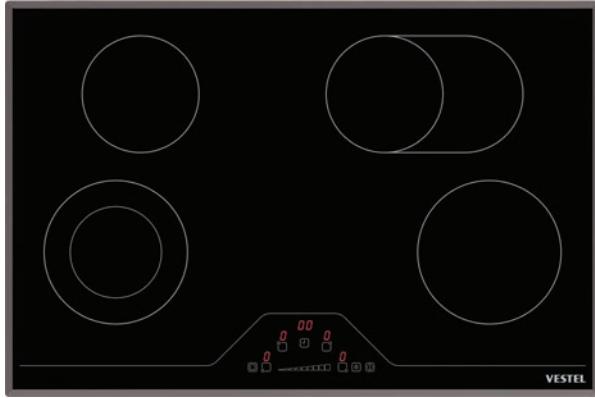

VFTC.01

STANDARD FEATURES

- 78 cm ceramic hob
- 1 Ø 145 mm Highlight Element 1200W
- 1 Ø 180 mm Highlight Element 1800W
- Child lock
- Hot surface indicator
- Key Lock
- Smart pause (with slider)

OPTIONAL FEATURES

- Slider touch control
- Ø 145 mm Oval Highlight Element 1000W/1800W
- Ø 180 mm Dual Highlight Element 700W/1700W
- Timer
- Bevelled edge glass

VFTC.03

STANDARD FEATURES

- 78 cm ceramic hob
- Front touch control
- 2 Ø 145 mm Highlight Element 1200W
- Child lock
- Hot surface indicator
- Key Lock

OPTIONAL FEATURES

- Ø 145 mm Oval Highlight Element 1000W/1800W
- Ø 210 mm Highlight Element 2300W

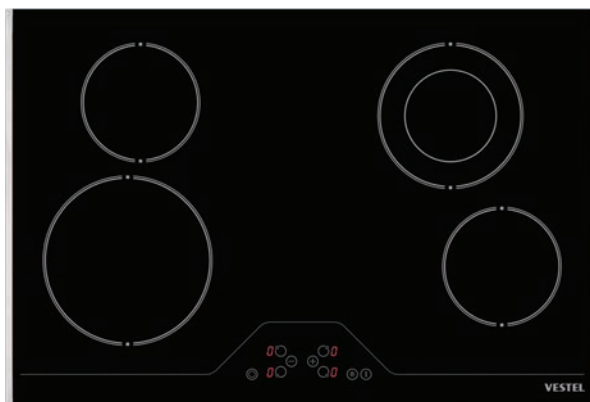
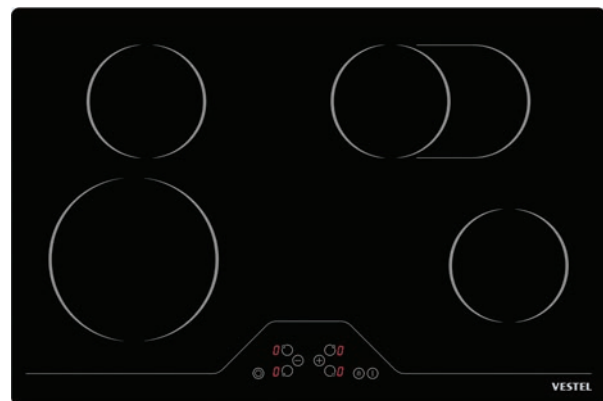

VFTC.13

STANDARD FEATURES

- 78 cm ceramic hob
- Front touch control
- 2 Ø 145 mm Highlight Element 1200W
- Child Lock
- Hot surface indicator
- Key lock

OPTIONAL FEATURES

- 1 Ø 210 mm Highlight Element 2300W
- 1 Ø 180mm Dual Highlight Element 700W/1700W
- Two side inox frame

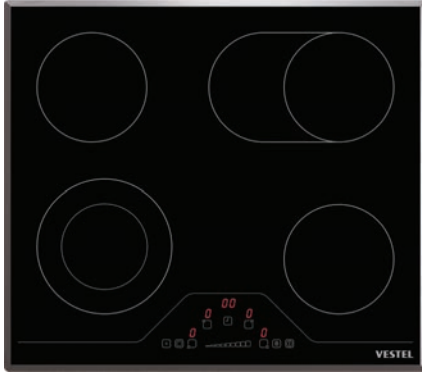

VFTC.04

STANDARD FEATURES

- 60 cm ceramic hob
- 2 Ø 145 mm Highlight Element 1200W
- Child lock
- Hot surface indicator
- Key Lock
- Smart pause (with slider)

OPTIONAL FEATURES

- Slider touch control
- Ø 180 mm Dual Highlight Element 700W/1700W
- Ø 145 mm Oval Highlight Element 1000W/1800W
- Timer
- Bevelled edge glass

VFTC.06

STANDARD FEATURES

- 60 cm ceramic hob
- 2 Ø 145 mm Highlight Element 1200W 2
- Ø 180 mm Highlight Element 1800W
- Child Lock
- Hot surface indicator
- Slim design ceran glass serigraphy
- Key Lock
- Smart pause (with slider)

OPTIONAL FEATURES

- Slider touch control
- Timer
- Full inox frame

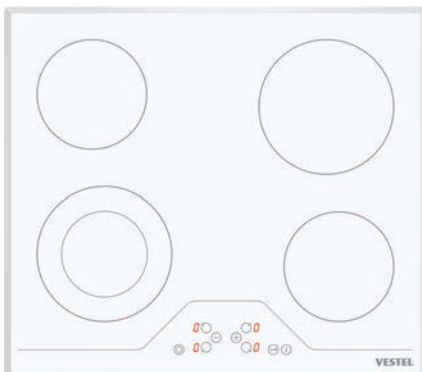
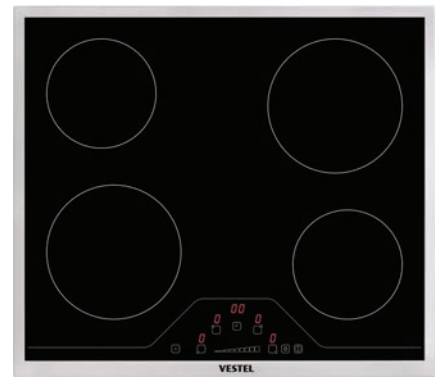

VFTC.08

STANDARD FEATURES

- 60 cm ceramic hob
- Front touch control
- 2 Ø 145 mm Highlight Element 1200W
- Ø 180 mm Highlight Element 1800W
- Child lock
- Hot surface indicator
- Key Lock

OPTIONAL FEATURES

- Ø 180 mm Dual Highlight Element 700W/1700W
- Bevelled edge glass
- White ceramic glass
- Timer

VITROCERAMIC HOBS



VFTC.10

STANDARD FEATURES

60 cm ceramic hob
Front touch control
Ø 145 mm Highlight Element
1200W Ø 180 mm Highlight
Element 1800W
Child lock
Hot surface indicator
Key Lock

OPTIONAL FEATURES

Ø 290 mm Triple Highlight
Element 1050W/1950W/2700W
Two side inox frame
Front and back side bevelled edge
glass

VFTC.11

STANDARD FEATURES

60 cm ceramic hob
Front touch control
Ø 145 mm Highlight Element
1200W Ø 180 mm Highlight
Element 1800W
Child lock
Hot surface indicator
Key Lock

OPTIONAL FEATURES

Ø 290 mm Dual Highlight Element
1800W/2700W
Timer
Front side bevelled edge glass
Slider touch control

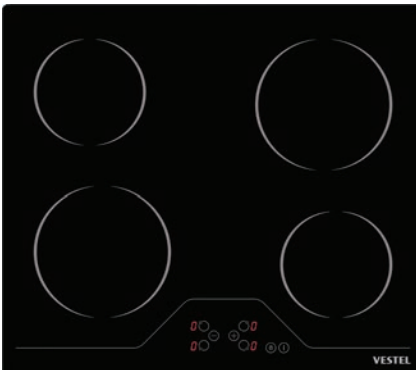
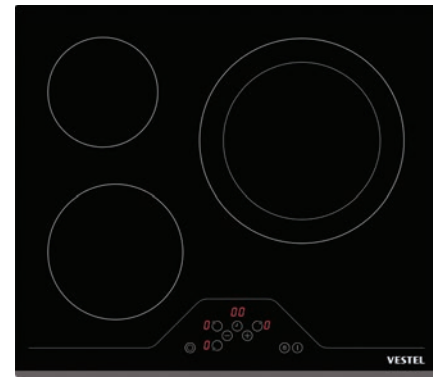

VFTC.12

FEATURES

60 cm ceramic hob
Front touch control
2 Ø 145 mm Highlight Element
1200W
2 Ø 180 mm Highlight Element
1800W
Child lock
Hot surface indicator
Key Lock

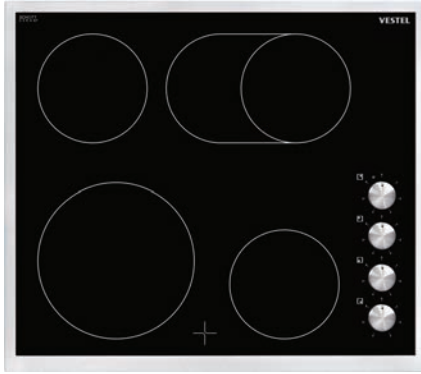

VKC.07

STANDARD FEATURES

- 60 cm ceramic hob
- Side knob control
- 2 Ø 145 mm Highlight Element 1200W
- Hot surface indicator light
- Slim design ceran glass serigraphy

OPTIONAL FEATURES

- Ø 145 mm Oval Highlight Element 1000W/1800W
- 210 mm highlight element 2300W
- Full inox frame
- Metal clad knob

VKC.02

STANDARD FEATURES

- 60 cm ceramic hob
- Side knob control
- 2 Ø 145 mm Highlight Element 1200W
- Hot surface indicator light

OPTIONAL FEATURES

- Ø 180 mm Dual Highlight Element 700W/1700W
- Ø 210 mm Highlight Element 2300W
- Front and back side bevelled edge glass
- Inox painted knobs

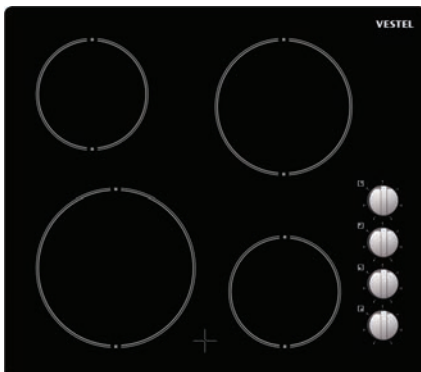
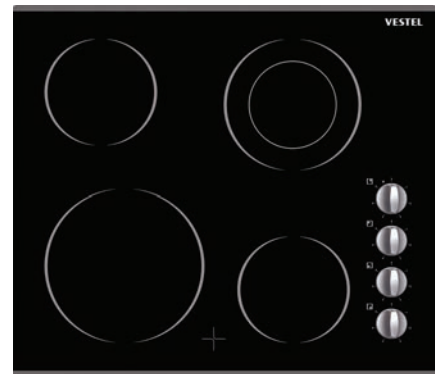

VKC.03

STANDARD FEATURES

- 60 cm ceramic hob
- Side knob control
- 2 Ø 145 mm Highlight Element 1200W Ø 180 mm Highlight Element 1800W
- Hot surface indicator light

OPTIONAL FEATURES

- Ø 210 mm Highlight Element 2300W
- Inox painted knobs

VITROCERAMIC HOBS



VKC.04

STANDARD FEATURES

- 60 cm ceramic hob
- Side knob control
- 2 Ø 145 mm Highlight Element 1200W
- Ø 180 mm Highlight Element 1800W
- Hot surface indicator light

OPTIONAL FEATURES

- Ø 180 mm Dual Highlight Element 700W/1700W
- Bevelled edge glass
- Inox painted knobs

VKC.05

STANDARD FEATURES

- 60 cm ceramic hob
- Side knob control
- 2 Ø 145 mm Highlight Element 1200W
- Hot surface indicator light

OPTIONAL FEATURES

- Ø145mm Oval Highlight Element 1000W/1800W
- Ø210 mm Highlight Element 2300W
- Front and back side bevelled edge glass
- Metal clad knobs
- White ceramic glass
- Two side inox frame

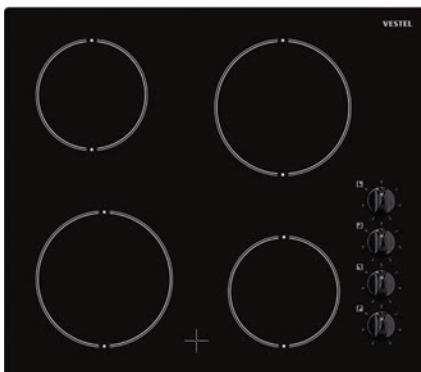
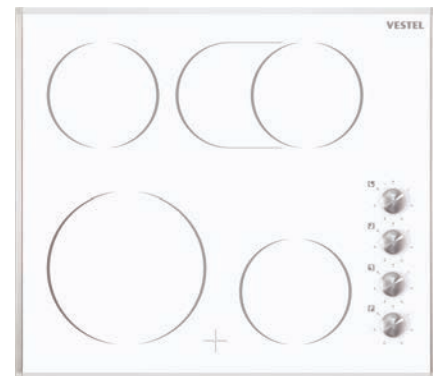

VKC.06

FEATURES

- 60 cm ceramic hob
- Side knob control
- 2 Ø 145 mm Highlight Element 1200W
- 2 Ø 180 mm Highlight Element 1800W
- Hot surface indicator light

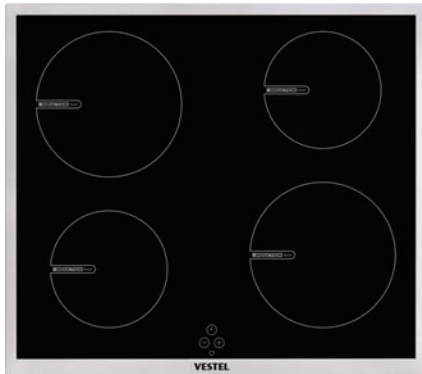

VICH.01

STANDARD FEATURES

- 60 cm induction ceramic hob
- Combination with oven
- Knob controlled from oven
- Booster function
- 2 Ø 160 mm 1400 W/Boost 1800 W induction element
- 2 Ø 200 mm 2100 W/Boost 2500 W induction element
- Pot detection
- Child lock
- Hot surface indicator

"OPTIONAL FEATURES

- Timer
- Slim design ceran glass serigraphy

VCH.02

STANDARD FEATURES

- 60 cm ceramic hob
- Combination with oven
- 2 Ø 145 mm Highlight Element 1200W
- Hot surface indicator light

OPTIONAL FEATURES

- Ø 180 mm Dual Highlight Element 700W/1700W
- Ø 145 mm Oval Highlight Element 1000W/1800W
- Bevelled edge glass

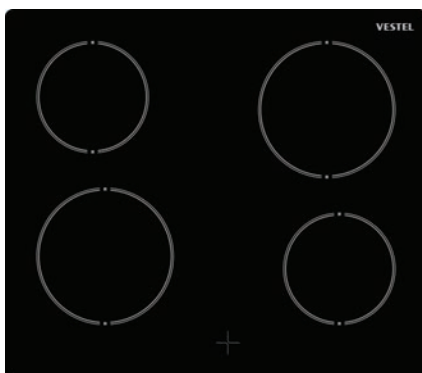
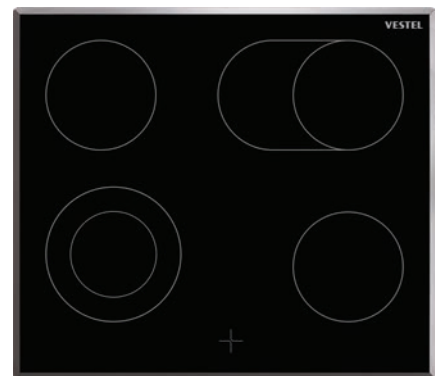

VCH.03

STANDARD FEATURES

- 60 cm ceramic hob
- Combination with oven
- 2 Ø 145 mm Highlight Element 1200W
- 2 Ø 180 mm Highlight Element 1800W
- Hot surface indicator light

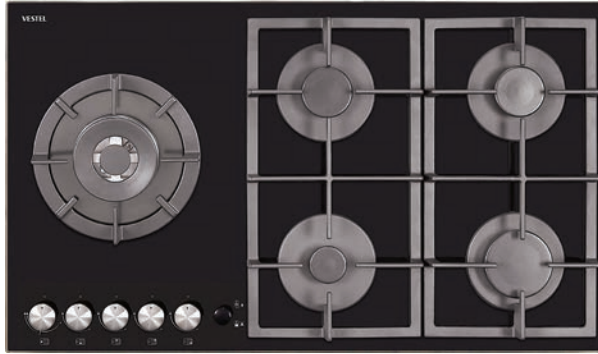

BGOGH.44

STANDARD FEATURES

- 90 cm gas on glass hob
- 5 gas burners
- High efficiency wok burner
- Front knob control
- Flame safety device
- Cast iron pan supports
- Cast iron burner caps
- Mat enamel burner pans

OPTIONAL FEATURES

- Dual work burner
- Main switch
- Metal cladded knobs
- One touch ignition

BGOGH.45

FEATURES

- 70 cm gas on glass hob
- 5 gas burners
- Semi flat burners
- Wok burner
- Front touch control
- Flame safety device
- Mat enamel burner pans
- Cast iron burner caps
- Cast iron pan supports
- Timer



BGOGH.46

STANDARD FEATURES

- 70 cm gas on glass hob
- 5 gas burners
- Semi flat burners
- Wok burner
- Front knob control
- Flame safety device
- Mat enamel burner pans
- One touch ignition
- Cast iron burner caps
- Cast iron pan supports

OPTIONAL FEATURES

- Metal cladded knobs





BGOGH.17

STANDARD FEATURES

- 70 cm gas on glass hob
- Plus X Design
- 5 gas burners
- Wok burner
- Front knob control
- Flame safety device

OPTIONAL FEATURES

- Mat enamel burner pans
- Mat enamel burner caps
- Cast iron pan supports
- Metal clad knobs
- One touch ignition

BGOGH.28

STANDARD FEATURES

- 70 cm gas on glass hob
- Plus X Design
- 5 gas burners
- Wok burner
- Front knob control
- Flame safety device

OPTIONAL FEATURES

- Mat enamel burner pans
- Mat enamel burner caps
- Cast iron pan supports
- Metal clad knobs
- One touch ignition



BGOGH.47

STANDARD FEATURES

- 70 cm gas on glass hob
- Plus X Design
- 5 gas burners
- Wok burner
- Front knob control
- Flame safety device
- Enamel burner pans
- Enamel burner caps
- Enamel pan supports

OPTIONAL FEATURES

- Metal clad knobs
- One touch ignition
- PlusX design pan supports



BGOGH.29

STANDARD FEATURES

- 70 cm gas on glass hob
- Plus X Design
- 5 gas burners
- Wok burner
- Front knob control
- Flame safety device

OPTIONAL FEATURES

- White optical glass
- Inox burner pans
- Mat enamel burner caps
- Cast iron pan supports (line design)
- Metal clad knobs
- One touch ignition

BGOGH.31

STANDARD FEATURES

- 70 cm gas on glass hob
- Plus X Design
- 5 gas burners
- Wok burner
- Front knob control
- Flame safety device

OPTIONAL FEATURES

- Mat enamel burner pans
- Cast iron burner caps
- Cast iron pan supports (deluxe design)
- Metal clad knobs
- One touch ignition



BGOGH.48

STANDARD FEATURES

- 60 cm gas on glass hob
- 4 gas burners
- Semi flat burners
- Side knob control
- Flame safety device
- Mat enamel burner pans
- One touch ignition
- Cast iron burner caps
- Cast iron pan supports

OPTIONAL FEATURES

- Metal clad knobs
- Wok burner



BGOGH.20

STANDARD FEATURES

- 60 cm gas on glass hob
- Plus X Design
- 4 gas burners
- Front knob control
- Flame safety device

OPTIONAL FEATURES

- Mat enamel burner pans
- Mat enamel burner caps
- Cast iron pan supports (line design)
- Metal clad knobs
- One touch ignition

BGOGH.32

STANDARD FEATURES

- 60 cm gas on glass hob
- Plus X Design
- 4 gas burners
- Front knob control
- Flame safety device

OPTIONAL FEATURES

- Wok burner
- Mat enamel burner pans
- Mat enamel burner caps
- Cast iron pan supports (line design)
- Metal clad knobs
- One touch ignition

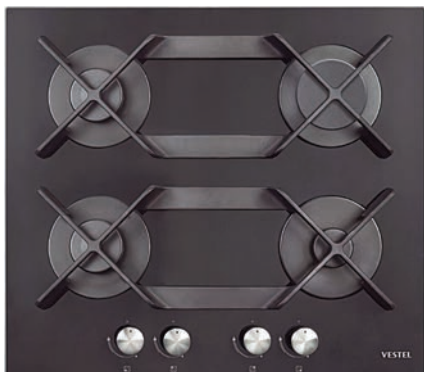

BGOGH.19

STANDARD FEATURES

- 60 cm gas on glass hob
- Plus X Design
- 4 gas burners
- Front knob control
- Flame safety device

OPTIONAL FEATURES

- Mat enamel burner pans
- Cast iron burner caps
- Cast iron pan supports
- Metal clad knobs
- One touch ignition



BGOGH.50

STANDARD FEATURES

- 60 cm gas on glass hob
- Plus X Design
- 4 gas burners
- Wok burner
- Front knob control
- Flame safety device
- Enamel burner pans
- Enamel burner caps
- Enamel pan supports

OPTIONAL FEATURES

- White optical glass
- Metal clad knobs
- One touch ignition
- PlusX design pan supports

BGOGH.34

STANDARD FEATURES

- 60 cm gas on glass hob
- Plus X Design
- 4 gas burners
- Front knob control
- Flame safety device

OPTIONAL FEATURES

- Mirror glass
- Wok burner
- Inox burner pans
- Mat enamel burner caps
- Cast iron pan supports (deluxe design)
- Metal clad knobs
- One touch ignition



BGOGH.36

STANDARD FEATURES

- 60 cm gas on glass hob
- Plus X Design
- 4 gas burners
- Front knob control
- Flame safety device

OPTIONAL FEATURES

- White optical glass
- Inox burner pans
- Mat enamel burner caps
- Cast iron pan supports
- Metal clad knobs
- One touch ignition



BGOGH.18

STANDARD FEATURES

- 60 cm gas on glass hob
- Plus X Design
- Front knob control
- Flame safety device
- Enamel burner pans
- Enamel burner caps
- Enamel pan supports

OPTIONAL FEATURES

- Metal clad knobs
- One touch ignition
- 3 gas burners and 145 mm hotplate

BGOGH.21

STANDARD FEATURES

- 60 cm gas on glass hob
- Plus X Design
- 4 gas burners
- Front knob control
- Flame safety device

OPTIONAL FEATURES

- Mat enamel burner pans
- Mat enamel burner caps
- Cast iron pan supports
- Metal clad knobs
- One touch ignition

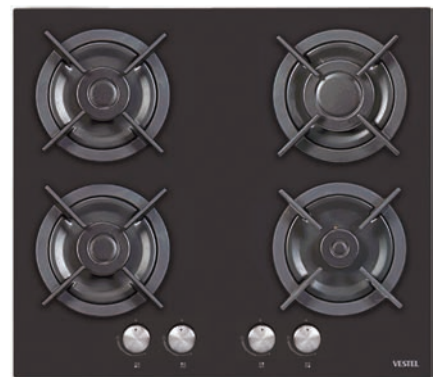

BGOGH.49

STANDARD FEATURES

- 60 cm gas on glass hob
- Plus X Design
- 4 gas burners
- Front knob control
- Flame safety device
- Enamel burner pans
- Enamel burner caps
- Enamel pan supports

OPTIONAL FEATURES

- Metal clad knobs
- One touch ignition
- PlusX design pan supports



BGOGH.07

STANDARD FEATURES

- 70 cm gas on glass hob
- 5 gas burners
- Front knob control
- Wok burner
- Flame safety device
- Enamel pan supports
- Enamel burner pans
- Enamel burner caps

OPTIONAL FEATURES

- Stainless steel frame
- One touch ignition
- Metal clad knobs

BGOGH.09

STANDARD FEATURES

- 60 cm gas on glass hob
- 4 gas burners
- Front knob control
- Black glass
- Enamel burner pans
- Enamel pan supports
- Enamel burner caps

OPTIONAL FEATURES

- One touch ignition
- Flame safety device
- Inox frame



BGOGH.37

STANDARD FEATURES

- 60 cm gas on glass hob
- 4 gas burners
- Front knob control
- Flame safety device

OPTIONAL FEATURES

- Inox burner pans
- One touch ignition
- Inox frame
- Cast iron pan supports
- Cast iron burner caps



BGOGH.24

STANDARD FEATURES

- 60 cm gas on glass and induction hob
- Pure Design
- Side knob control and Side touch control
- 2 gas burners
- Enamel burner pans, pan supports and burner caps
- Flame safety device
- Booster function
- Ø 160 mm 1400 W/Boost 1800 W induction element

- Ø 200 mm 2100 W/Boost 2500 W induction element
- Pot detection
- Automatic heat up
- Child lock
- Hot surface indicator
- Key Lock
- Timer

OPTIONAL FEATURES

- Metal clad knobs
- One touch ignition

BGOGH.38

STANDARD FEATURES

- 60 cm gas on glass and induction hob
- Pure design
- Side knob control and side touch control
- 2 gas burners - Flame safety device Ø 160 mm 1400 W/Boost 1800 W induction element
- Ø 200 mm 2100 W/Boost 2500 W induction element
- Pot detection
- Child lock

- Hot surface indicator
- Touch control interface for induction zones
- Key Lock
- Timer

OPTIONAL FEATURES

- Mat enamel burner pans and caps
- Cast iron pan supports
- Metal clad knobs
- Full inox frame
- One touch ignition

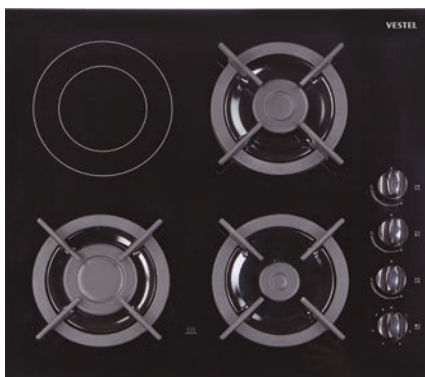

BGOGH.23

STANDARD FEATURES

- Pure Design
- 60 cm gas on glass and vitroceramic hob
- Side knob control
- 3 gas burners
- Enamel burner pans
- Flame safety device
- Hot surface indicator

OPTIONAL FEATURES

- Cast iron pan supports
- Cast iron burner caps
- Ø 180 mm Dual Highlight Element 700W/1700W
- One touch ignition



BGOGH.39

STANDARD FEATURES

- 60 cm gas on glass and vitroceramic hob
- Pure design
- Side knob control
- 3 gas burners
- Flame safety device
- Ø 180 mm Highlight Element
- 1800W Hot surface indicator

OPTIONAL FEATURES

- Mat enamel burner pans and caps
- Cast iron pan supports
- Metal clad knobs
- Full inox frame
- One touch ignition

BGOGH.25

STANDARD FEATURES

- 60cm gas on glass and vitroceramic hob
- Pure design
- Side knob control
- 2 gas burners
- Flame safety device
- Ø 145 mm Highlight Element
- 1200W Ø 180 mm Highlight Element
- 1800W Hot surface indicator

OPTIONAL FEATURES

- Mat enamel burner pans
- Mat enamel burner caps
- Cast iron pan supports
- Metal clad knobs
- One touch ignition

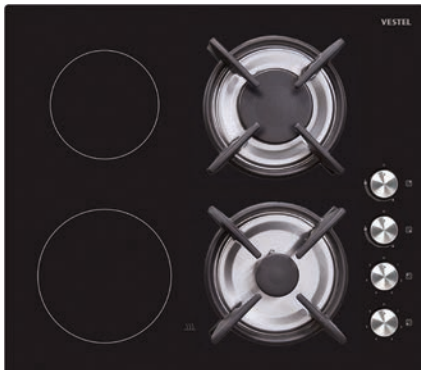
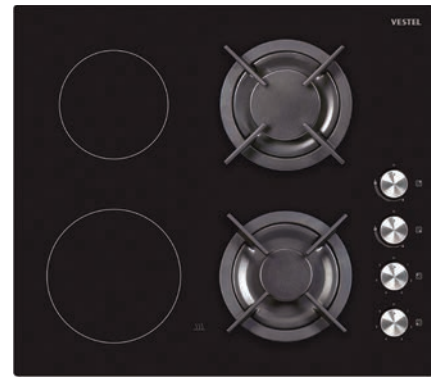

BGOGH.51

STANDARD FEATURES

- 60cm gas on glass and vitroceramic hob
- Pure design
- Side knob control
- 2 gas burners
- Flame safety device
- Ø 145 mm Highlight Element 1200W
- Ø 180 mm Highlight Element 1800W
- Hot surface indicator

OPTIONAL FEATURES

- Inox burner pans
- Cast iron burner caps
- Cast iron pan supports
- Metal clad knobs
- One touch ignition



BGOGH.43

STANDARD FEATURES

- 60 cm gas on glass hob
- Division design
- 4 gas burners
- Front knob control
- Flame safety device
- Cast iron pan supports
- Enamel burner caps
- Enamel burner caps

OPTIONAL FEATURES

- Metal clad knobs
- One touch ignition

BGOGH.41

STANDARD FEATURES

- 60 cm gas on glass hob
- 3 gas burners
- Wok burner
- Side knob control
- Flame safety device

OPTIONAL FEATURES

- Mat enamel burner pans
- Mat enamel burner caps
- Mat enamel pan supports
- One touch ignition



BGOGH.05

STANDARD FEATURES

- 60 cm gas on glass hob
- 4 gas burners
- Side knob control
- Black Glass
- Enamel burner pans
- Flame safety device

OPTIONAL FEATURES

- Wok burner
- Cast iron burner caps
- Cast iron pan supports
- One touch ignition



BGOGH.11

STANDARD FEATURES

- 60 cm gas on glass hob 4 gas burners
- Side knob control
- Enamel burner caps
- Enamel pan supports
- Flame safety device

OPTIONAL FEATURES

- Inox burner pans
- Mink colored optical glass
- Metal clad knobs
- One touch ignition

BGOGH.26

STANDARD FEATURES

- 60 cm gas on glass hob
- 4 gas burners
- Side knob control
- Flame safety device

OPTIONAL FEATURES

- Mat enamel burner caps
- Mat enamel pan supports
- Mat enamel burner pans
- White optical glass
- One touch ignition



BGOGH.13

STANDARD FEATURES

- 60 cm gas on glass hob
- 4 gas burners
- Side knob control

OPTIONAL FEATURES

- Wok burner
- Mirror glass
- Inox burner pans
- Cast iron pan supports
- Cast iron burner caps
- One touch ignition
- Flame safety device
- Metal clad knobs



BGOGH.16

STANDARD FEATURES

- 60 cm gas on glass hob
- 4 gas burners
- Side knob control Black glass
- Enamel pan supports
- Enamel burner caps
- Inox burner pans

OPTIONAL FEATURES

- One touch ignition
- Flame safety device
- Metal clad knobs
- Inox burner pans

BGOGH.01

STANDARD FEATURES

- 60 cm gas on glass hob
- 4 gas burners
- Side knob control
- Enamel burner caps
- Enamel pan supports
- Enamel burner pans
- Flame safety device

OPTIONAL FEATURES

- Metal clad knobs
- One touch ignition



BGOGH.42

STANDARD FEATURES

- 60 cm gas on glass hob
- 4 gas burners
- Side knob control
- Enamel burner caps
- Enamel pan supports
- Flame safety device

OPTIONAL FEATURES

- Inox burner pans
- White optical glass
- Metal clad knobs
- One touch ignition



BGOGH.27 Rustic

STANDARD FEATURES

- 60 cm gas on glass hob
- 4 gas burners
- Side knob control
- Flame safety device
- Enamel burner caps
- Enamel pan supports
- Enamel burner pans

OPTIONAL FEATURES

- Type-C Rustic design black optical glass
- One touch ignition
- Flame safety device
- Special rustic knobs

BGOGH.12 Rustic

STANDARD FEATURES

- 60 cm gas on glass hob
- 4 gas burners
- Side knob control
- Flame safety device
- Enamel burner caps
- Enamel pan supports
- Enamel burner pans

OPTIONAL FEATURES

- Type-C Rustic design cream optical glass
- One touch ignition
- Flame safety device
- Special rustic knobs



BGOGH.15 Rustic

STANDARD FEATURES

- 60 cm gas on glass hob
- 4 gas burners
- Side knob control
- Flame safety device
- Enamel burner caps
- Enamel pan supports
- Enamel burner pans

OPTIONAL FEATURES

- Type-B Rustic design white optical glass
- One touch ignition
- Flame safety device
- Special rustic knobs



BGH.44

STANDARD FEATURES

70 cm gas hob Plus X Design
5 gas burners
Wok burner
Front knob control Flame safety device

OPTIONAL FEATURES

Stainless steel
Glass control panel
Cast iron burner caps
Cast iron pan supports
Metal clad knobs
One touch ignition

BGH.45

STANDARD FEATURES

70 cm gas hob
Plus X Design
5 gas burners
Wok burner
Front knob control
Enamel pan supports
Enamel burner pans
Flame safety device

OPTIONAL FEATURES

Stainless steel
Inox painted knobs
One touch ignition



BGH.46

STANDARD FEATURES

70 cm gas hob
Plus X Design
5 gas burners
Wok burner
Front knob control
Flame safety device

OPTIONAL FEATURES

Stainless steel
Cast iron burner caps
Cast iron pan supports
Inox painted knobs
One touch ignition

GAS HOBS



BGH.47

STANDARD FEATURES

- 60 cm gas hob
- Plus X Design
- 4 gas burners
- Front knob control
- Flame safety device

OPTIONAL FEATURES

- Stainless steel
- Wok burner
- Mat enamel burner caps
- Cast iron pan supports
- Glass control panel
- Metal clad knobs
- One touch ignition

BGH.57

STANDARD FEATURES

- 60 cm gas hob
- Plus X Design
- 4 gas burners
- Front knob control
- Enamel pan supports
- Enamel burner pans
- Flame safety device

OPTIONAL FEATURES

- Metal clad knobs
- Black enamel hob
- One touch ignition



BGH.48

STANDARD FEATURES

- 60 cm gas hob
- Plus X Design
- 4 gas burners
- Front knob control
- Flame safety device

OPTIONAL FEATURES

- Stainless steel
- Cast iron burner caps
- Cast iron pan supports
- Glass control panel
- Metal clad knobs
- One touch ignition



BGH.50

STANDARD FEATURES

- 60 cm gas hob
- Plus X Design
- 4 gas burners
- Front knob control
- Enamel pan supports
- Enamel burner pans
- Flame safety device

OPTIONAL FEATURES

- Metal clad knobs
- One touch ignition

BGH.51

STANDARD FEATURES

- 60 cm gas hob
- Plus X Design
- 4 gas burners
- Front knob control
- Enamel pan supports
- Enamel burner caps
- Flame safety device

OPTIONAL FEATURES

- Stainless steel
- Inox painted knobs
- One touch ignition



BGH.52

STANDARD FEATURES

- 60 cm gas hob
- Division design
- 4 gas burners
- Front knob control
- Flame safety device
- Cast iron pan supports
- Mat enamel burner caps
- Stainless steel hob

OPTIONAL FEATURES

- Metal clad knobs
- One touch ignition

GAS HOBS



BGH.56

STANDARD FEATURES

- 70 cm gas hob
- 5 gas burners
- Front knob control
- Wok burner
- Flame Safety device

OPTIONAL FEATURES

- Stainless steel hob
- Cast iron pan supports
- Cast iron burner caps
- One touch ignition

BGH.38

STANDARD FEATURES

- 70 cm gas hob
- 5 gas burners
- Front knob control
- Enamel pan supports
- Enamel burner caps

OPTIONAL FEATURES

- Stainless steel hob
- Button ignition
- Flame safety device



BGH.58

STANDARD FEATURES

- 70cm gas hob
- 5 gas burners
- Wok burner
- Flame safety device
- Front knob control

OPTIONAL FEATURES

- Black enamel hob
- Metal cladded knobs
- Cast iron pan supports
- Cast iron burner caps
- One touch ignition



BGH.25

STANDARD FEATURES

- 60 cm gas hob
- 4 gas burners
- Front knob control
- Flame safety device

OPTIONAL FEATURES

- Stainless steel hob
- Wok burner
- Cast iron burner caps
- Cast iron pan supports
- One touch ignition

BGH.55

STANDARD FEATURES

- 60 cm gas hob
- 4 gas burners
- Front knob control
- Enamel pan supports
- Enamel burner caps
- Flame safety device

OPTIONAL FEATURES

- Stainless steel hob
- Wok burner
- Cast iron burner caps
- Cast iron pan supports
- One touch ignition
- Flame safety device



BGH.34

STANDARD FEATURES

- 60 cm gas hob
- 4 gas burners
- Front knob control
- Enamel pan supports
- Enamel burner caps

OPTIONAL FEATURES

- Black enamel hob
- One touch ignition
- Flame safety device
- Metal clad knobs

GAS HOBS



BGH.29

STANDARD FEATURES

- 60 cm gas hob
- Surface design
- 4 gas burners
- Side knob control
- Enamel pan supports
- Enamel burner caps
- Flame safety device

OPTIONAL FEATURES

- Stainless steel hob
- One touch ignition
- Metal clad knobs

BGH.02

STANDARD FEATURES

- 60 cm gas hob
- Surface design
- 3 gas burners
- Ø 180mm hotplate
- Side knob control
- Flame safety device

OPTIONAL FEATURES

- Stainless steel hob
- One touch ignition
- Cast iron pan supports
- Cast iron burner caps
- Metal clad knobs



BGH.03

STANDARD FEATURES

- 60 cm mixed hob
- 3 gas burners
- 180 mm hotplate
- Side knob control
- Enamel pan supports
- Enamel burner caps
- Flame safety device

OPTIONAL FEATURES

- Stainless steel hob
- Electric hotplate
- One touch ignition
- Metal clad knobs



BGH.05

STANDARD FEATURES

- 60 cm gas hob
- Surface design
- 4 gas burners
- Side knob control
- Enamel pan supports
- Enamel burner caps
- Flame safety device
- White enamel hob

OPTIONAL FEATURES

- One touch ignition

BGH.07

STANDARD FEATURES

- 60 cm gas hob
- Surface design
- 3 gas burners
- Ø 180mm hotplate
- Side knob control
- Enamel pan supports
- Enamel burner caps
- Flame safety device
- White enamel hob

OPTIONAL FEATURES

- One touch ignition



BGH.08

STANDARD FEATURES

- 60 cm gas hob
- White enamel hob
- 4 gas burners
- Side knob control
- Enamel pan supports
- Enamel burner caps
- Flame safety device

OPTIONAL FEATURES

- One touch ignition

GAS HOBS



BGH.09

STANDARD FEATURES

- 60 cm gas hob
- Surface design
- 4 gas burners
- Side knob control
- Flame safety device

OPTIONAL FEATURES

- Stainless steel hob
- One touch ignition
- Wok burner
- Cast iron pan supports
- Cast iron burner caps

BGH.10

STANDARD FEATURES

- 60 cm gas hob
- Surface design
- 3 gas burners
- Ø 180mm hotplate
- Side knob control
- Flame safety device

OPTIONAL FEATURES

- One touch ignition
- Black enamel hob
- Cast iron pan supports
- Cast iron burner caps
- Mat black knobs



BGH.01

STANDARD FEATURES

- 60 cm gas hob
- Surface design
- 4 gas burners
- Side knob control
- Flame safety device

OPTIONAL FEATURES

- Stainless steel hob
- One touch ignition
- Metal clad knobs
- Cast iron pan supports
- Cast iron burner caps



BGH.43

STANDARD FEATURES

- 60 cm gas hob
- Extenda design
- 4 gas burners
- Side knob control
- Flame safety device

OPTIONAL FEATURES

- Stainless steel
- Cast iron burner caps
- Cast iron pan supports
- One touch ignition
- Metal clad knobs

BGH.53

STANDARD FEATURES

- 60 cm mixed hob
- Smootline design
- 3 gas burners
- Ø 180 mm hotplate
- Side knob control
- Enamel pan supports
- Enamel burner camps
- Flame safety device

OPTIONAL FEATURES

- One touch ignition



BGH.54

STANDARD FEATURES

- 60 cm gas hob
- Smootline design
- 4 gas burners
- Side knob control
- Enamel pan supports
- Enamel burner caps
- Flame safety device

OPTIONAL FEATURES

- Black enamelled hob
- Button ignition

GAS HOBS



BGH.40

STANDARD FEATURES

Smoothline design
60 cm gas hob
4 gas burners
Side Knob control
Enamel pan supports
Enamel burner caps
Flame safety device

OPTIONAL FEATURES

Stainless steel hob
Button ignition
Metal clad knobs

BGH.39

STANDARD FEATURES

Smoothline design
60 cm gas hob
4 gas burners
Side Knob control
Enamel pan supports
Enamel burner caps
White enamel hob

OPTIONAL FEATURES

One touch ignition
Flame safety device



BGH.41

STANDARD FEATURES

Smoothline design
60 cm gas hob
4 gas burners
Side Knob control
Enamel pan supports
Enamel burner caps
Flame safety device

OPTIONAL FEATURES

TDF enamel hob
One touch ignition
Black knobs



BGH.30 Rustic

STANDARD FEATURES

- 60 cm gas hob
- Surface design
- 4 gas burners
- Side knob control
- Flame safety device
- Enamel pan supports
- Enamel burner caps

OPTIONAL FEATURES

- Type-A Rustic design
- Special rustic knobs
- One touch ignition
- Black enamel hob

BGH.31 Rustic

STANDARD FEATURES

- 60 cm gas hob
- Surface design
- 4 gas burners
- Side knob control
- Flame safety device
- Enamel pan supports
- Enamel burner caps
- White enamel hob

OPTIONAL FEATURES

- Type-A Rustic design
- One touch ignition



BGH.28 Rustic

STANDARD FEATURES

- 60 cm gas hob
- Surface design
- 4 gas burners
- Side knob control
- Flame safety device

OPTIONAL FEATURES

- Type-B Rustic design
- Special rustic knobs
- One touch ignition
- Black enamel hob
- Cast iron pan supports
- Cast iron burner caps

GAS HOBS



BEH.01

STANDARD FEATURES

60 cm electric hob
Surface design
4 solid hotplates
(2x145mm)+(2x180mm)
Side knob control

OPTIONAL FEATURES

Stainless steel hob
Black knobs

BEH.02

STANDARD FEATURES

60 cm electric hob
Surface design
4 solid hotplates
(2x145mm)+(2x180mm)
Side knob control

OPTIONAL FEATURES

Black enamel hob
Inox painted knobs



BEH.05

STANDARD FEATURES

60cm electric hob
Surface design
4 solid hotplates
(2x145mm)+(2x180mm)
Side knob control

OPTIONAL FEATURES

Stainless steel hob



BCH.01

FEATURES

60 cm electrical combi hob
White enamel hob
Combination with oven
4 solid hotplates
(2x145mm) + (2x180mm)

BCH.02

FEATURES

60 cm electrical combi hob
Black enamel hob
Combination with oven
4 solid hotplates
(2x145mm) + (2x180mm)



BCH.03

STANDARD FEATURES

60 cm electrical combi hob
Combination with oven
4 solid hotplates
(2x145mm) + (2x180mm)

OPTIONAL FEATURES

1 Rapid hotplate
Stainless steel hob

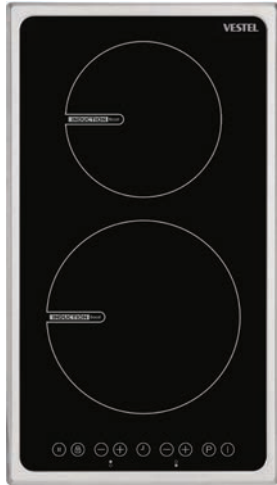

DIHS2.01 Domino Series 2

STANDARD FEATURES

- 30 cm ceramic hob
- Domino series 2 design
- Front touch control
- Booster function
- Ø 160 mm 1400 W/Boost 1800 W induction element
- Ø 200 mm 2100 W/Boost 2500 W induction element
- Child lock
- Automatic heat up

- Child lock
- Hot surface indicator

OPTIONAL FEATURES

- Timer

DVHS2.02 Domino Series 2

STANDARD FEATURES

- 30 cm ceramic hob
- Domino series 2 design
- Front touch control
- Ø 145 mm Highlight Element
- 1200W 700W/1700W
- Hot surface indicator

OPTIONAL FEATURES

- Ø 180 mm Dual Highlight Element
- Timer



DVHS2.01 Domino Series 2

STANDARD FEATURES

- 30 cm ceramic hob
- Domino series 2 design
- Front knob control
- Ø 145 mm Highlight Element
- 1200W 700W/1700W
- Hot surface indicator light

OPTIONAL FEATURES

- Ø 180 mm Dual Highlight Element
- Metal clad knobs



DEHS2.02 Domino Series 2

STANDARD FEATURES

30 cm electric hob
 Domino series 2 design
 Front knob control
 Ø 145 mm solid hotplate
 Ø 180 mm rapid hotplate

OPTIONAL FEATURES

Metal clad knobs
 Mechanical timer
 1 rapid zone

DEHS2.01 Domino Series 2

STANDARD FEATURES

30 cm electric hob
 Domino series 2 design
 Front knob control
 Ø 145 mm solid hotplate
 Ø 180 mm rapid hotplate

OPTIONAL FEATURES

Metal clad knobs
 1 rapid zone



DGHS2.05 Domino Series 2

STANDARD FEATURES

30 cm gas hob
 Domino series 2 design
 Stainless steel hob
 Wok burner
 Flame safety device
 Metal knob

OPTIONAL FEATURES

Mat enamel pan support
 Mat enamel burner pan
 One touch ignition



DGHS2.04 Domino Series 2

STANDARD FEATURES

- 30 cm gas hob
- Domino series 2 design
- Stainless steel hob
- 2 gas burners
- Flame safety device

OPTIONAL FEATURES

- Cast iron pan supports
- Cast iron burner caps
- One touch ignition
- Metal clad knobs

DGHS2.01 Domino Series 2

STANDARD FEATURES

- 30 cm gas on glass hob
- Domino series 2 design
- Black glass
- 2 gas burners
- Flame safety device

OPTIONAL FEATURES

- Cast iron pan supports
- Cast iron burner caps
- Inox burner pans
- One touch ignition
- Metal clad knobs



DGHS2.02 Domino Series 2

STANDARD FEATURES

- 30 cm gas on glass hob
- Domino series 2 design
- Black glass
- Wok burner
- Flame safety device

OPTIONAL FEATURES

- Metal enamel burner pan
- Cast iron pan support
- Cast iron burner caps
- One touch ignition
- Metal clad knobs



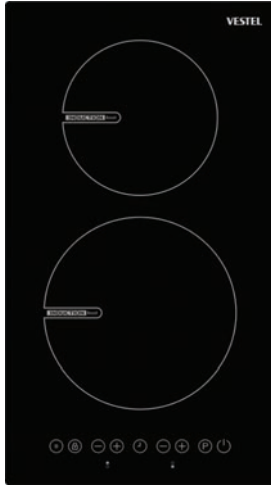

DIHS1.01 Domino Series 1

STANDARD FEATURES

- 30 cm induction hob
- Front touch control
- Booster function
- Ø 160 mm 1400 W/ Boost 1800 W induction element
- Ø 200 mm 2100 W/ Boost 2500 W induction element
- Pot detection
- Automatic heat up
- Child lock
- Hot surface indicator

OPTIONAL FEATURES

- Timer

DVHS1.03 Domino Series 1

STANDARD FEATURES

- 30 cm ceramic hob
- Front touch control
- Ø 145 mm Highlight Element 1200W 700W/1700W
- Child lock
- Hot surface indicator
- Key lock
- Smart Pause

OPTIONAL FEATURES

- Ø 180 mm Dual Highlight Element

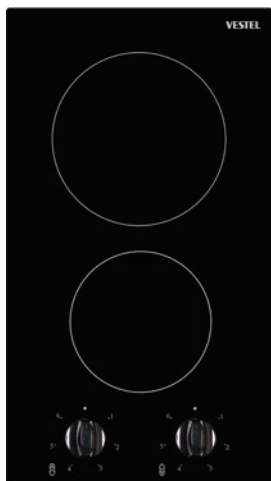
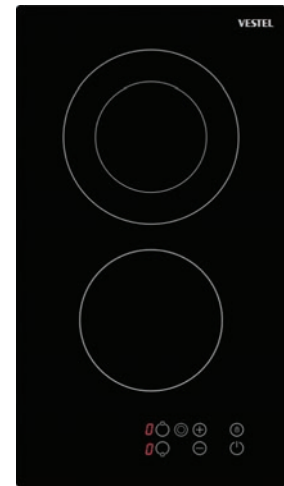

DVHS1.01 Domino Series 1

FEATURES

- 30 cm ceramic hob
- Front knob control
- Ø 145 mm Highlight Element 1200W Ø 180 mm Highlight Element 1800W Hot surface indicator light



DGHS1.03 Domino Series 1

STANDARD FEATURES

30 cm gas on glass hob
Domino series 1 design
Black glass
2 gas burners
Flame safety device

OPTIONAL FEATURES

Cast iron pan supports
Cast iron burner caps
Inox burner pans
One touch ignition

DGHS1.04 Domino Series 1

STANDARD FEATURES

30 cm gas on glass hob
Domino series 1 design
Black glass
Wok burner
Flame safety device

OPTIONAL FEATURES

Mat enamel pan support
Mat enamel burner pan
Inox burner pan
One touch ignition



DGHS1.01 Domino Series 1

STANDARD FEATURES

30 cm gas on glass hob
Domino series 1 design
Black glass
2 gas burners
Enamel pan supports
Enamel burner caps
Enamel burner pans
Flame safety device

OPTIONAL FEATURES

One touch ignition

TABLE TOP HOB SPECIFICATIONS

BUILT-IN / TABLE-TOP HOB SPECIFICATION SHEET	TT Gas / Comnined / Gas Securit Hobs				TT Electric Hobs			
	60 CM	60 CM	60 CM	60 CM	60 CM	60 CM	60 CM	
	Flat / Surface	Smoothline	New Gen.	PlusX	Flat / Surface	Smoothline	New Gen.	
Available Colours								
White		Standard	Standard	Standard	Optional	Standard	Standard	Standard
Brown		Optional	Optional	-	Optional	Optional	Optional	-
Terre de France		Optional	Optional	-	Optional	Optional	Optional	-
Black		Optional	Optional	Optional	Standard	Optional	Optional	Optional
Dark Green		Optional	Optional	-	Optional	Optional	Optional	-
Stainless Steel		Optional	Optional	Optional	Optional	Optional	Optional	Optional
Product Dimensions								
Height (max., varies from model to model)	mm	95,5 - 104,5	95,5 - 104,5	95,5 - 104,5	104	56,5 - 104,5	56,5 - 104,5	56,5 - 104,5
Width	mm	585	585	580	597	585	585	585
Depth (max., do not include gas connection detail)	mm	540	540	540	526	540	540	540
Hob Features								
Hob		Enamel / Stainless Steel	Enamel / Stainless Steel	Enamel / Stainless Steel	Securit	Enamel / Stainless Steel	Enamel / Stainless Steel	Enamel / Stainless Steel
Rapid Gas Burner Ø10cm	W	3000	3000	3000	3000	-	-	-
Semi-rapid Gas Burner Ø7.5cm	W	1750	1750	1750	1750	-	-	-
Auxiliary Gas Burner Ø5.5cm	W	1000	1000	1000	1000	-	-	-
Wok (Triple Flame) Gas Burner Mono Ø14cm	W	3600	3600	3600	3600	-	-	-
Wok (Triple Flame) Gas Burner Dual Ø14cm	W	-	-	-	-	-	-	-
Wok (Triple Flame) Gas Burner Ø11cm	W	-	-	-	-	-	-	-
Ø 145 mm Hotplate	W	-	1000	-	1000	1000	1000	1000
Ø 180 mm Hotplate	W	1500	-	1500	-	1500	1500	1500
Ø 145 mm Rapid Hotplate	W	-	1500	-	-	1500	1500	1500
Ø 180 mm Rapid Hotplate	W	2000	-	2000	-	2000	2000	2000
Hotplate Operation Indicator Light		Standard	Standard	Standard	Standard	Standard	Standard	Standard
Side Knob Control		Standard	Standard	Standard	-	Standard	Standard	Standard
Front Knob Control		-	-	-	Standard	-	-	-
Bevelled Edges		-	-	-	-	-	-	-
Logo		Standard	Standard	Standard	Standard	Standard	Standard	Standard
Special Decoration on Glass		-	-	-	-	-	-	-
Stainless Steel Burner Pan		-	-	-	-	-	-	-
Table Top Installation (not built-in)		Standard	Standard	Standard	Standard	Standard	Standard	Standard
Glass Lid		Optional	Optional	Optional	-	Optional	Optional	Optional
Burner Safety Valves		Standard	Standard	Standard	Standard	-	-	-
Button Ignition		Optional	Optional	Optional	Optional	-	-	-
One-touch-Ignition through knobs		Optional	Optional	Optional	Optional	-	-	-
Enamel Pan Supports		Standard	Standard	Standard	Standard	-	-	-
Cast Iron Pan Supports		Optional	Optional	Optional	Optional	-	-	-
Cast Iron Burner Caps		Optional	Optional	Optional	Optional	-	-	-
Coffee Adaptor		Optional	Optional	Optional	Optional	-	-	-
Wok Adaptor		Optional	Optional	Optional	Optional	-	-	-
Gas Conversion Kit		Standard	Standard	Standard	Standard	-	-	-
Others								
Total Gas Power (Depends on Model) Maximum	kW	8,1	8,1	8,1	8,1	-	-	-
Total Electric Power (Depends on Model) Maximum	kW	-	-	-	1	6	6	6
Voltage	V	230V~	230V~	230V~	230V~	230 / 400V 3N~	230 / 400V 3N~	230 / 400V 3N~
RoHS Compliance		Standard	Standard	Standard	Standard	Standard	Standard	Standard
CE Compliance		Standard	Standard	Standard	Standard	Standard	Standard	Standard
Carton Box Packaging		Standard	Standard	Standard	Standard	Standard	Standard	Standard
Packed Product Dimensions (WxDxH)	mm	643 x 645 x 132	643 x 645 x 132	x	x	643 x 645 x 132	643 x 645 x 132	x
Packed Product Dimensions (WxDxH) Box	mm	662 x 648 x 140	662 x 648 x 140	662 x 648 x 140	645 x 648 x 140	662 x 648 x 140	662 x 648 x 140	662 x 648 x 140
Net Weight (Depends on Model) Maximum	kg	13	13	14	15	13,5	13,5	14,5
Gross Weight (Depends on Model) Maximum	kg	14.25	14.25	15	16	14.75	14.75	15,5

TABLE TOP HOB DETAILS

TABLE TOP HOB DESIGNS



New Generation Gas On Glass Design



New Generation Design



Standard Design

TABLE TOP HOB AESTHETICS



New Generation Gas On Glass Table Top Hob Aesthetic



New Generation Table Top Hob Aesthetic



Standard Design "S-Type" Table Top Hob Aesthetic



Standard Design "R-Type" Table Top Hob Aesthetic



Standard Design "Smootline" Table Top Hob Aesthetic



Standard Design "Surface" Table Top Hob Aesthetic

TABLE TOP FRAME COLOR



White Painted



Black Painted



Inox Painted



Silver Painted



Stainless Steel
only available for gas on glass
table top hob



TTGGH-S2.01

STANDARD FEATURES

60cm gas on glass table top hob
4 gas burners
Front knob control
Enamel burner pan
Enamel burner caps and pan supports
Flame Safety Device

OPTIONAL FEATURES

White optical glass cooktop
White table top frame
One touch ignition
Inox clad knobs

TTGGH-S2.02

STANDARD FEATURES

60cm gas on glass table top hob
3 gas burners and 145mm hotplate
Front knob control
Black glass cooktop
Enamel burner pan supports
Flame Safety Device

OPTIONAL FEATURES

Cast Iron burner caps
Cast Iron pan supports
One touch ignition
Stainless steel table top frame
Inox clad knobs
Inox painted table top frame



TTGGH-S2.03

STANDARD FEATURES

60cm gas on glass table top hob
4 gas burners
Front knob control
Black glass cooktop
Enamel burner pan supports
Flame Safety Device

OPTIONAL FEATURES

Wok Burner
Cast Iron burner caps
Cast Iron pan supports
One touch ignition
Inox clad knobs
Black table top frame



TABLE TOP HOBS



TTGH-S2.01

STANDARD FEATURES

60 cm table top gas hob
New generation table top hob design
4 gas burners
Side knob control
Enamel cooktop
Enamel burner pan supports
Flame Safety Device

OPTIONAL FEATURES

One touch ignition

TTEH-S2.01

STANDARD FEATURES

60 cm table top electric hob
New generation table top hob design
4 solid hotplates
(2x145mm)+(2x180mm)
Side knob control
Enamel cooktop

OPTIONAL FEATURES

Rapid Hotplates (145mm and 180 mm)



TTGH-S2.02

STANDARD FEATURES

60 cm table top gas hob
New generation table top hob design
4 gas burners
Side knob control
Flame Safety Device

OPTIONAL FEATURES

Stainless steel cooktop
Wok Burner
One touch ignition
Cast iron pan support
Cast iron burner caps
Glass cover lid
Inox painted knobs



TTGH-S1.01

STANDARD FEATURES

60 cm table top gas hob
 Standard type table top hob design
 Flat R-type cooktop aesthetics
 3 gas burners
 Ø180mm hotplate
 Side knob control
 Enamel pan supports and burner caps
 Flame Safety Device

OPTIONAL FEATURES

Stainless steel cooktop
 Inox painted table top frame
 One touch ignition
 Black Knobs

TTEH-S1.02

STANDARD FEATURES

60 cm table top electrical hob
 Standard type table top hob design
 Flat S-type cooktop aesthetics
 4 solid hotplates
 (2x145mm)+(2x180mm)
 Side knob control

OPTIONAL FEATURES

Stainless steel cooktop
 Inox cladned knobs
 Inox painted table top frame



TTGH-S1.02

STANDARD FEATURES

60 cm table top gas hob
 Standard type table top hob design
 Smootline cooktop aesthetics
 3 gas burners
 Ø145mm hotplate
 Side knob control
 Enamel cooktop
 Enamel burner pan supports
 Flame Safety Device

OPTIONAL FEATURES

One touch ignition
 Inox painted knobs





TTGH-S1.03

STANDARD FEATURES

60 cm table top gas hob
Standard type table top hob design
Smoothline cooktop aesthetics
4 gas burners
Side knob control
Enamel burner caps and pan supports
Flame Safety Device

OPTIONAL FEATURES

Stainless steel cooktop
One touch ignition
Inox painted knobs
Inox painted table top frame

TTGH-S1.04

STANDARD FEATURES

60 cm table top gas hob
Standard type table top hob design
Flat R-type cooktop aesthetics
4 gas burners
Side knob control
Enamel cooktop
Enamel burner caps and pan supports
Flame Safety Device

OPTIONAL FEATURES

One touch ignition
Glass lid



TTGH-S1.05

STANDARD FEATURES

60 cm table top gas hob
Standard type table top hob design
Surface cooktop aesthetics
4 gas burners
Side knob control
Flame Safety Device

OPTIONAL FEATURES

Stainless steel cooktop
Wok Burner
Cast Iron burner caps and pan supports
One touch ignition
Inox painted table top frame
Glass lid
Black knobs

SPECIFICATIONS

BUILT IN														
Model	3200		3200 TURBO	2610		2400		2500		1800		1900		
Refrigerator Class	7		7	7		7		1		7		1		
Climatic Class	BGN (16 °C-32°C)		BGT/N (16 °C-43°C)	BGN (16 °C-32°C)		BGN (16 °C-32°C)		BGN (16 °C-32°C)		BGN (16 °C-32°C)		BGN (16 °C-32°C)	BGT/N (16 °C-43°C)	
Energy Class	A+	A	B	A+	A++	A++	A+	A++	A+	A++	A+	A++	A+	
Volume Total (gross)	lt	276	276	276	217	217	195	195	206	206	153	153	162	162
Volume Total (net)	lt	261	261	260	214	214	192	192	204	204	150	150	160	160
Volume refrigerator (gross)	lt	192	192	192	179	179	178	178	206	206	136	136	162	162
Volume refrigerator (net)	lt	189	189	188	176	176	175	175	204	204	133	133	160	160
Chiller Volume (net)	lt	-	-	-	-	-	-	-	-	-	-	-	-	-
Volume Freezer (gross)	lt	84	84	84	38	38	17	17	0	0	17	17	0	0
Volume Freezer (net)	lt	72	72	72	38	38	17	17	0	0	17	17	0	0
Performance (star rating)		4	4	4	4	4	4	4	-	-	4	4	-	-
Energy consumption	kWh/24h	0,715	0,936	1,408	0,622	0,488	0,450	0,573	0,272	0,346	0,414	0,529	0,261	0,343
Energy consumption	kWh/year	261	342	514	227	178	164	209	99	126	151	193	95	125
Freezing Capacity	kg/24h	4	5	4	2	2	2	2	-	-	2	2	-	-
Temperature Rise Time (-18°C to -9°C)	mins	660	660	550	960	960	664	664	-	-	720	720	-	-
Noise Emission	dB (A)	41	41	42	42	42	43	42	41	39	41	41	41	39
Defrost System Type Frigde/Freezer		Automatic/Manual	Automatic/Manual	Automatic/Manual	Automatic/Manual	Automatic/Manual	Automatic/Manual	Automatic/Manual	Automatic	Automatic	Automatic/Manual	Automatic/Manual	Automatic	Automatic
Built in		YES	YES	YES	YES	YES	YES	YES	YES	YES	YES	YES	YES	YES
Product dimensions (WxDxH)	mm	540x545x1770	540x545x1770	540x545x1770	540x545x1445	540x545x1445	540x545x1225	540x545x1225	540x545x1225	540x545x1225	540x545x1020	540x545x1020	540x545x1020	540x545x1020
Packaged dims (WxDxH) (double-wave carton pack) / standard	mm	584x600x1834	584x600x1834	584x600x1834	584x600x1509	584x600x1509	584x600x1289	584x600x1289	584x600x1289	584x600x1289	584x600x1084	584x600x1084	584x600x1084	584x600x1084
Loading Quantity / 40ft HC	pcs	100	100	100	133	133	160	160	160	160	160	160	160	160
Refrigerating Gas		R600a	R600a	R600a	R600a	R600a	R600a	R600a	R600a	R600a	R600a	R600a	R600a	R600a

BUILT IN														
Model	1400		1500		1450		1700		1650		3320			
Refrigerator Class	7		1		8		1		8		7			
Climatic Class	BGN (16 °C-32°C)		BGN (16°C-32°C)	BGT/N (16°C-43°C)	BGT/SN (10 °C-43°C)	BGST/N (16 °C-38°C)	BGSN (10 °C-32°C)		BGSN (10 °C-32°C)		BGN (16°C-32°C)			
Energy Class	A++	A+	A++	A+	A++	A+	A++	A+	A+	A	A++	A+		
Volume Total (gross)	lt	126	126	135	135	109	109	136	136	107	107	235	235	
Volume Total (net)	lt	123	123	134	134	99	99	133	133	93	93	223	223	
Volume refrigerator (gross)	lt	109	109	135	135	0	0	136	136	0	0	160	160	
Volume refrigerator (net)	lt	106	106	134	134	0	0	133	133	0	0	158	158	
Chiller Volume (net)	lt	-	-	-	-	-	-	-	-	-	-	-	-	
Volume Freezer (gross)	lt	17	17	0	0	109	109	0	0	107	107	75	75	
Volume Freezer (net)	lt	17	17	0	0	99	99	0	0	93	93	65	65	
Performance (star rating)		4	4	-	-	4	4	-	-	4	4	4	4	
Energy consumption	kWh/24h	0,392	0,499	0,255	0,332	0,433	0,534	0,247	0,316	0,484	0,635	0,523	0,665	
Energy consumption	kWh/year	143	182	93	121	158	195	90	115	177	232	191	243	
Freezing Capacity	kg/24h	2	2	-	-	8	8	-	-	9	9	3	3	
Temperature Rise Time (-18°C to -9°C)	mins	650	650	-	-	660	660	-	-	1080	1080	1140	1140	
Noise Emission	dB (A)	41	41	39	41	40	39	44	44	44	44	41	41	
Defrost System Type Frigde/Freezer		Automatic/Manual	Automatic/Manual	Automatic	Automatic	Manual	Manual	Automatic	Automatic	Manual	Manual	Automatic/Manual	Automatic/Manual	
Built in		YES	YES	YES	YES	YES	YES	YES	YES	YES	YES	YES	YES	
Product dimensions (WxDxH)	mm	540x545x875	540x545x875	540x545x875	540x545x875	540x545x875	540x545x875	595x548x818	595x548x818	595x548x818	595x548x818	540x545x1770	540x545x1770	
Packaged dims (WxDxH) (double-wave carton pack) / standard	mm	584x600x939	584x600x939	584x600x939	584x600x939	584x600x939	584x600x939	659x586x883	659x586x883	659x586x883	659x586x883	584x600x1834	584x600x1834	
Loading Quantity / 40ft HC	pcs	205	205	205	205	205	205	214	214	214	214	100	100	
Refrigerating Gas		R600a	R600a	R600a	R600a	R600a	R600a	R600a	R600a	R600a	R600a	R600a	R600a	

SPECIFICATIONS

BUILT IN												
Model		3310		1600	2791E		2795E		2795M		2761M	
Refrigerator Class		7		7	8		1		1		7	
Climatic Class		BGT/SN (10°C-43°C)	BGT/N (16°C-43°C)	BGSN (10 °C-32°C)	BGT/SN (10 °C-43°C)		BGT/SN (10 °C-43°C)		BGT/SN (10 °C-43°C)		BGN (16 °C-32°C)	
Energy Class		A++	A+	A+	A++	A+	A++	A+	A++	A+	A++	A+
Volume Total (gross)	lt	235	235	120	221	221	303	303	303	303	251	251
Volume Total (net)	lt	216	216	115	197	197	300	300	300	300	237	237
Volume refrigerator (gross)	lt	160	160	102	0	0	303	303	303	303	179	179
Volume refrigerator (net)	lt	158	158	98	0	0	300	300	300	300	179	179
Chiller Volume (net)	lt	-	-	-	---	---	---	---	---	---	---	---
Volume Freezer (gross)	lt	75	75	18	221	221	-	-	-	-	72	72
Volume Freezer (net)	lt	58	58	17	197	197	-	-	-	-	58	58
Performance (star rating)		4	4	4	4*	4*	---	---	---	---	4*	4*
Energy consumption	kWh/24h	0,584	0,743	0,468	0,638	0,813	0,309	0,397	0,309	0,397	0,547	0,698
Energy consumption	kWh/year	213	271	171	233	297	113	145	113	145	200	255
Freezing Capacity	kg/24h	2,6	2,6	2	9	9	---	---	---	---	3	3
Temperature Rise Time (-18°C to -9°C)	mins	750	750	626	TBD	540	-	-	-	-	TBD	TBD
Noise Emission	dB (A)	43	43	44	TBD	TBD	TBD	TBD	TBD	TBD	TBD	TBD
Defrost System Type Frigde/Freezer		Automatic	Automatic	Automatic/Manual	Automatic	Automatic	Manual	Manual	Manual	Manual	Automatic	Automatic
Built in		YES	YES	YES	YES	YES	YES	YES	YES	YES	YES	YES
Product dimensions (WxDxH)	mm	540X545X1770	540X545X1770	595X548X818	540x545x1770	540x545x1770	540x545x1770	540x545x1770	540x545x1770	540x545x1770	540x545x1770	540x545x1770
Packaged dims (WxDxH) (double-wave carton pack) / standard	mm	584x600x1834	584x600x1834	659X586X883	584x600x1834	584x600x1834	584x600x1834	584x600x1834	584x600x1834	584x600x1834	584x600x1834	584x600x1834
Loading Quantity/40ft HC	pcs	100	100	214	100	100	100	100	100	100	100	100
Refrigerating Gas		R600a	R600a	R600a	R600a	R600a	R600a	R600a	R600a	R600a	R600a	R600a

BUILT IN											
Model		2761E		2751M		2751E		2750M		2760M	
Refrigerator Class		7		7		7		7		7	
Climatic Class		BGN (16 °C-32°C)		BGN (16 °C-32°C)		BGN (16 °C-32°C)		BGN (16 °C-32°C)		BGN (16 °C-32°C)	
Energy Class		A++	A+	A++	A+	A++	A+	A++	A+	A++	A+
Volume Total (gross)	lt	251	251	245	245	245	245	245	245	251	251
Volume Total (net)	lt	237	237	227	227	227	227	235	235	243	243
Volume refrigerator (gross)	lt	179	179	146	146	146	146	146	146	179	179
Volume refrigerator (net)	lt	179	179	146	146	146	146	146	146	179	179
Chiller Volume (net)	lt	---	---	---	---	---	---	---	---	---	---
Volume Freezer (gross)	lt	72	72	99	99	99	99	99	99	72	72
Volume Freezer (net)	lt	58	58	81	81	81	81	89	89	64	64
Performance (star rating)		4*	4*	4*	4*	4*	4*	4*	4*	4*	4*
Energy consumption	kWh/24h	0,547	0,698	0,569	0,726	0,569	0,726	0,556	0,709	0,539	0,684
Energy consumption	kWh/year	200	255	208	265	208	265	203	259	197	250
Freezing Capacity	kg/24h	3	3	3	3	3	3	3	3	3	3
Temperature Rise Time (-18°C to -9°C)	mins	TBD	TBD	TBD	TBD	TBD	TBD	TBD	TBD	TBD	TBD
Noise Emission	dB (A)	TBD	TBD	TBD	TBD	TBD	TBD	TBD	TBD	TBD	TBD
Defrost System Type Frigde/Freezer		Automatic	Automatic	Automatic	Automatic	Automatic	Automatic	Automatic	Automatic	Automatic	Automatic
Built in		YES	YES	YES	YES	YES	YES	YES	YES	YES	YES
Product dimensions (WxDxH)	mm	540x545x1770	540x545x1770	540x545x1770	540x545x1770	540x545x1770	540x545x1770	540x545x1770	540x545x1770	540x545x1770	540x545x1770
Packaged dims (WxDxH) (double-wave carton pack) / standard	mm	584x600x1834	584x600x1834	584x600x1834	584x600x1834	584x600x1834	584x600x1834	584x600x1834	584x600x1834	584x600x1834	584x600x1834
Loading Quantity/40ft HC	pcs	100	100	100	100	100	100	100	100	100	100
Refrigerating Gas		R600a	R600a	R600a	R600a	R600a	R600a	R600a	R600a	R600a	R600a

SPECIFICATIONS

SEMI INTEGRATED - X&C SERIES 60cm Models	X11	X1A	X12	X1B	X13	X1C	X14
General Characteristics							
Number of place settings (PS)	12/13	12/13	12/13	12/13	12/13	12/13	12/13
Number of programs	2	2	3	3	4	4	5
Temperatures (°C)	50-65	50-65	50-65	50-65	40-50-65	40-50-65	40-50-65-70
Control type	full-electronic	full-electronic	full-electronic	full-electronic	full-electronic	full-electronic	full-electronic
Hidden heating element	Yes	Yes	Yes	Yes	Yes	Yes	Yes
Filter type	Metal/Plastic	Metal/Plastic	Metal/Plastic	Metal/Plastic	Metal/Plastic	Metal/Plastic	Metal/Plastic
Tub material	Stainless Steel	Stainless Steel	Stainless Steel	Stainless Steel	Stainless Steel	Stainless Steel	Stainless Steel
Turbidity sensor (Smart Wash)	-	-	-	-	-	-	-
Drying system	Mini Active/Super Active	Mini Active/Super Active	Mini Active/Super Active	Mini Active/Super Active	Mini Active/Super Active	Mini Active/Super Active	Mini Active/Super Active
Divisor system	-	-	-	-	-	-	-
Overflow & leakage protection	Yes	Yes	Yes	Yes	Yes	Yes	Yes
Heater protection	Yes	Yes	Yes	Yes	Yes	Yes	Yes
Circulation pump	Asynchronous	Asynchronous	Asynchronous	Asynchronous	Asynchronous	Asynchronous	Asynchronous
Auto Door	-	-	-	-	-	-	-
Water Box	-	-	-	-	-	-	-
Triple & Direct Wash	-	-	-	-	-	-	-
Wi-fi	-	-	-	-	-	-	-
Available Aesthetics	Camelia, Silva	Camelia, Silva	Camelia, Silva	Camelia, Silva	Camelia, Silva	Camelia, Silva	Camelia, Silva
Programs							
Prewash	-	-	-	-	-	-	-
Mini 18' (Jet Wash)	-	-	-	-	-	-	-
Quick 30' 40°C	-	-	-	-	Yes	Yes	Yes
Eco	Yes	Yes	Yes	Yes	Yes	Yes	Yes
Super 50' 65°C (Quick Clean)	-	-	Yes	Yes	Yes	Yes	Yes
Super 55' 60°C	-	-	-	-	-	-	-
Delicate 40°C	-	-	-	-	-	-	-
Normal 55°C	-	-	-	-	-	-	-
Daily 60°C	-	-	-	-	-	-	-
Dual Pro Wash 60°C	-	-	-	-	-	-	-
Hygiene 60°C	-	-	-	-	-	-	-
Hygiene 70°C	-	-	-	-	-	-	Yes
Intensive 65°C	Yes	Yes	Yes	Yes	Yes	Yes	Yes
Intensive 70°C	-	-	-	-	-	-	-
Auto Delicate 30°C - 50°C	-	-	-	-	-	-	-
Auto Normal 50°C - 60°C	-	-	-	-	-	-	-
Auto Intensive 60°C - 70°C	-	-	-	-	-	-	-
Extra Intensive 70°C (Prewash Button + Intensive 65°C)	-	-	-	-	-	-	-
Extra Hygiene 70°C (Prewash Button + Hygiene 60°C)	-	-	-	-	-	-	-
Steam Wash	-	-	-	-	-	-	-
Eco 5.4 lt	-	-	-	-	-	-	-
User Interface							
Start/Pause button	Yes	Yes	Yes	Yes	Yes	Yes	Yes
DISPLAY (delay start, remaining time)	-	Yes: LED	-	Yes: LED	-	Yes: LED	-
Prewash button	-	-	-	-	-	-	-
Program selection button	Knob	Knob	Knob	Knob	Knob	Knob	Knob
Delay timer option	Yes (3hr,6hr,9hr)	Yes (1-2-3-...-19hr)	Yes (3hr,6hr,9hr)	Yes (1-2-3-...-19hr)	Yes (3hr,6hr,9hr)	Yes (1-2-3-...-19hr)	Yes (3hr,6hr,9hr)
Eco Wash - Half load option (with 1 mode)	Yes	Yes	Yes	Yes	Yes	Yes	Yes
Eco Wash - Half load option (with 3 modes)	-	-	-	-	-	-	-
Tablet option	-	-	-	-	-	-	-
Extra Hygiene option	-	-	-	-	-	-	-
Extra Rinse option	-	-	-	-	-	-	-
Extra Drying option	-	-	-	-	-	-	-
Extra Silent option (Silent Wash)	-	-	-	-	-	-	-
Extra Fast option	-	-	-	-	-	-	-
Energy Save option	-	-	-	-	-	-	-
Rinse-aid indicator	Yes	Yes	Yes	Yes	Yes	Yes	Yes
Salt indicator	Yes	Yes	Yes	Yes	Yes	Yes	Yes
Washing cycle indicators	Yes	Yes	Yes	Yes	Yes	Yes	Yes
End of cycle indicator	Yes	Yes	Yes	Yes	Yes	Yes	Yes
Child Lock	-	Yes	-	Yes	-	Yes	-
Buzzer	-	-	-	-	-	-	-
InfoLED	-	-	-	-	-	-	-
Baskets & Accessories							
3rd basket (Easy Tray)	-	-	-	-	-	-	-
Upper basket type [mesh type/peg type]	(o)	(o)	(o)	(o)	(o)	(o)	(o)
Adjustable upper basket when empty	(o)	(o)	(o)	(o)	(o)	(o)	(o)
Adjustable upper basket when loaded	(o)	(o)	(o)	(o)	(o)	(o)	(o)
Number of mug shelves	2 (std)/4 (o)	2 (std)/4 (o)	2 (std)/4 (o)	2 (std)/4 (o)	2 (std)/4 (o)	2 (std)/4 (o)	2 (std)/4 (o)
Adjustable mug shelves (peg)	Yes	Yes	Yes	Yes	Yes	Yes	Yes
Adjustable mug shelves (mesh)	(o)	(o)	(o)	(o)	(o)	(o)	(o)
Mug shelves with soft touch rubber (peg)	(o)	(o)	(o)	(o)	(o)	(o)	(o)

SPECIFICATIONS

SEMI INTEGRATED - X&C SERIES 60cm Models	X11	X1A	X12	X1B	X13	X1C	X14
Baskets & Accessories							
Foldable racks on upper basket (peg)	fixed (std) /2 or 4 or 6 (o)	fixed (std) /2 or 4 or 6 (o)	fixed (std) /2 or 4 or 6 (o)	fixed (std) /2 or 4 or 6 (o)	fixed (std) /2 or 4 or 6 (o)	fixed (std) /2 or 4 or 6 (o)	fixed (std) /2 or 4 or 6 (o)
Foldable racks on lower basket	(o)	(o)	(o)	(o)	(o)	(o)	(o)
Wire basket handles	(o)	(o)	(o)	(o)	(o)	(o)	(o)
Plastic basket handles	(o)	(o)	(o)	(o)	(o)	(o)	(o)
Removable cutlery basket (Single piece)	(o)	(o)	(o)	(o)	(o)	(o)	(o)
Removable cutlery basket (Universal)	-	-	-	-	-	-	-
Removable cutlery basket (Modular) (2)	(o)	(o)	(o)	(o)	(o)	(o)	(o)
Removable cutlery basket (Sliding) (3)	(o)	(o)	(o)	(o)	(o)	(o)	(o)
Multi func. kit (Extra mug shelves + higher rear part on lower basket)	(o)	(o)	(o)	(o)	(o)	(o)	(o)
Bottle holder on lower basket	(o)	(o)	(o)	(o)	(o)	(o)	(o)
Wine stem support & Spoon rack on upper basket (2)	(o)	(o)	(o)	(o)	(o)	(o)	(o)
Wine glass holder on lower basket	(o) with 2 or more foldable racks	(o) with 2 or more foldable racks	(o) with 2 or more foldable racks	(o) with 2 or more foldable racks	(o) with 2 or more foldable racks	(o) with 2 or more foldable racks	(o) with 2 or more foldable racks
Top nozzle [rotating / fixed]	-	-	-	-	-	-	-
Aquastop external hose	(o)	(o)	(o)	(o)	(o)	(o)	(o)
Antibacterial filter	(o)	(o)	(o)	(o)	(o)	(o)	(o)
Interior light	-	-	-	-	-	-	-
Technical Data (4)							
Noise Level (dB(A))	57/54/52/49/47/45	57/54/52/49/47/45	57/54/52/49/47/45	57/54/52/49/47/45	57/54/52/49/47/45	57/54/52/49/47/45	57/54/52/49/47/45
Energy efficiency class	A++	A++	A++	A++	A++	A++	A++
Cleaning performance	A	A	A	A	A	A	A
Drying performance	A	A	A	A	A	A	A
Water consumption (lt)	12	12	12	12	12	12	12
Annual water consumption (lt/year)	3360	3360	3360	3360	3360	3360	3360
Program duration (min)	165	165	165	165	165	165	165
Energy consumption (kWh)	0.90/0.91	0.90/0.91	0.90/0.91	0.90/0.91	0.90/0.91	0.90/0.91	0.90/0.91
Annual energy consumption (kWh/year)	258/261	258/261	258/261	258/261	258/261	258/261	258/261
Off mode power consumption (W)	0,50	0,50	0,50	0,50	0,50	0,50	0,50
Left-on mode power consumption (W)	1,00	1,00	1,00	1,00	1,00	1,00	1,00
Duration of left-on mode (min)	N/A	N/A	N/A	N/A	N/A	N/A	N/A
Power rating (W) / Heating element (W)	1900/1800	1900/1800	1900/1800	1900/1800	1900/1800	1900/1800	1900/1800
Plug Type	EU / UK / Swiss / Italy / Israel / AU / NZ / China / Argentina / S.Africa	EU / UK / Swiss / Italy / Israel / AU / NZ / China / Argentina / S.Africa	EU / UK / Swiss / Italy / Israel / AU / NZ / China / Argentina / S.Africa	EU / UK / Swiss / Italy / Israel / AU / NZ / China / Argentina / S.Africa	EU / UK / Swiss / Italy / Israel / AU / NZ / China / Argentina / S.Africa	EU / UK / Swiss / Italy / Israel / AU / NZ / China / Argentina / S.Africa	EU / UK / Swiss / Italy / Israel / AU / NZ / China / Argentina / S.Africa
Power cord length (cm)	165 (EU) /180 (Others)	165 (EU) /180 (Others)	165 (EU) /180 (Others)	165 (EU) /180 (Others)	165 (EU) /180 (Others)	165 (EU) /180 (Others)	165 (EU) /180 (Others)
Water inlet hose length (cm)	147 (170 for Aquastop ex. hose)	147 (170 for Aquastop ex. hose)	147 (170 for Aquastop ex. hose)	147 (170 for Aquastop ex. hose)	147 (170 for Aquastop ex. hose)	147 (170 for Aquastop ex. hose)	147 (170 for Aquastop ex. hose)
Water outlet hose length (cm)	200	200	200	200	200	200	200
Voltage (V) / Frequency (Hz) / Fuse Rating (A)	220-240 / 50 / 10	220-240 / 50 / 10	220-240 / 50 / 10	220-240 / 50 / 10	220-240 / 50 / 10	220-240 / 50 / 10	220-240 / 50 / 10
Dimensions							
Height (cm)	82,0	82,0	82,0	82,0	82,0	82,0	82,0
Width (cm)	59,8	59,8	59,8	59,8	59,8	59,8	59,8
Depth (cm)	57,0	57,0	57,0	57,0	57,0	57,0	57,0
Height adjustment (+cm)	5	5	5	5	5	5	5
Adjustable Plinth for undertable usage (mm)	-	-	-	-	-	-	-
Possible adjustment of the plinth (horizontal/vertical) (mm / mm)	-	-	-	-	-	-	-
Height without worktop (cm)	-	-	-	-	-	-	-
Packed dimensions (Height x Width x Depth) (cm)	85.1 x 64.4 x 66.1	85.1 x 64.4 x 66.1	85.1 x 64.4 x 66.1	85.1 x 64.4 x 66.1	85.1 x 64.4 x 66.1	85.1 x 64.4 x 66.1	85.1 x 64.4 x 66.1
Stacking quantity (pcs)	5	5	5	5	5	5	5
Gross/Net weight (kg) (5)	43/41	43/41	43/41	43/41	43/41	43/41	43/41
Container loading (40"HC/40"/20")	162/108/54	162/108/54	162/108/54	162/108/54	162/108/54	162/108/54	162/108/54

SPECIFICATIONS

SEMI INTEGRATED - X&C SERIES 60cm Models	X1D	X15	X1E	X16	X1F	C21	C31	C41
General Characteristics								
Number of place settings (PS)	12/13	12/13	12/13	12/13	12/13	12/13	12/13	12/13/15
Number of programs	5	6	6	7	7	6	7	9+
Temperatures (°C)	40-50-65-70	40-50-65-70	40-50-65-70	40-50-65-70	40-50-65-70	40-50-65-70	40-50-65-70	Auto-30-40-50-60-70
Control type	full-electronic	full-electronic	full-electronic	full-electronic	full-electronic	full-electronic	full-electronic	full-electronic
Hidden heating element	Yes	Yes	Yes	Yes	Yes	Yes	Yes	Yes
Filter type	Metal/Plastic	Metal/Plastic	Metal/Plastic	Metal/Plastic	Metal/Plastic	Metal/Plastic	Metal/Plastic	Metal/Plastic
Tub material	Stainless Steel	Stainless Steel	Stainless Steel	Stainless Steel	Stainless Steel	Stainless Steel	Stainless Steel	Stainless Steel
Turbidity sensor (Smart Wash)	-	-	-	-	-	-	-	Yes
Drying system	Mini Active/ Super Active	Mini Active/ Super Active	Mini Active/ Super Active	Mini Active/ Super Active	Mini Active/ Super Active	Mini Active/ Super Active	Mini Active/ Super Active/ Turbo(1)	Mini Active/ Super Active/ Turbo(1)
Divisor system	-	-	-	-	-	Yes	Yes	Yes
Overflow & leakage protection	Yes	Yes	Yes	Yes	Yes	Yes	Yes	Yes
Heater protection	Yes	Yes	Yes	Yes	Yes	Yes	Yes	Yes
Circulation pump	Asynchronous	Asynchronous	Asynchronous	Asynchronous	Asynchronous	Asynchronous	Asynchronous	Asynchronous
Auto Door	-	-	-	-	-	-	-	-
Water Box	-	-	-	-	-	-	-	-
Triple & Direct Wash	-	-	-	-	-	-	-	-
Wi-fi	-	-	-	-	-	-	-	-
Available Aesthetics	Camelia, Silva	Camelia, Silva	Camelia, Silva	Camelia, Silva	Camelia, Silva	Silva	Silva	Silva
Programs								
Prewash	-	Yes	Yes	Yes	Yes	Yes (separate button)	Yes (separate button)	Yes (separate button)
Mini 18' (Jet Wash)	-	-	-	-	-	-	-	-
Quick 30' 40°C	Yes	Yes	Yes	Yes	Yes	Yes	Yes	Yes
Eco	Yes	Yes	Yes	Yes	Yes	Yes	Yes	Yes
Super 50' 65°C (Quick Clean)	Yes	Yes	Yes	Yes	Yes	Yes	Yes	-
Super 55' 60°C	-	-	-	-	-	-	-	Yes
Delicate 40°C	-	-	-	Yes	Yes	-	Yes	-
Normal 55°C	-	-	-	-	-	-	-	-
Daily 60°C	-	-	-	-	-	-	-	-
Dual Pro Wash 60°C	-	-	-	-	-	-	-	-
Hygiene 60°C	-	-	-	-	-	-	-	Yes
Hygiene 70°C	Yes	Yes	Yes	Yes	Yes	-	-	-
Intensive 65°C	Yes	Yes	Yes	Yes	Yes	Yes	Yes	-
Intensive 70°C	-	-	-	-	-	-	-	-
Auto Delicate 30°C - 50°C	-	-	-	-	-	-	-	Yes
Auto Normal 50°C - 60°C	-	-	-	-	-	-	-	Yes
Auto Intensive 60°C - 70°C	-	-	-	-	-	-	-	Yes
Extra Intensive 70°C (Prewash Button + Intensive 65°C)	-	-	-	-	-	Yes	Yes	-
Extra Hygiene 70°C (Prewash Button + Hygiene 60°C)	-	-	-	-	-	-	-	Yes
Steam Wash	-	-	-	-	-	-	-	-
Eco 5.4 lt	-	-	-	-	-	-	-	-
User Interface								
Start/Pause button	Yes	Yes	Yes	Yes	Yes	Yes	Yes	Yes
DISPLAY (delay start, remaining time)	Yes: LED	-	Yes: LED	-	Yes: LED	-	-	Yes: LED
Prewash button	-	-	-	-	-	Yes	Yes	Yes
Program selection button	Knob	Knob	Knob	Knob	Knob	Knob	Knob	Knob
Delay timer option	Yes (1-2-3-...-19hr)	Yes (3hr,6hr,9hr)	Yes (1-2-3-...-19hr)	Yes (3hr,6hr,9hr)	Yes (1-2-3-...-19hr)	Yes (3hr,6hr,9hr,12hr)	Yes (3hr,6hr,9hr,12hr)	Yes (1-2-3-...-19hr)
Eco Wash - Half load option (with 1 mode)	Yes	Yes	Yes	Yes	Yes	-	-	-
Eco Wash - Half load option (with 3 modes)	-	-	-	-	-	-	Yes	Yes
Tablet option	-	-	-	-	-	-	-	Yes
Extra Hygiene option	-	-	-	-	-	-	-	-
Extra Rinse option	-	-	-	-	-	-	-	-
Extra Drying option	-	-	-	-	-	-	-	-
Extra Silent option (Silent Wash)	-	-	-	-	-	-	-	-
Extra Fast option	-	-	-	-	-	-	-	-
Energy Save option	-	-	-	-	-	-	-	-
Rinse-aid indicator	Yes	Yes	Yes	Yes	Yes	Yes	Yes	Yes
Salt indicator	Yes	Yes	Yes	Yes	Yes	Yes	Yes	Yes
Washing cycle indicators	Yes	Yes	Yes	Yes	Yes	Yes	Yes	Yes
End of cycle indicator	Yes	Yes	Yes	Yes	Yes	Yes	Yes	Yes
Child Lock	Yes	-	Yes	-	Yes	Yes	Yes	Yes
Buzzer	-	-	-	-	-	-	-	-
InfoLED	-	-	-	-	-	-	-	-
Baskets & Accessories								
3rd basket (Easy Tray)	-	-	-	-	-	-	No(12ps), (o) (13ps)	No(12/13ps), Yes (15ps)
Upper basket type [mesh type/peg type]	(o)	(o)	(o)	(o)	(o)	(o)	(o)	(o)
Adjustable upper basket when empty	(o)	(o)	(o)	(o)	(o)	(o)	(o)	(o)
Adjustable upper basket when loaded	(o)	(o)	(o)	(o)	(o)	(o)	(o)	(o)
Number of mug shelves	2 (std)/4 (o)	2 (std)/4 (o)	2 (std)/4 (o)	2 (std)/4 (o)	2 (std)/4 (o)	2 (std)/4 (o)	2 (std)/4 (o)	2 (std)/4 (o)
Adjustable mug shelves (peg)	Yes	Yes	Yes	Yes	Yes	Yes	Yes	Yes

SPECIFICATIONS

SEMI INTEGRATED - X&C SERIES 60cm Models	X1D	X15	X1E	X16	X1F	C21	C31	C41	
Baskets & Accessories									
Adjustable mug shelves (mesh)	(o)	(o)	(o)	(o)	(o)	(o)	(o)	(o)	
Mug shelves with soft touch rubber (peg)	(o)	(o)	(o)	(o)	(o)	(o)	(o)	(o)	
Foldable racks on upper basket (peg)	fixed (std)/2 or 4 or 6 (o)	fixed (std)/2 or 4 or 6 (o)	fixed (std)/2 or 4 or 6 (o)	fixed (std)/2 or 4 or 6 (o)	fixed (std)/2 or 4 or 6 (o)	fixed (std)/2 or 4 or 6 (o)	fixed (std)/2 or 4 or 6 (o)	fixed (std)/2 or 4 or 6 (o)	
Foldable racks on lower basket	(o)	(o)	(o)	(o)	(o)	(o)	(o)	(o)	
Wire basket handles	(o)	(o)	(o)	(o)	(o)	(o)	(o)	(o)	
Plastic basket handles	(o)	(o)	(o)	(o)	(o)	(o)	(o)	(o)	
Removable cutlery basket (Single piece)	(o)	(o)	(o)	(o)	(o)	(o)	(o)(12ps) / No(13ps)	(o)(12ps) / No(13/15ps)	
Removable cutlery basket (Universal)	-	-	-	-	-	-	No(12ps) / (o)(13ps)	No(12ps) / (o)(13/15ps)	
Removable cutlery basket (Modular) (2)	(o)	(o)	(o)	(o)	(o)	(o)	(o)	(o)	
Removable cutlery basket (Sliding) (3)	(o)	(o)	(o)	(o)	(o)	(o)	(o)	(o)(12ps) / No(13/15ps)	
Multi func. kit (Extra mug shelves + higher rear part on lower basket)	(o)	(o)	(o)	(o)	(o)	(o)	(o)	(o)	
Bottle holder on lower basket	(o)	(o)	(o)	(o)	(o)	(o)	(o)	(o)	
Wine stem support & Spoon rack on upper basket (2)	(o)	(o)	(o)	(o)	(o)	(o)	(o)	(o)	
Wine glass holder on lower basket	(o) with 2 or more foldable racks	(o) with 2 or more foldable racks	(o) with 2 or more foldable racks	(o) with 2 or more foldable racks	(o) with 2 or more foldable racks	(o) with 2 or more foldable racks	(o) with 2 or more foldable racks	(o) with 2 or more foldable racks	
Top nozzle [rotating/fixed]	-	-	-	-	-	-	(o) fixed (12/13ps) / (Yes) rotating (3rd rack)	(o) fixed (12/13ps) / (Yes) rotating (15ps)	
Aquastop external hose	(o)	(o)	(o)	(o)	(o)	(o)	(o)	(o)	
Antibacterial filter	(o)	(o)	(o)	(o)	(o)	(o)	(o)	(o)	
Interior light	-	-	-	-	-	-	-	(o)	
Technical Data (4)									
Noise Level (dB(A))	57/54/52/49/47/45	57/54/52/49/47/45	57/54/52/49/47/45	57/54/52/49/47/45	57/54/52/49/47/45	57/54/52/49/47/45	54/52/49/47/45 (12/13ps) 49/47/45 (3rd rack)	54/52/49/47/45 (12/13ps) 49/47/45 (15ps)	
Energy efficiency class	A++	A++	A++	A++	A++	A++	A++	A++	
Cleaning performance	A	A	A	A	A	A	A	A	
Drying performance	A	A	A	A	A	A	A	A	
Water consumption (lt)	12	12	12	12	12	12	9	9	
Annual water consumption (lt/year)	3360	3360	3360	3360	3360	3360	2520	2520	
Program duration (min)	165	165	165	165	165	165	171	171	
Energy consumption (kWh)	0.90/0.91	0.90/0.91	0.90/0.91	0.90/0.91	0.90/0.91	0.90/0.91	0.90/0.91	0.90/0.91 / 0.94	
Annual energy consumption (kWh/year)	258/261	258/261	258/261	258/261	258/261	258/261	258/261	258/261/267	
Off mode power consumption (W)	0,50	0,50	0,50	0,50	0,50	0,50	0,50	0,50	
Left-on mode power consumption (W)	1,00	1,00	1,00	1,00	1,00	1,00	1,00	1,00	
Duration of left-on mode (min)	N/A	N/A	N/A	N/A	N/A	N/A	N/A	N/A	
Power rating (W) / Heating element (W)	1900/1800	1900/1800	1900/1800	1900/1800	1900/1800	1900/1800	1900/1800	1900/1800	
Plug Type	EU / UK / Swiss / Italy / Israel / AU / NZ / China / Argentina / S.Africa	EU / UK / Swiss / Italy / Israel / AU / NZ / China / Argentina / S.Africa	EU / UK / Swiss / Italy / Israel / AU / NZ / China / Argentina / S.Africa	EU / UK / Swiss / Italy / Israel / AU / NZ / China / Argentina / S.Africa	EU / UK / Swiss / Italy / Israel / AU / NZ / China / Argentina / S.Africa	EU / UK / Swiss / Italy / Israel / AU / NZ / China / Argentina / S.Africa	EU / UK / Swiss / Italy / Israel / AU / NZ / China / Argentina / S.Africa	EU / UK / Swiss / Italy / Israel / AU / NZ / China / Argentina / S.Africa	EU / UK / Swiss / Italy / Israel / AU / NZ / China / Argentina / S.Africa
Power cord length (cm)	165 (EU) / 180 (Others)	165 (EU) / 180 (Others)	165 (EU) / 180 (Others)	165 (EU) / 180 (Others)	165 (EU) / 180 (Others)	165 (EU) / 180 (Others)	165 (EU) / 180 (Others)	165 (EU) / 180 (Others)	
Water inlet hose length (cm)	147 (170 for Aquastop ex. hose)	147 (170 for Aquastop ex. hose)	147 (170 for Aquastop ex. hose)	147 (170 for Aquastop ex. hose)	147 (170 for Aquastop ex. hose)	147 (170 for Aquastop ex. hose)	147 (170 for Aquastop ex. hose)	147 (170 for Aquastop ex. hose)	
Water outlet hose length (cm)	200	200	200	200	200	200	200	200	
Voltage (V) / Frequency (Hz) / Fuse Rating (A)	220-240/50/10	220-240/50/10	220-240/50/10	220-240/50/10	220-240/50/10	220-240/50/10	220-240/50/10	220-240/50/10	
Dimensions									
Height (cm)	82,0	82,0	82,0	82,0	82,0	82,0	82,0	82,0	
Width (cm)	59,8	59,8	59,8	59,8	59,8	59,8	59,8	59,8	
Depth (cm)	57,0	57,0	57,0	57,0	57,0	57,0	57,0	57,0	
Height adjustment (+cm)	5	5	5	5	5	5	5	5	
Adjustable Plinth for undertable usage (mm)	-	-	-	-	-	-	-	-	
Possible adjustment of the plinth (horizontal/vertical) (mm/mm)	-	-	-	-	-	-	-	-	
Height without worktop (cm)	-	-	-	-	-	-	-	-	
Packed dimensions (Height x Width x Depth) (cm)	85.1 x 64.4 x 66.1	85.1 x 64.4 x 66.1	85.1 x 64.4 x 66.1	85.1 x 64.4 x 66.1	85.1 x 64.4 x 66.1	85.1 x 64.4 x 66.1	85.1 x 64.4 x 66.1	85.1 x 64.4 x 66.1	
Stacking quantity (pcs)	5	5	5	5	5	5	5	5	
Gross/Net weight (kg) (5)	43/41	43/41	43/41	43/41	43/41	43/41	43/41	43/41	
Container loading (40"HC/40"/20")	162/108/54	162/108/54	162/108/54	162/108/54	162/108/54	162/108/54	162/108/54	162/108/54	

(o) : Optional

(1) : Turbo fan drying system & 3rd basket are default for 15 PS models

(2) : Modular cutlery basket for 12/13 PS must be selected with wine stem support & spoon rack. Also wine stem support & spoon rack can be selected only for mesh type upper basket option.

(3) : Can be selected for lower basket with fixed type or with 4 foldable wire.

(4) : Based on the tests performed with Eco program in accordance with European Household Dishwasher Performance Standards

(5) : Gross/Net Weights are shown as reference in the table. It should be calculated based on the final product features created from this general spect table.

SPECIFICATIONS

SEMI INTEGRATED - Y SERIES 60cm Models	Y11	Y1A	Y12	Y1B	Y13	Y1C	Y14	Y1D
General Characteristics								
Number of place settings (PS)	12/13	12/13	12/13	12/13	12/13	12/13	12/13	12/13
Number of programs	2	2	3	3	4	4	5	5
Temperatures (°C)	50-65	50-65	50-65	50-65	40-50-65	40-50-65	40-50-65	40-50-65
Control type	full-electronic	full-electronic	full-electronic	full-electronic	full-electronic	full-electronic	full-electronic	full-electronic
Hidden heating element	Yes	Yes	Yes	Yes	Yes	Yes	Yes	Yes
Filter type	Metal/Plastic	Metal/Plastic	Metal/Plastic	Metal/Plastic	Metal/Plastic	Metal/Plastic	Metal/Plastic	Metal/Plastic
Tub material	Stainless Steel	Stainless Steel	Stainless Steel	Stainless Steel	Stainless Steel	Stainless Steel	Stainless Steel	Stainless Steel
Turbidity sensor (Smart Wash)	-	-	-	-	-	-	-	-
Drying system	Mini Active/ Super Active	Mini Active/ Super Active	Mini Active/ Super Active	Mini Active/ Super Active	Mini Active/ Super Active	Mini Active/ Super Active	Mini Active/ Super Active	Mini Active/ Super Active
Divisor system	-	-	-	-	-	-	-	-
Overflow & leakage protection	Yes	Yes	Yes	Yes	Yes	Yes	Yes	Yes
Heater protection	Yes	Yes	Yes	Yes	Yes	Yes	Yes	Yes
Circulation pump	Asynchronous	Asynchronous	Asynchronous	Asynchronous	Asynchronous	Asynchronous	Asynchronous	Asynchronous
Auto Door	-	-	-	-	-	-	-	-
Water Box	-	-	-	-	-	-	-	-
Triple & Direct Wash	-	-	-	-	-	-	-	-
Wi-fi	-	-	-	-	-	-	-	-
Available Aesthetics	Camelia Y, Silva Y	Camelia Y, Silva Y	Camelia Y, Silva Y	Camelia Y, Silva Y	Camelia Y, Silva Y	Camelia Y, Silva Y	Camelia Y, Silva Y	Camelia Y, Silva Y
Programs								
Prewash	-	-	-	-	-	-	-	-
Mini 18' (Jet Wash)	-	-	-	-	-	-	-	-
Quick 30' 40°C	-	-	-	-	Yes	Yes	Yes	Yes
Eco	Yes	Yes	Yes	Yes	Yes	Yes	Yes	Yes
Super 50' 65°C (Quick Clean)	-	-	Yes	Yes	Yes	Yes	Yes	Yes
Super 55' 60°C	-	-	-	-	-	-	-	-
Delicate 40°C	-	-	-	-	-	-	Yes	Yes
Normal 55°C	-	-	-	-	-	-	-	-
Daily 60°C	-	-	-	-	-	-	-	-
Dual Pro Wash 60°C	-	-	-	-	-	-	-	-
Hygiene 60°C	-	-	-	-	-	-	-	-
Hygiene 70°C	-	-	-	-	-	-	-	-
Intensive 65°C	Yes	Yes	Yes	Yes	Yes	Yes	Yes	Yes
Intensive 70°C	-	-	-	-	-	-	-	-
Auto Delicate 30°C - 50°C	-	-	-	-	-	-	-	-
Auto Normal 50°C - 60°C	-	-	-	-	-	-	-	-
Auto Intensive 60°C - 70°C	-	-	-	-	-	-	-	-
Extra Intensive 70°C (Prewash Button + Intensive 65°C)	-	-	-	-	-	-	-	-
Extra Hygiene 70°C (Prewash Button + Hygiene 60°C)	-	-	-	-	-	-	-	-
Steam Wash	-	-	-	-	-	-	-	-
Eco 5.4 lt	-	-	-	-	-	-	-	-
User Interface								
Start/Pause button	Yes	Yes	Yes	Yes	Yes	Yes	Yes	Yes
DISPLAY (delay start, remaining time)	-	Yes: LED	-	Yes: LED	-	Yes: LED	-	Yes: LED
Prewash button	-	-	-	-	-	-	-	-
Program selection button	Yes	Yes	Yes	Yes	Yes	Yes	Yes	Yes
Delay timer option	Yes (3hr,6hr,9hr)	Yes (1-2-3-...-19hr)	Yes (3hr,6hr,9hr)	Yes (1-2-3-...-19hr)	Yes (3hr,6hr,9hr)	Yes (1-2-3-...-19hr)	Yes (3hr,6hr,9hr)	Yes (1-2-3-...-19hr)
Eco Wash - Half load option (with 1 mode)	Yes	Yes	Yes	Yes	Yes	Yes	Yes	Yes
Eco Wash - Half load option (with 3 modes)	-	-	-	-	-	-	-	-
Tablet option	-	Yes	-	Yes	-	Yes	-	Yes
Extra Hygiene option	-	Yes	-	Yes	-	Yes	-	Yes
Extra Rinse option	-	Yes	-	Yes	-	Yes	-	Yes
Extra Drying option	-	Yes	-	Yes	-	Yes	-	Yes
Extra Silent option (Silent Wash)	-	-	-	-	-	-	-	-
Extra Fast option	-	-	-	-	-	-	-	-
Energy Save option	-	-	-	-	-	-	-	-
Rinse-aid indicator	Yes	Yes	Yes	Yes	Yes	Yes	Yes	Yes
Salt indicator	Yes	Yes	Yes	Yes	Yes	Yes	Yes	Yes
Washing cycle indicators	Yes	Yes	Yes	Yes	Yes	Yes	Yes	Yes
End of cycle indicator	Yes	Yes	Yes	Yes	Yes	Yes	Yes	Yes
Child Lock	-	Yes	-	Yes	-	Yes	-	Yes
Buzzer	-	-	-	-	-	-	-	-
InfoLED	-	-	-	-	-	-	-	-
Baskets & Accessories								
3rd basket (Easy Tray)	-	-	-	-	-	-	-	-
Upper basket type [mesh type/peg type]	(o)	(o)	(o)	(o)	(o)	(o)	(o)	(o)
Adjustable upper basket when empty	(o)	(o)	(o)	(o)	(o)	(o)	(o)	(o)
Adjustable upper basket when loaded	(o)	(o)	(o)	(o)	(o)	(o)	(o)	(o)
Number of mug shelves	2 (std) / 4 (o)	2 (std) / 4 (o)	2 (std) / 4 (o)	2 (std) / 4 (o)	2 (std) / 4 (o)	2 (std) / 4 (o)	2 (std) / 4 (o)	2 (std) / 4 (o)
Adjustable mug shelves (peg)	Yes	Yes	Yes	Yes	Yes	Yes	Yes	Yes
Adjustable mug shelves (mesh)	(o)	(o)	(o)	(o)	(o)	(o)	(o)	(o)

SPECIFICATIONS

SEMI INTEGRATED - Y SERIES 60cm Models	Y11	Y1A	Y12	Y1B	Y13	Y1C	Y14	Y1D
Baskets & Accessories								
Mug shelves with soft touch rubber (peg)	(o)	(o)	(o)	(o)	(o)	(o)	(o)	(o)
Foldable racks on upper basket (peg)	fixed (std) /2 or 4 or 6 (o)	fixed (std) /2 or 4 or 6 (o)	fixed (std) /2 or 4 or 6 (o)	fixed (std) /2 or 4 or 6 (o)	fixed (std) /2 or 4 or 6 (o)	fixed (std) /2 or 4 or 6 (o)	fixed (std) /2 or 4 or 6 (o)	fixed (std) /2 or 4 or 6 (o)
Foldable racks on lower basket	(o)	(o)	(o)	(o)	(o)	(o)	(o)	(o)
Wire basket handles	(o)	(o)	(o)	(o)	(o)	(o)	(o)	(o)
Plastic basket handles	(o)	(o)	(o)	(o)	(o)	(o)	(o)	(o)
Removable cutlery basket (Single piece)	(o)	(o)	(o)	(o)	(o)	(o)	(o)	(o)
Removable cutlery basket (Universal)	-	-	-	-	-	-	-	-
Removable cutlery basket (Modular) (2)	(o)	(o)	(o)	(o)	(o)	(o)	(o)	(o)
Removable cutlery basket (Sliding) (3)	(o)	(o)	(o)	(o)	(o)	(o)	(o)	(o)
Multi func. kit (Extra mug shelves + higher rear part on lower basket)	(o)	(o)	(o)	(o)	(o)	(o)	(o)	(o)
Bottle holder on lower basket	(o)	(o)	(o)	(o)	(o)	(o)	(o)	(o)
Wine stem support & Spoon rack on upper basket (2)	(o)	(o)	(o)	(o)	(o)	(o)	(o)	(o)
Wine glass holder on lower basket	(o) with 2 or more foldable racks	(o) with 2 or more foldable racks	(o) with 2 or more foldable racks	(o) with 2 or more foldable racks	(o) with 2 or more foldable racks	(o) with 2 or more foldable racks	(o) with 2 or more foldable racks	(o) with 2 or more foldable racks
Top nozzle [rotating / fixed]	-	-	-	-	-	-	-	-
Aquastop external hose	(o)	(o)	(o)	(o)	(o)	(o)	(o)	(o)
Antibacterial filter	(o)	(o)	(o)	(o)	(o)	(o)	(o)	(o)
Interior light	-	-	-	-	-	-	-	-
Technical Data (4)								
Noise Level (dB(A))	57/54/52/49/47/45	57/54/52/49/47/45	57/54/52/49/47/45	57/54/52/49/47/45	57/54/52/49/47/45	57/54/52/49/47/45	57/54/52/49/47/45	57/54/52/49/47/45
Energy efficiency class	A++	A++	A++	A++	A++	A++	A++	A++
Cleaning performance	A	A	A	A	A	A	A	A
Drying performance	A	A	A	A	A	A	A	A
Water consumption (lt)	12	12	12	12	12	12	12	12
Annual water consumption (lt/year)	3360	3360	3360	3360	3360	3360	3360	3360
Program duration (min)	165	165	165	165	165	165	165	165
Energy consumption (kWh)	0.90/0.91	0.90/0.91	0.90/0.91	0.90/0.91	0.90/0.91	0.90/0.91	0.90/0.91	0.90/0.91
Annual energy consumption (kWh/year)	258/261	258/261	258/261	258/261	258/261	258/261	258/261	258/261
Off mode power consumption (W)	0,50	0,50	0,50	0,50	0,50	0,50	0,50	0,50
Left-on mode power consumption (W)	1,00	1,00	1,00	1,00	1,00	1,00	1,00	1,00
Duration of left-on mode (min)	N/A	N/A	N/A	N/A	N/A	N/A	N/A	N/A
Power rating (W) / Heating element (W)	1900/1800	1900/1800	1900/1800	1900/1800	1900/1800	1900/1800	1900/1800	1900/1800
Plug Type	EU / UK / Swiss / Italy / Israel / AU / NZ / China / Argentina / S.Africa	EU / UK / Swiss / Italy / Israel / AU / NZ / China / Argentina / S.Africa	EU / UK / Swiss / Italy / Israel / AU / NZ / China / Argentina / S.Africa	EU / UK / Swiss / Italy / Israel / AU / NZ / China / Argentina / S.Africa	EU / UK / Swiss / Italy / Israel / AU / NZ / China / Argentina / S.Africa	EU / UK / Swiss / Italy / Israel / AU / NZ / China / Argentina / S.Africa	EU / UK / Swiss / Italy / Israel / AU / NZ / China / Argentina / S.Africa	EU / UK / Swiss / Italy / Israel / AU / NZ / China / Argentina / S.Africa
Power cord length (cm)	165 (EU) /180 (Others)	165 (EU) /180 (Others)	165 (EU) /180 (Others)	165 (EU) /180 (Others)	165 (EU) /180 (Others)	165 (EU) /180 (Others)	165 (EU) /180 (Others)	165 (EU) /180 (Others)
Water inlet hose length (cm)	147 (170 for Aquastop ex. hose)	147 (170 for Aquastop ex. hose)	147 (170 for Aquastop ex. hose)	147 (170 for Aquastop ex. hose)	147 (170 for Aquastop ex. hose)	147 (170 for Aquastop ex. hose)	147 (170 for Aquastop ex. hose)	147 (170 for Aquastop ex. hose)
Water outlet hose length (cm)	200	200	200	200	200	200	200	200
Voltage (V) / Frequency (Hz) / Fuse Rating (A)	220-240 / 50/10	220-240 / 50/10	220-240 / 50/10	220-240 / 50/10	220-240 / 50/10	220-240 / 50/10	220-240 / 50/10	220-240 / 50/10
Dimensions								
Height (cm)	82,0	82,0	82,0	82,0	82,0	82,0	82,0	82,0
Width (cm)	59,8	59,8	59,8	59,8	59,8	59,8	59,8	59,8
Depth (cm)	57,0	57,0	57,0	57,0	57,0	57,0	57,0	57,0
Height adjustment (+cm)	5	5	5	5	5	5	5	5
Adjustable Plinth for undertable usage (mm)	-	-	-	-	-	-	-	-
Possible adjustment of the plinth (horizontal / vertical) (mm / mm)	-	-	-	-	-	-	-	-
Height without worktop (cm)	-	-	-	-	-	-	-	-
Packed dimensions (Height x Width x Depth) (cm)	85.1 x 64.4 x 66.1	85.1 x 64.4 x 66.1	85.1 x 64.4 x 66.1	85.1 x 64.4 x 66.1	85.1 x 64.4 x 66.1	85.1 x 64.4 x 66.1	85.1 x 64.4 x 66.1	85.1 x 64.4 x 66.1
Stacking quantity (pcs)	5	5	5	5	5	5	5	5
Gross/Net weight (kg) (5)	43/41	43/41	43/41	43/41	43/41	43/41	43/41	43/41
Container loading (40"HC / 40"/20")	162/108/54	162/108/54	162/108/54	162/108/54	162/108/54	162/108/54	162/108/54	162/108/54

SPECIFICATIONS

SEMI INTEGRATED - Y SERIES 60cm Models	Y15	Y1E	Y1F	Y21	Y22	Y23	Y24	Y25	Y26
General Characteristics									
Number of place settings (PS)	12/13	12/13	12/13	12/13/15	12/13/15	12/13/15	12/13/15	12/13/15	12/13/15
Number of programs	6	6	7	6	7	8	9+	9+	9+
Temperatures (°C)	40-50-65	40-50-65-70	40-50-60-65	40-50-65	40-50-60-65	40-50-60-65	Auto-30-40-50-60-65-70	Auto-30-40-50-60-65-70	Auto-30-40-50-60-65-70
Control type	full-electronic	full-electronic	full-electronic	full-electronic	full-electronic	full-electronic	full-electronic	full-electronic	full-electronic
Hidden heating element	Yes	Yes	Yes	Yes	Yes	Yes	Yes	Yes	Yes
Filter type	Metal/Plastic	Metal/Plastic	Metal/Plastic	Metal/Plastic	Metal/Plastic	Metal/Plastic	Metal/Plastic	Metal	Metal
Tub material	Stainless Steel	Stainless Steel	Stainless Steel	Stainless Steel	Stainless Steel	Stainless Steel	Stainless Steel	Stainless Steel	Stainless Steel
Turbidity sensor (Smart Wash)	-	-	-	-	-	-	Yes	Yes	Yes
Drying system	Mini Active/ Super Active	Mini Active/ Super Active	Mini Active/ Super Active	Mini Active/ Super Active/ Turbo(1)	Mini Active/ Super Active/ Turbo(1)	Mini Active/ Super Active/ Turbo(1)	Mini Active/ Super Active/ Turbo(1)	Turbo	Turbo
Divisor system	-	-	-	Yes	Yes	Yes	Yes	Yes	Yes
Overflow & leakage protection	Yes	Yes	Yes	Yes	Yes	Yes	Yes	Yes	Yes
Heater protection	Yes	Yes	Yes	Yes	Yes	Yes	Yes	Yes	Yes
Circulation pump	Asynchronous	Asynchronous	Asynchronous	Asynchronous	Asynchronous	Asynchronous	Asynchronous	BLDC	BLDC
Auto Door	-	-	-	-	-	-	-	Yes	-
Water Box	-	-	-	-	-	-	-	-	-
Triple & Direct Wash	-	-	-	-	-	-	-	-	-
Wi-fi	-	-	-	-	-	-	-	-	-
Available Aesthetics	Camelia Y, Silva Y	Camelia Y, Silva Y	Camelia Y, Silva Y	Camelia Y, Silva Y	Camelia Y, Silva Y	Camelia Y, Silva Y	Camelia Y, Silva Y	Camelia Y, Silva Y	Camelia Y, Silva Y
Programs									
Prewash	Yes	Yes	Yes	Yes	Yes	Yes	Yes	Yes	Yes
Mini 18' (Jet Wash)	-	-	-	-	-	-	-	Yes	Yes
Quick 30' 40°C	Yes	Yes	Yes	Yes	Yes	Yes	Yes	Yes	Yes
Eco	Yes	Yes	Yes	Yes	Yes	Yes	Yes	Yes	Yes
Super 50' 65°C (Quick Clean)	Yes	Yes	Yes	Yes	Yes	Yes	Yes	Yes	Yes
Super 55' 60°C	-	-	-	-	-	-	-	-	-
Delicate 40°C	Yes	Yes	Yes	Yes	Yes	Yes	-	-	-
Normal 55°C	-	-	-	-	-	Yes	-	-	-
Daily 60°C	-	-	Yes	-	Yes	Yes	Yes	-	-
Dual Pro Wash 60°C	-	-	-	-	-	-	-	Yes	Yes
Hygiene 60°C	-	-	-	-	-	-	-	-	-
Hygiene 70°C	-	-	-	-	-	-	-	Yes	Yes
Intensive 65°C	Yes	Yes	Yes	Yes	Yes	Yes	-	-	-
Intensive 70°C	-	-	-	-	-	-	-	-	-
Auto Delicate 30°C - 50°C	-	-	-	-	-	-	Yes	-	-
Auto Normal 50°C - 60°C	-	-	-	-	-	-	Yes	-	-
Auto Intensive 60°C - 70°C	-	-	-	-	-	-	Yes	Yes	Yes
Extra Intensive 70°C (Prewash Button + Intensive 65°C)	-	-	-	-	-	-	-	-	-
Extra Hygiene 70°C (Prewash Button + Hygiene 60°C)	-	-	-	-	-	-	-	-	-
Steam Wash	-	-	-	-	-	-	Yes	Yes	Yes
Eco 5.4 lt	-	-	-	-	-	-	-	-	-
User Interface									
Start/Pause button	Yes	Yes	Yes	Yes	Yes	Yes	Yes	Yes	Yes
DISPLAY (delay start, remaining time)	-	Yes: LED	Yes: LED	Yes: LED	Yes: LED	Yes: LED	Yes: LED	Yes: LED	Yes: LED
Prewash button	-	-	-	-	-	-	-	-	-
Program selection button	Yes	Yes	Yes	Yes	Yes	Yes	Yes	Yes	Yes
Delay timer option	Yes (3hr,6hr,9hr)	Yes (1-2-3-...-19hr)	Yes (1-2-3-...-19hr)	Yes (1-2-3-...-19hr)	Yes (1-2-3-...-19hr)	Yes (1-2-3-...-19hr)	Yes (1-2-3-...-19hr)	Yes (1-2-3-...-19hr)	Yes (1-2-3-...-19hr)
Eco Wash - Half load option (with 1 mode)	Yes	Yes	Yes	-	-	-	-	-	-
Eco Wash - Half load option (with 3 modes)	-	-	-	Yes	Yes	Yes	Yes	Yes	Yes
Tablet option	-	Yes	Yes	Yes	Yes	Yes	Yes	Yes	Yes
Extra Hygiene option	-	Yes	Yes	Yes	Yes	Yes	Yes	-	-
Extra Rinse option	-	Yes	Yes	Yes	Yes	Yes	Yes	-	-
Extra Drying option	-	Yes	Yes	Yes	Yes	Yes	Yes	-	Yes
Extra Silent option (Silent Wash)	-	-	-	-	-	-	-	Yes	Yes
Extra Fast option	-	-	-	-	-	-	-	Yes	Yes
Energy Save option	-	-	-	-	-	-	-	Yes	-
Rinse-aid indicator	Yes	Yes	Yes	Yes	Yes	Yes	Yes	Yes	Yes
Salt indicator	Yes	Yes	Yes	Yes	Yes	Yes	Yes	Yes	Yes
Washing cycle indicators	Yes	Yes	Yes	Yes	Yes	Yes	Yes	Yes	Yes
End of cycle indicator	Yes	Yes	Yes	Yes	Yes	Yes	Yes	Yes	Yes
Child Lock	-	Yes	Yes	Yes	Yes	Yes	Yes	Yes	Yes
Buzzer	-	-	-	-	-	-	-	-	-
InfoLED	-	-	-	-	-	-	-	-	-
Baskets & Accessories									
3rd basket (Easy Tray)	-	-	-	No (12/13ps), Yes (15ps)	No (12/13ps), Yes (15ps)	No (12/13ps), Yes (15ps)	No (12/13ps), Yes (15ps)	No (12/13ps), Yes (15ps)	No (12/13ps), Yes (15ps)
Upper basket type [mesh type/peg type]	(o)	(o)	(o)	(o)	(o)	(o)	(o)	(o)	(o)
Adjustable upper basket when empty	(o)	(o)	(o)	(o)	(o)	(o)	(o)	(o)	(o)
Adjustable upper basket when loaded	(o)	(o)	(o)	(o)	(o)	(o)	(o)	(o)	(o)

SPECIFICATIONS

SEMI INTEGRATED - Y SERIES 60cm Models	Y15	Y1E	Y1F	Y21	Y22	Y23	Y24	Y25	Y26	
Baskets & Accessories										
Number of mug shelves	2 (std) / 4 (o)	2 (std) / 4 (o)	2 (std) / 4 (o)	2 (std) / 4 (o)	2 (std) / 4 (o)	2 (std) / 4 (o)	2 (std) / 4 (o)	2 (std) / 4 (o)	2 (std) / 4 (o)	
Adjustable mug shelves (peg)	Yes	Yes	Yes	Yes	Yes	Yes	Yes	Yes	Yes	
Adjustable mug shelves (mesh)	(o)	(o)	(o)	(o)	(o)	(o)	(o)	(o)	(o)	
Mug shelves with soft touch rubber (peg)	(o)	(o)	(o)	(o)	(o)	(o)	(o)	(o)	(o)	
Foldable racks on upper basket (peg)	fixed (std) / 2 or 4 or 6 (o)	fixed (std) / 2 or 4 or 6 (o)	fixed (std) / 2 or 4 or 6 (o)	fixed (std) / 2 or 4 or 6 (o)	fixed (std) / 2 or 4 or 6 (o)	fixed (std) / 2 or 4 or 6 (o)	fixed (std) / 2 or 4 or 6 (o)	fixed (std) / 2 or 4 or 6 (o)	fixed (std) / 2 or 4 or 6 (o)	
Foldable racks on lower basket	(o)	(o)	(o)	(o)	(o)	(o)	(o)	(o)	(o)	
Wire basket handles	(o)	(o)	(o)	(o)	(o)	(o)	(o)	(o)	(o)	
Plastic basket handles	(o)	(o)	(o)	(o)	(o)	(o)	(o)	(o)	(o)	
Removable cutlery basket (Single piece)	(o)	(o)	(o)	(o) (12/13ps) / No(15ps)	(o) (12/13ps) / No(15ps)	(o) (12/13ps) / No(15ps)	(o) (12/13ps) / No(15ps)	(o) (12/13ps) / No(15ps)	(o) (12/13ps) / No(15ps)	
Removable cutlery basket (Universal)	-	-	-	No(12/13ps) / (o) (15ps)	No(12/13ps) / (o) (15ps)	No(12/13ps) / (o) (15ps)	No(12/13ps) / (o) (15ps)	No(12/13ps) / (o) (15ps)	No(12/13ps) / (o) (15ps)	
Removable cutlery basket (Modular) (2)	(o)	(o)	(o)	(o)	(o)	(o)	(o)	(o)	(o)	
Removable cutlery basket (Sliding) (3)	(o)	(o)	(o)	(o) (12/13ps) / No(15ps)	(o) (12/13ps) / No(15ps)	(o) (12/13ps) / No(15ps)	(o) (12/13ps) / No(15ps)	(o) (12/13ps) / No(15ps)	(o) (12/13ps) / No(15ps)	
Multi func. kit (Extra mug shelves + higher rear part on lower basket)	(o)	(o)	(o)	(o)	(o)	(o)	(o)	(o)	(o)	
Bottle holder on lower basket	(o)	(o)	(o)	(o)	(o)	(o)	(o)	(o)	(o)	
Wine stem support & Spoon rack on upper basket (2)	(o)	(o)	(o)	(o)	(o)	(o)	(o)	(o)	(o)	
Wine glass holder on lower basket	(o) with 2 or more foldable racks	(o) with 2 or more foldable racks	(o) with 2 or more foldable racks	(o) with 2 or more foldable racks	(o) with 2 or more foldable racks	(o) with 2 or more foldable racks	(o) with 2 or more foldable racks	(o) with 2 or more foldable racks	(o) with 2 or more foldable racks	
Top nozzle [rotating / fixed]	-	-	-	(o) fixed (12/13ps) / (Yes) rotating (15ps)	(o) fixed (12/13ps) / (Yes) rotating (15ps)	(o) fixed (12/13ps) / (Yes) rotating (15ps)	(o) fixed (12/13ps) / (Yes) rotating (15ps)	(o) fixed (12/13ps) / (Yes) rotating (15ps)	(o) fixed (12/13ps) / (Yes) rotating (15ps)	
Aquastop external hose	(o)	(o)	(o)	(o)	(o)	(o)	(o)	(o)	(o)	
Antibacterial filter	(o)	(o)	(o)	(o)	(o)	(o)	(o)	(o)	(o)	
Interior light	-	-	-	(o)	(o)	(o)	(o)	(o)	(o)	
Technical Data (4)										
Noise Level (dB(A))	57/54/52/49/47/45	57/54/52/49/47/45	57/54/52/49/47/45	54/52/49/47/45 (12/13ps) / 49/47/45 (15ps)	54/52/49/47/45 (12/13ps) / 49/47/45 (15ps)	54/52/49/47/45 (12/13ps) / 49/47/45 (15ps)	54/52/49/47/45 (12/13ps) / 49/47/45 (15ps)	46/44 (12/13ps), 44/42 (15ps)	41 (12/13ps), 39 (15ps)	
Energy efficiency class	A++	A++	A++	A++	A++	A++	A++	A+++	A+++	
Cleaning performance	A	A	A	A	A	A	A	A	A	
Drying performance	A	A	A	A	A	A	A	A	A	
Water consumption (lt)	12	12	12	9	9	9	9	9	9	
Annual water consumption (lt/year)	3360	3360	3360	2520	2520	2520	2520	2520	2520	
Program duration (min)	165	165	165	171	171	171	171	239	176	
Energy consumption (kWh)	0.90 / 0.91	0.90 / 0.91	0.90 / 0.91	0.90 / 0.91 / 0.94	0.90 / 0.91 / 0.94	0.90 / 0.91 / 0.94	0.90 / 0.91 / 0.94	0.79 / 0.81 / 0.84	0.79 / 0.81 / 0.84	
Annual energy consumption (kWh/year)	258 / 261	258 / 261	258 / 261	258 / 261 / 267	258 / 261 / 267	258 / 261 / 267	258 / 261 / 267	227 / 233 / 241	225 / 233 / 239	
Off mode power consumption (W)	0,50	0,50	0,50	0,50	0,50	0,50	0,50	0,50	0,50	
Left-on mode power consumption (W)	1,00	1,00	1,00	1,00	1,00	1,00	1,00	1,00	1,00	
Duration of left-on mode (min)	N/A	N/A	N/A	N/A	N/A	N/A	N/A	N/A	N/A	
Power rating (W) / Heating element (W)	1900/1800	1900/1800	1900/1800	1900/1800	1900/1800	1900/1800	1900/1800	1900/1800	1900/1800	
Plug Type	EU / UK / Swiss / Italy / Israel / AU / NZ / China / Argentina / S.Africa	EU / UK / Swiss / Italy / Israel / AU / NZ / China / Argentina / S.Africa	EU / UK / Swiss / Italy / Israel / AU / NZ / China / Argentina / S.Africa	EU / UK / Swiss / Italy / Israel / AU / NZ / China / Argentina / S.Africa	EU / UK / Swiss / Italy / Israel / AU / NZ / China / Argentina / S.Africa	EU / UK / Swiss / Italy / Israel / AU / NZ / China / Argentina / S.Africa	EU / UK / Swiss / Italy / Israel / AU / NZ / China / Argentina / S.Africa	EU / UK / Swiss / Italy / Israel / AU / NZ / China / Argentina / S.Africa	EU / UK / Swiss / Italy / Israel / AU / NZ / China / Argentina / S.Africa	EU / UK / Swiss / Italy / Israel / AU / NZ / China / Argentina / S.Africa
Power cord length (cm)	165 (EU) / 180 (Others)	165 (EU) / 180 (Others)	165 (EU) / 180 (Others)	165 (EU) / 180 (Others)	165 (EU) / 180 (Others)	165 (EU) / 180 (Others)	165 (EU) / 180 (Others)	165 (EU) / 180 (Others)	165 (EU) / 180 (Others)	
Water inlet hose length (cm)	147 (170 for Aquastop ex. hose)	147 (170 for Aquastop ex. hose)	147 (170 for Aquastop ex. hose)	147 (170 for Aquastop ex. hose)	147 (170 for Aquastop ex. hose)	147 (170 for Aquastop ex. hose)	147 (170 for Aquastop ex. hose)	147 (170 for Aquastop ex. hose)	147 (170 for Aquastop ex. hose)	
Water outlet hose length (cm)	200	200	200	200	200	200	200	200	200	
Voltage (V) / Frequency (Hz) / Fuse Rating (A)	220-240 / 50 / 10	220-240 / 50 / 10	220-240 / 50 / 10	220-240 / 50 / 10	220-240 / 50 / 10	220-240 / 50 / 10	220-240 / 50 / 10	220-240 / 50 / 10	220-240 / 50 / 10	
Dimensions										
Height (cm)	82,0	82,0	82,0	82,0	82,0	82,0	82,0	82,0	82,0	
Width (cm)	59,8	59,8	59,8	59,8	59,8	59,8	59,8	59,8	59,8	
Depth (cm)	57,0	57,0	57,0	57,0	57,0	57,0	57,0	57,0	57,0	
Height adjustment (+cm)	5	5	5	5	5	5	5	5	5	
Adjustable Plinth for undertable usage (mm)	-	-	-	-	-	-	-	-	-	
Possible adjustment of the plinth (horizontal/vertical) (mm/mm)	-	-	-	-	-	-	-	-	-	
Height without worktop (cm)	-	-	-	-	-	-	-	-	-	
Packed dimensions (Height x Width x Depth) (cm)	85.1 x 64.4 x 66.1	85.1 x 64.4 x 66.1	85.1 x 64.4 x 66.1	85.1 x 64.4 x 66.1	85.1 x 64.4 x 66.1	85.1 x 64.4 x 66.1	85.1 x 64.4 x 66.1	85.1 x 64.4 x 66.1	85.1 x 64.4 x 66.1	
Stacking quantity (pcs)	5	5	5	5	5	5	5	5	5	
Gross/Net weight (kg) (5)	43/41	43/41	43/41	43/41	43/41	43/41	43/41	43/41	43/41	
Container loading (40"HC/40"/20")	162/108/54	162/108/54	162/108/54	162/108/54	162/108/54	162/108/54	162/108/54	162/108/54	162/108/54	

(o) : Optional

(1) : Turbo fan drying system & 3rd basket are default for 15 PS models

(2) : Modular cutlery basket for 12/13 PS must be selected with wine stem support & spoon rack. Also wine stem support & spoon rack can be selected only for mesh type upper basket option.

(3) : Can be selected for lower basket with fixed type or with 4 foldable wire.

(4) : Based on the tests performed with Eco program in accordance with European Household Dishwasher Performance Standards

(5) : Gross/Net Weights are shown as reference in the table. It should be calculated based on the final product features created from this general spect table.

SPECIFICATIONS

SEMI INTEGRATED - T SERIES 60cm Models	T11	T12	T13	T21	T24	T25	T26
General Characteristics							
Number of place settings (PS)	12/13	12/13	12/13	12/13/15	12/13/15	14	12/13/15
Number of programs	3	4	6	8+	8+	8+	8+
Temperatures (°C)	50-65	40-50-65	40-50-65	Auto-30-40-50-60-65-70	Auto-30-40-50-60-65-70	Auto-30-40-50-60-65-70	Auto-30-40-50-60-65-70
Control type	full-electronic	full-electronic	full-electronic	full-electronic	full-electronic	full-electronic	full-electronic
Hidden heating element	Yes	Yes	Yes	Yes	Yes	Yes	Yes
Filter type	Metal/Plastic	Metal/Plastic	Metal/Plastic	Metal/Plastic	Metal	Metal	Metal
Tube material	Stainless Steel	Stainless Steel	Stainless Steel	Stainless Steel	Stainless Steel	Stainless Steel	Stainless Steel
Turbidity sensor (Smart Wash)	-	-	-	Yes	Yes	Yes	Yes
Drying system	Mini Active/Super Active	Mini Active/Super Active	Mini Active/Super Active	Mini Active/Super Active/Turbo(1)	Turbo	Turbo	Turbo
Divisor system	-	-	-	Yes	Yes	Yes	Yes
Overflow & leakage protection	Yes	Yes	Yes	Yes	Yes	Yes	Yes
Heater protection	Yes	Yes	Yes	Yes	Yes	Yes	Yes
Circulation pump	Asynchronous	Asynchronous	Asynchronous	Asynchronous	BLDC	BLDC	BLDC
Auto Door	-	-	-	-	Yes	Yes	-
Water Box	-	-	-	-	-	Yes	-
Triple & Direct Wash	-	-	-	-	-	(o)	-
Wi-fi	-	-	-	-	-	-	-
Available Aesthetics	Amaranth	Amaranth	Amaranth	Amaranth	Amaranth	Amaranth	Amaranth
Programs							
Prewash	-	-	Yes	Yes	-	-	-
Mini 18' (Jet Wash)	-	-	-	-	Yes	Yes	Yes
Quick 30' 40°C	-	Yes	Yes	Yes	Yes	Yes	Yes
Eco	Yes	Yes	Yes	Yes	Yes	Yes	Yes
Super 50' 65°C (Quick Clean)	Yes	Yes	Yes	Yes	Yes	Yes	Yes
Super 55' 60°C	-	-	-	-	-	-	-
Delicate 40°C	-	-	Yes	-	-	-	-
Normal 55°C	-	-	-	-	-	-	-
Daily 60°C	-	-	-	Yes	-	-	-
Dual Pro Wash 60°C	-	-	-	-	Yes	Yes	Yes
Hygiene 60°C	-	-	-	-	-	-	-
Hygiene 70°C	-	-	-	-	Yes	Yes	Yes
Intensive 65°C	Yes	Yes	Yes	-	-	-	-
Intensive 70°C	-	-	-	-	-	-	-
Auto Delicate 30°C - 50°C	-	-	-	Yes	Yes	Yes	Yes
Auto Normal 50°C - 60°C	-	-	-	Yes	-	-	-
Auto Intensive 60°C - 70°C	-	-	-	Yes	Yes (50°C-70°C)	Yes (50°C-70°C)	Yes (50°C-70°C)
Extra Intensive 70°C (Prewash Button + Intensive 65°C)	-	-	-	-	-	-	-
Extra Hygiene 70°C (Prewash Button + Hygiene 60°C)	-	-	-	-	-	-	-
Steam Wash	-	-	-	-	-	-	-
Eco 5.4 lt	-	-	-	-	-	-	-
User Interface							
Start/Pause button	Yes	Yes	Yes	Yes	Yes	Yes	Yes
DISPLAY (delay start, remaining time)	-	Yes: LED	Yes: LED	Yes: LED	Yes: LED	Yes: LED	Yes: LED
Prewash button	-	-	-	-	-	-	-
Program selection button	Yes	Yes	Yes	Yes	Yes	Yes	Yes
Delay timer option	-	Yes (1-2-3-...-24hr)	Yes (1-2-3-...-24hr)	Yes (1-2-3-...-24hr)	Yes (1-2-3-...-24hr)	Yes (1-2-3-...-24hr)	Yes (1-2-3-...-24hr)
Eco Wash - Half load option (with 1 mode)	Yes	Yes	Yes	-	-	-	-
Eco Wash - Half load option (with 3 modes)	-	-	-	Yes	Yes	Yes	Yes
Tablet option	-	-	Yes	Yes	Yes	Yes	Yes
Extra Hygiene option	-	-	Yes	Yes	-	-	-
Extra Rinse option	-	-	-	Yes	-	-	-
Extra Drying option	-	-	-	Yes	-	-	Yes
Extra Silent option (Silent Wash)	-	-	-	-	Yes	Yes	Yes
Extra Fast option	-	-	-	-	Yes	Yes	Yes
Energy Save option	-	-	-	-	Yes	Yes	-
Rinse-aid indicator	Yes	Yes	Yes	Yes	Yes	Yes	Yes
Salt indicator	Yes	Yes	Yes	Yes	Yes	Yes	Yes
Washing cycle indicators	Yes	Yes	Yes	Yes	Yes	Yes	Yes
End of cycle indicator	Yes	Yes	Yes	Yes	Yes	Yes	Yes
Child Lock	Yes	Yes	Yes	Yes	Yes	Yes	Yes
Buzzer	-	-	-	-	-	-	-
InfoLED	-	-	-	-	-	-	-
Baskets & Accessories							
3rd basket (Easy Tray)	-	-	-	No(12/13ps), Yes (15ps)	No(12/13ps), Yes (15ps)	Yes	No(12/13ps), Yes (15ps)
Upper basket type [mesh type/peg type]	(o)	(o)	(o)	(o)	(o)	Peg	(o)
Adjustable upper basket when empty	(o)	(o)	(o)	(o)	(o)	Yes	(o)
Adjustable upper basket when loaded	(o)	(o)	(o)	(o)	(o)	(o)	(o)
Number of mug shelves	2 (std)/4 (o)	2 (std)/4 (o)	2 (std)/4 (o)	2 (std)/4 (o)	2 (std)/4 (o)	2 (std)/4 (o)	2 (std)/4 (o)
Adjustable mug shelves (peg)	Yes	Yes	Yes	Yes	Yes	Yes	Yes
Adjustable mug shelves (mesh)	(o)	(o)	(o)	(o)	(o)	-	(o)
Mug shelves with soft touch rubber (peg)	(o)	(o)	(o)	(o)	(o)	(o)	(o)
Foldable racks on upper basket (peg)	fixed (std)/2 or 4 or 6 (o)	fixed (std)/2 or 4 or 6 (o)	fixed (std)/2 or 4 or 6 (o)	fixed (std)/2 or 4 or 6 (o)	fixed (std)/2 or 4 or 6 (o)	4 or 6 (o)	fixed (std)/2 or 4 or 6 (o)
Foldable racks on lower basket	(o)	(o)	(o)	(o)	(o)	Yes	(o)
Wire basket handles	(o)	(o)	(o)	(o)	(o)	-	(o)
Plastic basket handles	(o)	(o)	(o)	(o)	(o)	Yes	(o)
Removable cutlery basket (Single piece)	(o)	(o)	(o)	(o) (12/13ps) / No(15ps)	(o) (12/13ps) / No(15ps)	-	(o) (12/13ps) / No(15ps)
Removable cutlery basket (Universal)	-	-	-	No(12/13ps) / (o) (15ps)	No(12/13ps) / (o) (15ps)	(o)	No(12/13ps) / (o) (15ps)

SPECIFICATIONS

SEMI INTEGRATED - T SERIES 60cm Models	T11	T12	T13	T21	T24	T25	T26
General Characteristics							
Removable cutlery basket (Modular) (2)	(o)	(o)	(o)	(o)	(o)	(o)	(o)
Removable cutlery basket (Sliding) (3)	(o)	(o)	(o)	(o) (12/13ps) / No(15ps)	(o) (12/13ps) / No(15ps)	-	(o) (12/13ps) / No(15ps)
Multi func. kit (Extra mug shelves + higher rear part on lower basket)	(o)	(o)	(o)	(o)	(o)	(o)	(o)
Bottle holder on lower basket	(o)	(o)	(o)	(o)	(o)	(o)	(o)
Wine stem support & Spoon rack on upper basket (2)	(o)	(o)	(o)	(o)	(o)	-	(o)
Wine glass holder on lower basket	(o) with 2 or more foldable racks	(o) with 2 or more foldable racks	(o) with 2 or more foldable racks	(o) with 2 or more foldable racks	(o) with 2 or more foldable racks	(o) with 2 or more foldable racks	(o) with 2 or more foldable racks
Top nozzle [rotating / fixed]	-	-	-	(o) fixed (12/13ps) / (Yes) rotating (15ps)	(o) fixed (12/13ps) / (Yes) rotating (15ps)	(Yes) rotating	(o) fixed (12/13ps) / (Yes) rotating (15ps)
Aquastop external hose	(o)	(o)	(o)	(o)	(o)	(o)	(o)
Antibacterial filter	(o)	(o)	(o)	(o)	(o)	(o)	(o)
Interior light	-	-	-	(o)	(o)	-	(o)
Technical Data (4)							
Noise Level (dB(A))	57/54/52/49/47/45	57/54/52/49/47/45	57/54/52/49/47/45	54/52/49/47/45 (12/13ps) 49/47/45 (15ps)	46/44 (12/13ps), 44/42 (15ps)	44	41 (12/13ps), 39 (15ps)
Energy efficiency class	A++	A++	A++	A++	A+++	A+++ -20%	A+++
Cleaning performance	A	A	A	A	A	A	A
Drying performance	A	A	A	A	A	A	A
Water consumption (lt)	12	12	12	9	9	9	9
Annual water consumption (lt/year)	3360	3360	3360	2520	2520	2520	2520
Program duration (min)	169	169	169	171	239	207	176
Energy consumption (kWh)	0.90/0.91	0.90/0.91	0.90/0.91	0.90/0.91/0.94	0.79/0.81/0.84	0,66	0.79/0.81/0.84
Annual energy consumption (kWh/year)	258/261	258/261	258/261	258/261/267	225/233/239	189	225/233/239
Off mode power consumption (W)	0,50	0,50	0,50	0,50	0,10	0,10	0,10
Left-on mode power consumption (W)	1,00	1,00	1,00	1,00	1,00	1,00	1,00
Duration of left-on mode (min)	N/A	N/A	N/A	N/A	N/A	N/A	N/A
Power rating (W) / Heating element (W)	1900/1800	1900/1800	1900/1800	1900/1800	1900/1800	1900/1800	1900/1800
Plug Type	EU /UK /Swiss /Italy /Israel /AU/NZ /China /Argentina /S.Africa	EU /UK /Swiss /Italy /Israel /AU/NZ /China /Argentina /S.Africa	EU /UK /Swiss /Italy /Israel /AU/NZ /China /Argentina /S.Africa	EU /UK /Swiss /Italy /Israel /AU/NZ /China /Argentina /S.Africa	EU /UK /Swiss /Italy /Israel /AU/NZ /China /Argentina /S.Africa	EU /UK /Swiss /Italy /Israel /AU/NZ /China /Argentina /S.Africa	EU /UK /Swiss /Italy /Israel /AU/NZ /China /Argentina /S.Africa
Power cord length (cm)	165 (EU) /180 (Others)	165 (EU) /180 (Others)	165 (EU) /180 (Others)	165 (EU) /180 (Others)	165 (EU) /180 (Others)	165 (EU) /180 (Others)	165 (EU) /180 (Others)
Water inlet hose length (cm)	147 (170 for Aquastop ex. hose)	147 (170 for Aquastop ex. hose)	147 (170 for Aquastop ex. hose)	147 (170 for Aquastop ex. hose)	147 (170 for Aquastop ex. hose)	147 (170 for Aquastop ex. hose)	147 (170 for Aquastop ex. hose)
Water outlet hose length (cm)	200	200	200	200	200	200	200
Voltage (V) / Frequency (Hz) / Fuse Rating (A)	220-240/50/10	220-240/50/10	220-240/50/10	220-240/50/10	220-240/50/10	220-240/50/10	220-240/50/10
Dimensions							
Height (cm)	82,0	82,0	82,0	82,0	82,0	82,0	82,0
Width (cm)	59,8	59,8	59,8	59,8	59,8	59,8	59,8
Depth (cm)	57,0	57,0	57,0	57,0	57,0	57,0	57,0
Height adjustment (+cm)	5	5	5	5	5	5	5
Adjustable Plinth for undertable usage (mm)	-	-	-	-	-	-	-
Possible adjustment of the plinth (horizontal/vertical) (mm /mm)	-	-	-	-	-	-	-
Height without worktop (cm)	-	-	-	-	-	-	-
Packed dimensions (Height x Width x Depth) (cm)	85.1 x 64.4 x 66.1	85.1 x 64.4 x 66.1	85.1 x 64.4 x 66.1	85.1 x 64.4 x 66.1	85.1 x 64.4 x 66.1	85.1 x 64.4 x 66.1	85.1 x 64.4 x 66.1
Stacking quantity (pcs)	5	5	5	5	5	5	5
Gross/Net weight (kg)(5)	43/41	43/41	43/41	43/41	43/41	43/41	43/41
Container loading (40"HC/40"/20")	162/108/54	162/108/54	162/108/54	162/108/54	162/108/54	162/108/54	162/108/54

(o) : Optional

(1) : Turbo fan drying system & 3rd basket are default for 15 PS models

(2) : Modular cutlery basket for 12/13 PS must be selected with wine stem support & spoon rack. Also wine stem support & spoon rack can be selected only for mesh type upper basket option.

(3) : Can be selected for lower basket with fixed type or with 4 foldable wire.

(4) : Based on the tests performed with Eco program in accordance with European Household Dishwasher Performance Standards

(5) : Gross/Net Weights are shown as reference in the table. It should be calculated based on the final product features created from this general spect table.

SPECIFICATIONS

SEMI INTEGRATED - T3X (LED) SERIES 60cm Models	T31 LED	T32 LED	T34 LED	T35 LED	T36 LED
General Characteristics					
Number of place settings (PS)*	12/13/15	12/13/15	12/13/15	14	12/13/15
Number of programs	6+	8+	8+	8+	8+
Temperatures (°C)	Auto-30-40-50-60-65-70	Auto-30-40-50-60-65-70	Auto-30-40-50-60-65-70	Auto-30-40-50-60-65-70	Auto-30-40-50-60-65-70
Control type	full-electronic	full-electronic	full-electronic	full-electronic	full-electronic
Hidden heating element	Yes	Yes	Yes	Yes	Yes
Filter type	Metal/Plastic	Metal/Plastic	Metal	Metal	Metal
Tube material	Stainless Steel	Stainless Steel	Stainless Steel	Stainless Steel	Stainless Steel
Turbidity sensor (Smart Wash)	Yes	Yes	Yes	Yes	Yes
Drying system	Mini Active/Super Active/ Turbo(1)	Mini Active/Super Active/ Turbo(1)	Turbo	Turbo	Turbo
Divisor system	Yes	Yes	Yes	Yes	Yes
Overflow & leakage protection	Yes	Yes	Yes	Yes	Yes
Heater protection	Yes	Yes	Yes	Yes	Yes
Circulation pump	Asynchronous	Asynchronous	BLDC	BLDC	BLDC
Auto Door	-	-	Yes	Yes	-
Water Box	-	-	-	Yes	-
Triple & Direct Wash	(o)	(o)	(o)	(o)	-
Wi-fi	-	-	-	-	-
Available Aesthetics	Ares, Patara	Ares, Patara	Ares, Patara	Ares, Patara	Ares, Patara
Programs					
Prewash	Yes	Yes	-	-	-
Mini 18' (Jet Wash)	Yes	Yes	Yes	Yes	Yes
Quick 30' 40°C	Yes	Yes	Yes	Yes	Yes
Eco	Yes	Yes	Yes	Yes	Yes
Super 50' 65°C (Quick Clean)	Yes	Yes	Yes	Yes	Yes
Super 55' 60°C	-	-	-	-	-
Delicate 40°C	-	-	-	-	-
Normal 55°C	-	-	-	-	-
Daily 60°C	-	-	-	-	-
Dual Pro Wash 60°C	-	-	Yes	Yes	Yes
Hygiene 60°C	-	-	-	-	-
Hygiene 70°C	-	-	Yes	Yes	Yes
Intensive 65°C	-	-	-	-	-
Intensive 70°C	-	-	-	-	-
Auto Delicate 30°C - 50°C	-	Yes	Yes	Yes	Yes
Auto Normal 50°C - 60°C	-	Yes	-	-	-
Auto Intensive 60°C - 70°C	Yes	Yes	Yes (50°C - 70°C)	Yes (50°C - 70°C)	Yes (50°C - 70°C)
Extra Intensive 70°C (Prewash Button + Intensive 65°C)	-	-	-	-	-
Extra Hygiene 70°C (Prewash Button + Hygiene 60°C)	-	-	-	-	-
Steam Wash	-	-	-	-	-
Eco 5.4 lt	-	-	-	-	-
User Interface					
Start/Pause button	Yes	Yes	Yes	Yes	Yes
DISPLAY (delay start, remaining time)	Yes: Icon LED	Yes: Icon LED	Yes: Icon LED	Yes: Icon LED	Yes: Icon LED
Prewash button	-	-	-	-	-
Program selection button	Yes	Yes	Yes	Yes	Yes
Delay timer option	Yes (1-2-3-...-24hr)	Yes (1-2-3-...-24hr)	Yes (1-2-3-...-24hr)	Yes (1-2-3-...-24hr)	Yes (1-2-3-...-24hr)
Eco Wash - Half load option (with 1 mode)	-	-	-	-	-
Eco Wash - Half load option (with 3 modes)	Yes	Yes	Yes	Yes	Yes
Tablet option	Yes	Yes	Yes	Yes	Yes
Extra Hygiene option	Yes	Yes	-	-	-
Extra Rinse option	-	-	-	-	-
Extra Drying option	Yes	Yes	-	-	Yes
Extra Silent option (Silent Wash)	-	-	Yes	Yes	Yes
Extra Fast option	-	-	Yes	Yes	Yes
Energy Save option	-	-	Yes	Yes	-
Rinse-aid indicator	Yes	Yes	Yes	Yes	Yes
Salt indicator	Yes	Yes	Yes	Yes	Yes
Washing cycle indicators	Yes	Yes	Yes	Yes	Yes
End of cycle indicator	-	-	-	-	Yes
Child Lock	Yes	Yes	Yes	Yes	Yes
Buzzer	-	-	-	-	-
InfoLED	-	-	-	-	-
Baskets & Accessories					
3rd basket (Easy Tray)	No(12/13ps), Yes (15ps)	No(12/13ps), Yes (15ps)	No(12/13ps), Yes (15ps)	Yes	No(12/13ps), Yes (15ps)
Upper basket type [mesh type/peg type]	(o)	(o)	(o)	Peg	(o)
Adjustable upper basket when empty	(o)	(o)	(o)	Yes	(o)
Adjustable upper basket when loaded	(o)	(o)	(o)	(o)	(o)
Number of mug shelves	2 (std) / 4 (o)	2 (std) / 4 (o)	2 (std) / 4 (o)	2 (std) / 4 (o)	2 (std) / 4 (o)
Adjustable mug shelves (peg)	Yes	Yes	Yes	Yes	Yes
Adjustable mug shelves (mesh)	(o)	(o)	(o)	-	(o)

SPECIFICATIONS

SEMI INTEGRATED - T3X (LED) SERIES 60cm Models	T31 LED	T32 LED	T34 LED	T35 LED	T36 LED
General Characteristics					
Mug shelves with soft touch rubber (peg)	(o)	(o)	(o)	(o)	(o)
Foldable racks on upper basket (peg)	fixed (std) /2 or 4 or 6 (o)	fixed (std) /2 or 4 or 6 (o)	fixed (std) /2 or 4 or 6 (o)	4 or 6 (o)	fixed (std) /2 or 4 or 6 (o)
Foldable racks on lower basket	(o)	(o)	(o)	Yes	(o)
Wire basket handles	(o)	(o)	(o)	-	(o)
Plastic basket handles	(o)	(o)	(o)	Yes	(o)
Removable cutlery basket (Single piece)	(o) (12/13ps) / No(15ps)	(o) (12/13ps) / No(15ps)	(o) (12/13ps) / No(15ps)	-	(o) (12/13ps) / No(15ps)
Removable cutlery basket (Universal)	No(12/13ps) / (o) (15ps)	No(12/13ps) / (o) (15ps)	No(12/13ps) / (o) (15ps)	(o)	No(12/13ps) / (o) (15ps)
Removable cutlery basket (Modular) (2)	(o)	(o)	(o)	(o)	(o)
Removable cutlery basket (Sliding) (3)	(o) (12/13ps)/No(15ps)	(o) (12/13ps)/No(15ps)	(o) (12/13ps)/No(15ps)	-	(o) (12/13ps) / No(15ps)
Multi func. kit (Extra mug shelves + higher rear part on lower basket)	(o)	(o)	(o)	(o)	(o)
Bottle holder on lower basket	(o)	(o)	(o)	(o)	(o)
Wine stem support & Spoon rack on upper basket (2)	(o)	(o)	(o)	-	(o)
Wine glass holder on lower basket	(o) with 2 or more foldable racks	(o) with 2 or more foldable racks	(o) with 2 or more foldable racks	(o) with 2 or more foldable racks	(o) with 2 or more foldable racks
Top nozzle [rotating /fixed]	(o) fixed (12/13ps) / (Yes) rotating (15ps)	(o) fixed (12/13ps) / (Yes) rotating (15ps)	(o) fixed (12/13ps) / (Yes) rotating (15ps)	(Yes) rotating	(o) fixed (12/13ps) / (Yes) rotating (15ps)
Aquastop external hose	(o)	(o)	(o)	(o)	(o)
Antibacterial filter	(o)	(o)	(o)	(o)	(o)
Interior light	(o)	(o)	(o)	-	(o)
Technical Data (4)					
Noise Level (dB(A))	54/52/49/47/45 (12/13ps) 49/47/45 (15ps)	54/52/49/47/45 (12/13ps) 49/47/45 (15ps)	46/44 (12/13ps), 44/42 (15ps)	44	41 (12/13ps), 39 (15ps)
Energy efficiency class	A++	A++	A+++	A+++ -20%	A+++
Cleaning performance	A	A	A	A	A
Drying performance	A	A	A	A	A
Water consumption (lt)	9	9	9	9	9
Annual water consumption (lt/year)	2520	2520	2520	2520	2520
Program duration (min)	171	171	239	207	176
Energy consumption (kWh)	0.90/0.91/0.94	0.90/0.91/0.94	0.79/0.81/0.84	0,66	0.79/0.81/ 0.84
Annual energy consumption (kWh/year)	258/261/267	258/261/267	225/233/239	189	225/233/239
Off mode power consumption (W)	0,50	0,50	0,10	0,10	0,10
Left-on mode power consumption (W)	1,00	1,00	1,00	1,00	1,00
Duration of left-on mode (min)	N/A	N/A	N/A	N/A	N/A
Power rating (W) / Heating element (W)	1900/1800	1900/1800	1900/1800	1900/1800	1900/1800
Plug Type	EU/UK/Swiss/Italy/Israel /AU/NZ/China/Argentina /S.Africa	EU/UK/Swiss/Italy/Israel /AU/NZ/China/Argentina /S.Africa	EU/UK/Swiss/Italy/Israel /AU/NZ/China/Argentina /S.Africa	EU/UK/Swiss/Italy/Israel /AU/NZ/China/Argentina /S.Africa	EU/UK/Swiss/Italy/Israel /AU/NZ/China/Argentina /S.Africa
Power cord length (cm)	165 (EU)/180 (Others)	165 (EU)/180 (Others)	165 (EU)/180 (Others)	165 (EU)/180 (Others)	165 (EU)/180 (Others)
Water inlet hose length (cm)	147 (170 for Aquastop ex. hose)	147 (170 for Aquastop ex. hose)	147 (170 for Aquastop ex. hose)	147 (170 for Aquastop ex. hose)	147 (170 for Aquastop ex. hose)
Water outlet hose length (cm)	200	200	200	200	200
Voltage (V) / Frequency (Hz) / Fuse Rating (A)	220-240/50/10	220-240/50/10	220-240/50/10	220-240/50/10	220-240/50/10
Dimensions					
Height (cm)	82,0	82,0	82,0	82,0	82,0
Width (cm)	59,8	59,8	59,8	59,8	59,8
Depth (cm)	57,0	57,0	57,0	57,0	57,0
Height adjustment (+cm)	5	5	5	5	5
Adjustable Plinth for undertable usage (mm)	-	-	-	-	-
Possible adjustment of the plinth (horizontal/vertical) (mm/mm)	-	-	-	-	-
Height without worktop (cm)	-	-	-	-	-
Packed dimensions (Height x Width x Depth) (cm)	85.1 x 64.4 x 66.1	85.1 x 64.4 x 66.1	85.1 x 64.4 x 66.1	85.1 x 64.4 x 66.1	85.1 x 64.4 x 66.1
Stacking quantity (pcs)	5	5	5	5	5
Gross/Net weight (kg) (5)	43/41	43/41	43/41	43/41	43/41
Container loading (40"HC/40"/20")	162/108/54	162/108/54	162/108/54	162/108/54	162/108/54

(o) : Optional

(1) : Turbo fan drying system & 3rd basket are default for 15 PS models

(2) : Modular cutlery basket for 12/13 PS must be selected with wine stem support & spoon rack. Also wine stem support & spoon rack can be selected only for mesh type upper basket option.

(3) : Can be selected for lower basket with fixed type or with 4 foldable wire.

(4) : Based on the tests performed with Eco program in accordance with European Household Dishwasher Performance Standards

(5) : Gross/Net Weights are shown as reference in the table. It should be calculated based on the final product features created from this general spect table.

SPECIFICATIONS

FULLY INTEGRATED - 60cm Models	D13	D21	D41	D51	D52	D53
General Characteristics						
Number of place settings (PS)	12/13	12/13	12/13/15	12/13	12/13/15	15
Number of programs	4	5	9+	6	8+	8+
Temperatures (°C)	50-65	40-50-65-70	Auto-30-40-50-60-70	30-40-50-60-65	Auto-30-40-50-60-65-70	Auto-30-40-50-60-65-70
Control type	full-electronic	full-electronic	full-electronic	Touch control	Touch control	Touch control
Hidden heating element	Yes	Yes	Yes	Yes	Yes	Yes
Filter type	Metal/Plastic	Metal/Plastic	Metal/Plastic	Metal/Plastic	Metal/Plastic	Metal
Tube material	Stainless Steel	Stainless Steel	Stainless Steel	Stainless Steel	Stainless Steel	Stainless Steel
Turbidity sensor (Smart Wash)	-	-	Yes	-	Yes	Yes
Drying system	Mini Active/Super Active	Mini Active/Super Active	Mini Active/Super Active/Turbo(1)	Mini Active/Super Active	Mini Active/Super Active/Turbo(1)	Turbo
Divisor system	-	-	Yes	-	Yes	Yes
Overflow & leakage protection	Yes	Yes	Yes	Yes	Yes	Yes
Heater protection	Yes	Yes	Yes	Yes	Yes	Yes
Circulation pump	Asynchronous	Asynchronous	Asynchronous	Asynchronous	Asynchronous	BLDC
Auto Door	-	-	-	-	-	Yes
Water Box	-	-	-	-	-	-
Triple & Direct Wash	-	-	-	-	-	-
Wi-fi	-	-	-	-	-	-
Available Aesthetics	Astrum, Rhea	Astrum, Rhea	Astrum, Rhea	Freya, Freya (Inox look)	Freya, Freya (Inox look)	Freya, Freya (Inox look)
Programs						
Prewash	Yes	Yes	Yes	-	-	-
Mini 18' (Jet Wash)	-	-	-	Yes	Yes	Yes
Quick 30' 40°C	-	Yes	Yes	Yes	Yes	Yes
Eco	Yes	Yes	Yes	Yes	Yes	Yes
Super 50' 65°C (Quick Clean)	Yes	Yes	-	Yes	Yes	Yes
Super 55' 60°C	-	-	Yes	-	-	-
Delicate 40°C	-	-	-	-	-	-
Normal 55°C	-	-	-	-	-	-
Daily 60°C	-	-	-	-	-	-
Dual Pro Wash 60°C	-	-	-	-	-	Yes
Hygiene 60°C	-	-	Yes	Yes	Yes	Yes
Hygiene 70°C	-	-	-	-	-	-
Intensive 65°C	Yes	-	-	Yes	-	-
Intensive 70°C	-	Yes	-	-	-	-
Auto Delicate 30°C - 50°C	-	-	Yes	-	Yes	Yes
Auto Normal 50°C - 60°C	-	-	Yes	-	Yes	-
Auto Intensive 60°C - 70°C	-	-	Yes	-	Yes	Yes (50°C-70°C)
Extra Intensive 70°C (Prewash Button + Intensive 65°C)	-	-	-	-	-	-
Extra Hygiene 70°C (Prewash Button + Hygiene 60°C)	-	-	Yes	-	-	-
Steam Wash	-	-	-	-	-	-
Eco 5.4 lt	-	-	-	-	-	-
User Interface	-	-	-	-	-	-
Start/Pause button	-	-	-	-	-	-
DISPLAY (delay start, remaining time)	-	-	Yes: LED Hidden display	Yes: Icon LED Hidden display	Yes: Icon LED Hidden display	Yes: Icon LED Hidden display
Prewash button	-	-	Yes	-	-	-
Program selection button	Yes	Yes	Yes	Yes	Yes	Yes
Delay timer option	-	Yes (3hr,6hr,9hr)	Yes (1-2-3-...-19hr)	Yes (1-2-3-...-19hr)	Yes (1-2-3-...-19hr)	Yes (1-2-3-...-19hr)
Eco Wash - Half load option (with 1 mode)	-	-	-	Yes	-	-
Eco Wash - Half load option (with 3 modes)	-	-	Yes	-	Yes	Yes
Tablet option	-	-	Yes	Yes	Yes	Yes
Extra Hygiene option	-	-	-	-	-	-
Extra Rinse option	-	-	-	-	Yes	-
Extra Drying option	-	-	-	-	-	-
Extra Silent option (Silent Wash)	-	-	-	-	-	Yes
Extra Fast option	-	-	-	-	-	Yes
Energy Save option	-	-	-	-	-	Yes
Rinse-aid indicator	Yes	Yes	Yes	Yes	Yes	Yes
Salt indicator	Yes	Yes	Yes	Yes	Yes	Yes
Washing cycle indicators	-	-	-	-	-	-
End of cycle indicator	Yes	Yes	Yes	-	-	-
Child Lock	-	-	-	-	-	-
Buzzer	Yes	Yes	Yes	Yes	Yes	Yes
InfoLED	-	-	-	(o)	(o)	(o)
Baskets & Accessories						
3rd basket (Easy Tray)	-	-	No(12/13ps), Yes (15ps)	-	No(12/13ps), Yes (15ps)	Yes
Upper basket type [mesh type/peg type]	(o)	(o)	(o)	(o)	(o)	Peg
Adjustable upper basket when empty	(o)	(o)	(o)	(o)	(o)	Yes
Adjustable upper basket when loaded	(o)	(o)	(o)	(o)	(o)	(o)
Number of mug shelves	2 (std)/4 (o)	2 (std)/4 (o)	2 (std)/4 (o)	2 (std)/4 (o)	2 (std)/4 (o)	4
Adjustable mug shelves (peg)	Yes	Yes	Yes	Yes	Yes	Yes
Adjustable mug shelves (mesh)	(o)	(o)	(o)	(o)	(o)	-

SPECIFICATIONS

FULLY INTEGRATED - 60cm Models	D13	D21	D41	D51	D52	D53
Baskets & Accessories						
Mug shelves with soft touch rubber (peg)	(o)	(o)	(o)	(o)	(o)	(o)
Foldable racks on upper basket (peg)	fixed (std)/2 or 4 or 6 (o)	fixed (std)/2 or 4 or 6 (o)	fixed (std)/2 or 4 or 6 (o)	fixed (std)/2 or 4 or 6 (o)	fixed (std)/2 or 4 or 6 (o)	4 or 6 (o)
Foldable racks on lower basket	(o)	(o)	(o)	(o)	(o)	Yes
Wire basket handles	(o)	(o)	(o)	(o)	(o)	-
Plastic basket handles	(o)	(o)	(o)	(o)	(o)	Yes
Removable cutlery basket (Single piece)	(o)	(o)	(o) (12/13ps) / No(15ps)	(o)	(o) (12/13ps) / No(15ps)	-
Removable cutlery basket (Universal)	-	-	No(12/13ps) / (o) (15ps)	-	No(12/13ps) / (o) (15ps)	(o)
Removable cutlery basket (Modular) (2)	(o)	(o)	(o)	(o)	(o)	(o)
Removable cutlery basket (Sliding) (3)	(o)	(o)	(o) (12/13ps) / No(15ps)	(o)	(o) (12/13ps) / No(15ps)	-
Multi func. kit (Extra mug shelves + higher rear part on lower basket)	(o)	(o)	(o)	(o)	(o)	(o)
Bottle holder on lower basket	(o)	(o)	(o)	(o)	(o)	(o)
Wine stem support & Spoon rack on upper basket (2)	(o)	(o)	(o)	(o)	(o)	-
Wine glass holder on lower basket	(o) with 2 or more foldable racks	(o) with 2 or more foldable racks	(o) with 2 or more foldable racks	(o) with 2 or more foldable racks	(o) with 2 or more foldable racks	(o) with 2 or more foldable racks
Top nozzle [rotating / fixed]	-	-	(o) fixed (12/13ps) / (Yes) rotating (15ps)	-	(o) fixed (12/13ps) / (Yes) rotating (15ps)	(Yes) rotating
Aquastop external hose	(o)	(o)	(o)	(o)	(o)	(o)
Antibacterial filter	(o)	(o)	(o)	(o)	(o)	(o)
Interior light	-	(o)	(o)	-	(o)	(o)
Technical Data (4)						
Noise Level (dB(A))	57/54/52/49/47/45	57/54/52/49/47/45	54/52/49/47/45 (12/13ps) / 49/47/45 (15ps)	57/54/52/49/47/45	54/52/49/47/45 (12/13ps) / 49/47/45 (15ps)	44
Energy efficiency class	A++	A++	A++	A++	A++	A+++
Cleaning performance	A	A	A	A	A	A
Drying performance	A	A	A	A	A	A
Water consumption (lt)	12	12	9	12	9	9
Annual water consumption (lt/year)	3360	3360	2520	3360	2520	2520
Program duration (min)	187	187	162	187	171	195
Energy consumption (kWh)	0.90/0.91	0.90/0.91	0.90/0.91/0.94	0.90/0.91	0.90/0.91/0.94	0.84
Annual energy consumption (kWh/year)	258/261	258/261	258/261/267	258/261	258/261/267	239
Off mode power consumption (W)	0,50	0,50	0,50	0,50	0,50	0,50
Left-on mode power consumption (W)	1,00	1,00	1,00	1,00	1,00	1,00
Duration of left-on mode (min)	N/A	N/A	N/A	N/A	N/A	N/A
Power rating (W) / Heating element (W)	1900/1800	1900/1800	1900/1800	1900/1800	1900/1800	1900/1800
Plug Type	EU / UK / Swiss / Italy / Israel / AU / NZ / China / Argentina / S.Africa	EU / UK / Swiss / Italy / Israel / AU / NZ / China / Argentina / S.Africa	EU / UK / Swiss / Italy / Israel / AU / NZ / China / Argentina / S.Africa	EU / UK / Swiss / Italy / Israel / AU / NZ / China / Argentina / S.Africa	EU / UK / Swiss / Italy / Israel / AU / NZ / China / Argentina / S.Africa	EU / UK / Swiss / Italy / Israel / AU / NZ / China / Argentina / S.Africa
Power cord length (cm)	165 (EU) / 180 (Others)	165 (EU) / 180 (Others)	165 (EU) / 180 (Others)	165 (EU) / 180 (Others)	165 (EU) / 180 (Others)	165 (EU) / 180 (Others)
Water inlet hose length (cm)	147 (170 for Aquastop ex. hose)	147 (170 for Aquastop ex. hose)	147 (170 for Aquastop ex. hose)	147 (170 for Aquastop ex. hose)	147 (170 for Aquastop ex. hose)	147 (170 for Aquastop ex. hose)
Water outlet hose length (cm)	200	200	200	200	200	200
Voltage (V) / Frequency (Hz) / Fuse Rating (A)	220-240 / 50 / 10	220-240 / 50 / 10	220-240 / 50 / 10	220-240 / 50 / 10	220-240 / 50 / 10	220-240 / 50 / 10
Dimensions						
Height (cm)	82,0	82,0	82,0	82,0	82,0	82,0
Width (cm)	59,8	59,8	59,8	59,8	59,8	59,8
Depth (cm)	55,0	55,0	55,0	55,0	55,0	55,0
Height adjustment (+cm)	5	5	5	5	5	5
Adjustable Plinth for undertable usage (mm)	-	-	-	-	-	-
Possible adjustment of the plinth (horizontal/vertical) (mm/mm)	-	-	-	-	-	-
Height without worktop (cm)	-	-	-	-	-	-
Packed dimensions (Height x Width x Depth) (cm)	85.1 x 64.4 x 66.1	85.1 x 64.4 x 66.1	85.1 x 64.4 x 66.1	85.1 x 64.4 x 66.1	85.1 x 64.4 x 66.1	85.1 x 64.4 x 66.1
Stacking quantity (pcs)	5	5	5	5	5	5
Gross/Net weight (kg)(5)	40/38	40/38	40/38	40/38	40/38	40/38
Container loading (40"HC/40"/20")	162/108/54	162/108/54	162/108/54	162/108/54	162/108/54	162/108/54

(o) : Optional

(1) : Turbo fan drying system & 3rd basket are default for 15ps models

(2) : Modular cutlery basket for 12/13 PS must be selected with wine stem support & spoon rack. Also wine stem support & spoon rack can be selected only for mesh type upper basket option.

(3) : Can be selected for lower basket with fixed type or with 4 foldable wire.

(4) : Based on the tests performed with Eco program in accordance with European Household Dishwasher Performance Standards

(5) : Gross/Net Weights are shown as reference in the table. It should be calculated based on the final product features created from this general spect table.

SPECIFICATIONS

SEMI INTEGRATED - X&T SERIES 45cm Models	X11* 45cm	X1A* 45cm	X12* 45cm	X1B* 45cm	X13 45cm	X1C 45cm	X14* 45cm	X1D* 45cm	X15 45cm
General Characteristics									
Number of place settings (PS)	10	10	10	10	10	10	10	10	10
Number of programs	2	2	3	3	4	4	5	5	6
Temperatures (°C)	50-65	50-65	50-65	50-65	50-65	50-65	40-50-65-70	40-50-65-70	40-50-65-70
Control type	full-electronic	full-electronic	full-electronic	full-electronic	full-electronic	full-electronic	full-electronic	full-electronic	full-electronic
Hidden heating element	Yes	Yes	Yes	Yes	Yes	Yes	Yes	Yes	Yes
Filter type	Metal	Metal	Metal	Metal	Metal	Metal	Metal	Metal	Metal
Tube material	Stainless Steel	Stainless Steel	Stainless Steel	Stainless Steel	Stainless Steel	Stainless Steel	Stainless Steel	Stainless Steel	Stainless Steel
Turbidity sensor (Smart Wash)	-	-	-	-	-	-	-	-	-
Drying system	Mini Active/ Super Active	Mini Active/ Super Active	Mini Active/ Super Active	Mini Active/ Super Active	Mini Active/ Super Active	Mini Active/ Super Active	Mini Active/ Super Active	Mini Active/ Super Active	Mini Active/ Super Active
Divisor system	-	-	-	-	-	-	-	-	-
Overflow & leakage protection	Yes	Yes	Yes	Yes	Yes	Yes	Yes	Yes	Yes
Heater protection	Yes	Yes	Yes	Yes	Yes	Yes	Yes	Yes	Yes
Circulation pump	Asynchronous	Asynchronous	Asynchronous	Asynchronous	Asynchronous	Asynchronous	Asynchronous	Asynchronous	Asynchronous
Auto Door	-	-	-	-	-	-	-	-	-
Water Box	-	-	-	-	-	-	-	-	-
Triple & Direct Wash	-	-	-	-	-	-	-	-	-
Wi-fi	-	-	-	-	-	-	-	-	-
Available Aesthetics	Orchis	Orchis	Orchis	Orchis	Orchis	Orchis	Orchis	Orchis	Orchis
Programs									
Prewash	-	-	-	-	Yes	Yes	-	-	Yes
Mini 18' (Jet Wash)	-	-	-	-	-	-	-	-	-
Quick 30' 40°C	-	-	-	-	-	-	Yes	Yes	Yes
Eco	Yes	Yes	Yes	Yes	Yes	Yes	Yes	Yes	Yes
Super 50' 65°C (Quick Clean)	-	-	Yes	Yes	Yes	Yes	Yes	Yes	Yes
Super 55' 60°C	-	-	-	-	-	-	-	-	-
Delicate 40°C	-	-	-	-	-	-	-	-	-
Normal 55°C	-	-	-	-	-	-	-	-	-
Daily 60°C	-	-	-	-	-	-	-	-	-
Dual Pro Wash 60°C	-	-	-	-	-	-	-	-	-
Hygiene 60°C	-	-	-	-	-	-	-	-	-
Hygiene 70°C	-	-	-	-	-	-	Yes	Yes	Yes
Intensive 65°C	Yes	Yes	Yes	Yes	Yes	Yes	Yes	Yes	Yes
Intensive 70°C	-	-	-	-	-	-	-	-	-
Auto Delicate 30°C - 50°C	-	-	-	-	-	-	-	-	-
Auto Normal 50°C - 60°C	-	-	-	-	-	-	-	-	-
Auto Intensive 60°C - 70°C	-	-	-	-	-	-	-	-	-
Extra Intensive 70°C (Prewash Button + Intensive 65°C)	-	-	-	-	-	-	-	-	-
Extra Hygiene 70°C (Prewash Button + Hygiene 60°C)	-	-	-	-	-	-	-	-	-
Steam Wash	-	-	-	-	-	-	-	-	-
Eco 5.4 lt	-	-	-	-	-	-	-	-	-
User Interface									
Start/Pause button	Yes	Yes	Yes	Yes	Yes	Yes	Yes	Yes	Yes
DISPLAY (delay start, remaining time)	-	Yes: LED	-	Yes: LED	-	Yes: LED	-	Yes: LED	-
Prewash button	-	-	-	-	-	-	-	-	-
Program selection button	Knob	Knob	Knob	Knob	Knob	Knob	Knob	Knob	Knob
Delay timer option	Yes (3hr,6hr,9hr)	Yes (1-2-3-...- 19hr)	Yes (3hr,6hr,9hr)	Yes (1-2-3-...- 19hr)	Yes (3hr,6hr,9hr)	Yes (1-2-3-...- 19hr)	Yes (3hr,6hr,9hr)	Yes (1-2-3-...- 19hr)	Yes (3hr,6hr,9hr)
Eco Wash - Half load option (with 1 mode)	Yes	Yes	Yes	Yes	Yes	Yes	Yes	Yes	Yes
Eco Wash - Half load option (with 3 modes)	-	-	-	-	-	-	-	-	-
Tablet option	-	-	-	-	-	-	-	-	-
Extra Hygiene option	-	-	-	-	-	-	-	-	-
Extra Rinse option	-	-	-	-	-	-	-	-	-
Extra Drying option	-	-	-	-	-	-	-	-	-
Extra Silent option (Silent Wash)	-	-	-	-	-	-	-	-	-
Extra Fast option	-	-	-	-	-	-	-	-	-
Energy Save option	-	-	-	-	-	-	-	-	-
Rinse-aid indicator	Yes	Yes	Yes	Yes	Yes	Yes	Yes	Yes	Yes
Salt indicator	Yes	Yes	Yes	Yes	Yes	Yes	Yes	Yes	Yes
Washing cycle indicators	Yes	Yes	Yes	Yes	Yes	Yes	Yes	Yes	Yes
End of cycle indicator	Yes	Yes	Yes	Yes	Yes	Yes	Yes	Yes	Yes
Child Lock	-	Yes	-	Yes	-	Yes	-	Yes	-
Buzzer	-	-	-	-	-	-	-	-	-
InfoLED	-	-	-	-	-	-	-	-	-
Baskets & Accessories									
3rd basket (Easy Tray)	-	-	-	-	-	-	-	-	-
Adjustable upper basket when empty	Yes	Yes	Yes	Yes	Yes	Yes	Yes	Yes	Yes
Adjustable upper basket when loaded	(o)	(o)	(o)	(o)	(o)	(o)	(o)	(o)	(o)
Number of mug shelves	4 (std)	4 (std)	4 (std)	4 (std)	4 (std)	4 (std)	4 (std)	4 (std)	4 (std)
Mug shelves with soft touch rubber	(o)	(o)	(o)	(o)	(o)	(o)	(o)	(o)	(o)
Foldable racks on upper basket	(o)	(o)	(o)	(o)	(o)	(o)	(o)	(o)	(o)

SPECIFICATIONS

SEMI INTEGRATED - X&T SERIES 45cm Models	X11* 45cm	X1A* 45cm	X12* 45cm	X1B* 45cm	X13 45cm	X1C 45cm	X14* 45cm	X1D* 45cm	X15 45cm
Baskets & Accessories									
Foldable racks on lower basket	(o)	(o)	(o)	(o)	(o)	(o)	(o)	(o)	(o)
Plastic basket handles	(o)	(o)	(o)	(o)	(o)	(o)	(o)	(o)	(o)
Removable cutlery basket (Universal)	Yes	Yes	Yes	Yes	Yes	Yes	Yes	Yes	Yes
Wine glass holder on lower basket	(o) with foldable racks	(o) with foldable racks	(o) with foldable racks	(o) with foldable racks	(o) with foldable racks	(o) with foldable racks	(o) with foldable racks	(o) with foldable racks	(o) with foldable racks
Top nozzle [rotating/fixed]	(Yes) fixed	(Yes) fixed	(Yes) fixed	(Yes) fixed	(Yes) fixed	(Yes) fixed	(Yes) fixed	(Yes) fixed	(Yes) fixed
Aquastop external hose	(o)	(o)	(o)	(o)	(o)	(o)	(o)	(o)	(o)
Antibacterial filter	(o)	(o)	(o)	(o)	(o)	(o)	(o)	(o)	(o)
Interior light	-	-	-	-	-	-	-	-	-
Technical Data (1)									
Noise Level (dB(A))	57/54/52/49/47/45	57/54/52/49/47/45	57/54/52/49/47/45	57/54/52/49/47/45	57/54/52/49/47/45	57/54/52/49/47/45	57/54/52/49/47/45	57/54/52/49/47/45	57/54/52/49/47/45
Energy efficiency class	A++	A++	A++	A++	A++	A++	A++	A++	A++
Cleaning performance	A	A	A	A	A	A	A	A	A
Drying performance	A	A	A	A	A	A	A	A	A
Water consumption (lt)	11	11	11	11	11	11	11	11	11
Annual water consumption (lt/year)	3080	3080	3080	3080	3080	3080	3080	3080	3080
Program duration (min)	198	198	198	198	198	198	198	198	198
Energy consumption (kWh)	0,73	0,73	0,73	0,73	0,73	0,73	0,73	0,73	0,73
Annual energy consumption (kWh/year)	211	211	211	211	211	211	211	211	211
Off mode power consumption (W)	0,50	0,50	0,50	0,50	0,50	0,50	0,50	0,50	0,50
Left-on mode power consumption (W)	1,00	1,00	1,00	1,00	1,00	1,00	1,00	1,00	1,00
Duration of left-on mode (min)	N/A	N/A	N/A	N/A	N/A	N/A	N/A	N/A	N/A
Power rating (W) / Heating element (W)	1900/1800	1900/1800	1900/1800	1900/1800	1900/1800	1900/1800	1900/1800	1900/1800	1900/1800
Plug Type	EU/UK/Swiss /Italy/Israel/AU/NZ/China /Argentina/S.Africa	EU/UK/Swiss /Italy/Israel/AU/NZ/China /Argentina/S.Africa	EU/UK/Swiss /Italy/Israel/AU/NZ/China /Argentina/S.Africa	EU/UK/Swiss /Italy/Israel/AU/NZ/China /Argentina/S.Africa	EU/UK/Swiss /Italy/Israel/AU/NZ/China /Argentina/S.Africa	EU/UK/Swiss /Italy/Israel/AU/NZ/China /Argentina/S.Africa	EU/UK/Swiss /Italy/Israel/AU/NZ/China /Argentina/S.Africa	EU/UK/Swiss /Italy/Israel/AU/NZ/China /Argentina/S.Africa	EU/UK/Swiss /Italy/Israel/AU/NZ/China /Argentina/S.Africa
Power cord length (cm)	180	180	180	180	180	180	180	180	180
Water inlet hose length (cm)	147 (170 for Aquastop ex. hose)	147 (170 for Aquastop ex. hose)	147 (170 for Aquastop ex. hose)	147 (170 for Aquastop ex. hose)	147 (170 for Aquastop ex. hose)	147 (170 for Aquastop ex. hose)	147 (170 for Aquastop ex. hose)	147 (170 for Aquastop ex. hose)	147 (170 for Aquastop ex. hose)
Water outlet hose length (cm)	200	200	200	200	200	200	200	200	200
Voltage (V) / Frequency (Hz) / Fuse Rating (A)	220-240 / 50/10	220-240 / 50/10	220-240 / 50/10	220-240 / 50/10	220-240 / 50/10	220-240 / 50/10	220-240 / 50/10	220-240 / 50/10	220-240 / 50/10
Dimensions									
Height (cm)	82,0	82,0	82,0	82,0	82,0	82,0	82,0	82,0	82,0
Width (cm)	45,0	45,0	45,0	45,0	45,0	45,0	45,0	45,0	45,0
Depth (cm)	57,0	57,0	57,0	57,0	57,0	57,0	57,0	57,0	57,0
Height adjustment (+cm)	5	5	5	5	5	5	5	5	5
Adjustable Plinth for undertable usage (mm)	-	-	-	-	-	-	-	-	-
Possible adjustment of the plinth (horizontal/vertical) (mm/mm)	-	-	-	-	-	-	-	-	-
Height without worktop (cm)	-	-	-	-	-	-	-	-	-
Packed dimensions (Height x Width x Depth) (cm)	86.1 x 49.4 x 66.1	86.1 x 49.4 x 66.1	86.1 x 49.4 x 66.1	86.1 x 49.4 x 66.1	86.1 x 49.4 x 66.1	86.1 x 49.4 x 66.1	86.1 x 49.4 x 66.1	86.1 x 49.4 x 66.1	86.1 x 49.4 x 66.1
Stacking quantity (pcs)	5	5	5	5	5	5	5	5	5
Gross/Net weight (kg) (2)	34/32	34/32	34/32	34/32	34/32	34/32	34/32	34/32	34/32
Container loading (40"HC/40"/20")	216/144/72	216/144/72	216/144/72	216/144/72	216/144/72	216/144/72	216/144/72	216/144/72	216/144/72

SPECIFICATIONS

SEMI INTEGRATED - X&T SERIES 45cm Models	X1E 45cm	X16* 45cm	X1F* 45cm	T14 45cm	T15 45cm	T21 45cm	T22 45cm	T24 45cm
General Characteristics								
Number of place settings (PS)	10	10	10	10	10	10	10	10
Number of programs	6	7	7	7	7	8+	8+	8+
Temperatures (°C)	40-50-65-70	40-50-65-70	40-50-65-70	40-50-65-70	40-50-65-70	Auto-30-40-50-60-65-70	Auto-30-40-50-60-65-70	Auto-30-40-50-60-65-70
Control type	full-electronic	full-electronic	full-electronic	full-electronic	full-electronic	full-electronic	full-electronic	full-electronic
Hidden heating element	Yes	Yes	Yes	Yes	Yes	Yes	Yes	Yes
Filter type	Metal	Metal	Metal	Metal	Metal	Metal	Metal	Metal
Tub material	Stainless Steel	Stainless Steel	Stainless Steel	Stainless Steel	Stainless Steel	Stainless Steel	Stainless Steel	Stainless Steel
Turbidity sensor (Smart Wash)	-	-	-	-	-	Yes	Yes	Yes
Drying system	Mini Active/Super Active	Mini Active/Super Active	Mini Active/Super Active	Mini Active/Super Active	Mini Active/Super Active	Mini Active/Super Active	Turbo	Turbo
Divisor system	-	-	-	-	-	Yes	Yes	Yes
Overflow & leakage protection	Yes	Yes	Yes	Yes	Yes	Yes	Yes	Yes
Heater protection	Yes	Yes	Yes	Yes	Yes	Yes	Yes	Yes
Circulation pump	Asynchronous	Asynchronous	Asynchronous	Asynchronous	Asynchronous	Asynchronous	Asynchronous	BLDC
Auto Door	-	-	-	-	-	-	-	Yes
Water Box	-	-	-	-	-	-	-	-
Triple & Direct Wash	-	-	-	-	-	-	-	-
Wi-fi	-	-	-	-	-	-	-	-
Available Aesthetics	Orchis	Orchis	Orchis	Vento	Vento	Vento	Vento	Vento
Programs								
Prewash	Yes	Yes	Yes	Yes	Yes	Yes	Yes	Yes
Mini 18' (Jet Wash)	-	-	-	-	-	-	-	-
Quick 30' 40°C	Yes	Yes	Yes	Yes	Yes	Yes	Yes	Yes
Eco	Yes	Yes	Yes	Yes	Yes	Yes	Yes	Yes
Super 50' 65°C (Quick Clean)	Yes	Yes	Yes	Yes	Yes	Yes	Yes	Yes
Super 55' 60°C	-	-	-	-	-	-	-	-
Delicate 40°C	-	Yes	Yes	Yes	Yes	-	-	-
Normal 55°C	-	-	-	-	-	-	-	-
Daily 60°C	-	-	-	-	-	-	-	-
Dual Pro Wash 60°C	-	-	-	-	-	-	-	Yes
Hygiene 60°C	-	-	-	-	-	-	-	-
Hygiene 70°C	Yes	Yes	Yes	Yes	Yes	Yes	Yes	Yes
Intensive 65°C	Yes	Yes	Yes	Yes	Yes	-	-	-
Intensive 70°C	-	-	-	-	-	-	-	-
Auto Delicate 30°C - 50°C	-	-	-	-	-	Yes	Yes	Yes
Auto Normal 50°C - 60°C	-	-	-	-	-	Yes	Yes	-
Auto Intensive 60°C - 70°C	-	-	-	-	-	Yes	Yes	Yes (50°C - 70°C)
Extra Intensive 70°C (Prewash Button + Intensive 65°C)	-	-	-	-	-	-	-	-
Extra Hygiene 70°C (Prewash Button + Hygiene 60°C)	-	-	-	-	-	-	-	-
Steam Wash	-	-	-	-	-	-	-	-
Eco 5.4 lt	-	-	-	-	-	-	-	-
User Interface								
Start/Pause button	Yes	Yes	Yes	Yes	Yes	Yes	Yes	Yes
DISPLAY (delay start, remaining time)	Yes: LED	-	Yes: LED	Yes: LED	-	Yes: LED	Yes: LED	Yes: LED
Prewash button	-	-	-	-	-	-	-	-
Program selection button	Knob	Knob	Knob	Yes	Yes	Yes	Yes	Yes
Delay timer option	Yes (1-2-3-...-19hr)	Yes (3hr,6hr,9hr)	Yes (1-2-3-...-19hr)	Yes (1-2-3-...-24hr)	Yes (3hr,6hr,9hr)	Yes (1-2-3-...-24hr)	Yes (1-2-3-...-24hr)	Yes (1-2-3-...-24hr)
Eco Wash - Half load option (with 1 mode)	Yes	Yes	Yes	Yes	-	-	-	-
Eco Wash - Half load option (with 3 modes)	-	-	-	-	-	Yes	Yes	Yes
Tablet option	-	-	-	Yes	-	Yes	Yes	-
Extra Hygiene option	-	-	-	-	-	-	-	-
Extra Rinse option	-	-	-	Yes	-	Yes	Yes	-
Extra Drying option	-	-	-	-	-	Yes	Yes	-
Extra Silent option (Silent Wash)	-	-	-	-	-	-	-	Yes
Extra Fast option	-	-	-	-	-	-	-	Yes
Energy Save option	-	-	-	-	-	-	-	Yes
Rinse-aid indicator	Yes	Yes	Yes	Yes	Yes	Yes	Yes	Yes
Salt indicator	Yes	Yes	Yes	Yes	Yes	Yes	Yes	Yes
Washing cycle indicators	Yes	Yes	Yes	Yes	Yes	Yes	Yes	Yes
End of cycle indicator	Yes	Yes	Yes	Yes	Yes	Yes	Yes	Yes
Child Lock	Yes	-	Yes	Yes	-	Yes	Yes	Yes
Buzzer	-	-	-	-	-	-	-	-
InfoLED	-	-	-	-	-	-	-	-
Baskets & Accessories								
3rd basket (Easy Tray)	-	-	-	-	-	-	(o)	Yes
Adjustable upper basket when empty	Yes	Yes	Yes	Yes	Yes	Yes	Yes	Yes
Adjustable upper basket when loaded	(o)	(o)	(o)	(o)	(o)	(o)	(o)	(o)
Number of mug shelves	4 (std)	4 (std)	4 (std)	4 (std)	4 (std)	4 (std)	4 (std)	4 (std)
Mug shelves with soft touch rubber	(o)	(o)	(o)	(o)	(o)	(o)	(o)	(o)
Foldable racks on upper basket	(o)	(o)	(o)	(o)	(o)	(o)	(o)	(o)

SPECIFICATIONS

SEMI INTEGRATED - X&T SERIES 45cm Models	X1E 45cm	X16* 45cm	X1F* 45cm	T14 45cm	T15 45cm	T21 45cm	T22 45cm	T24 45cm
Baskets & Accessories								
Foldable racks on lower basket	(o)	(o)	(o)	(o)	(o)	(o)	(o)	(o)
Plastic basket handles	(o)	(o)	(o)	(o)	(o)	(o)	(o)	Yes
Removable cutlery basket (Universal)	Yes	Yes	Yes	Yes	Yes	Yes	(Yes) with 2 baskets/ (o) with 3rd basket	(o)
Wine glass holder on lower basket	(o) with foldable racks	(o) with foldable racks	(o) with foldable racks	(o) with foldable racks	(o) with foldable racks	(o) with foldable racks	(o) with foldable racks	(o) with foldable racks
Top nozzle [rotating/ fixed]	(Yes) fixed	(Yes) fixed	(Yes) fixed	(Yes) fixed	(Yes) fixed	(Yes) fixed	(Yes) fixed with 2 baskets/rotating with 3rd basket	(Yes) rotating
Aquastop external hose	(o)	(o)	(o)	(o)	(o)	(o)	(o)	(o)
Antibacterial filter	(o)	(o)	(o)	(o)	(o)	(o)	(o)	(o)
Interior light	-	-	-	-	-	(o)	(o)	(o)
Technical Data (1)								
Noise Level (dB(A))	57/54/52/49/47/45	57/54/52/49/47/45	57/54/52/49/47/45	57/54/52/49/47/45	57/54/52/49/47/45	54/52/49/47/45	52/49/47/45	44
Energy efficiency class	A++	A++	A++	A++	A++	A++	A++	A+++
Cleaning performance	A	A	A	A	A	A	A	A
Drying performance	A	A	A	A	A	A	A	A
Water consumption (lt)	11	11	11	11	11	9	9	9
Annual water consumption (lt/year)	3080	3080	3080	3080	3080	2520	2520	2520
Program duration (min)	198	198	198	198	198	198	198	185
Energy consumption (kWh)	0,73	0,73	0,73	0,73	0,73	0,73	0,73	0,65
Annual energy consumption (kWh/year)	211	211	211	211	211	211	211	188
Off mode power consumption (W)	0,50	0,50	0,50	0,50	0,50	0,50	0,50	0,50
Left-on mode power consumption (W)	1,00	1,00	1,00	1,00	1,00	1,00	1,00	1,00
Duration of left-on mode (min)	N/A	N/A	N/A	N/A	N/A	N/A	N/A	N/A
Power rating (W) / Heating element (W)	1900/1800	1900/1800	1900/1800	1900/1800	1900/1800	1900/1800	1900/1800	1900/1800
Plug Type	EU/UK/Swiss /Italy/Israel/ AU/NZ/China /Argentina/ S.Africa	EU/UK/Swiss /Italy/Israel/ AU/NZ/China /Argentina/ S.Africa	EU/UK/Swiss /Italy/Israel/ AU/NZ/China /Argentina/ S.Africa	EU/UK/Swiss /Italy/Israel/ AU/NZ/China /Argentina/ S.Africa	EU/UK/Swiss /Italy/Israel/ AU/NZ/China /Argentina/ S.Africa	EU/UK/Swiss /Italy/Israel/ AU/NZ/China /Argentina/ S.Africa	EU/UK/Swiss /Italy/Israel/ AU/NZ/China /Argentina/ S.Africa	EU/UK/Swiss /Italy/Israel/ AU/NZ/China /Argentina/ S.Africa
Power cord length (cm)	180	180	180	180	180	180	180	180
Water inlet hose length (cm)	147 (170 for Aquastop ex. hose)	147 (170 for Aquastop ex. hose)	147 (170 for Aquastop ex. hose)	147 (170 for Aquastop ex. hose)	147 (170 for Aquastop ex. hose)	147 (170 for Aquastop ex. hose)	147 (170 for Aquastop ex. hose)	147 (170 for Aquastop ex. hose)
Water outlet hose length (cm)	200	200	200	200	200	200	200	200
Voltage (V) / Frequency (Hz) / Fuse Rating (A)	220-240/50/10	220-240/50/10	220-240/50/10	220-240/50/10	220-240/50/10	220-240/50/10	220-240/50/10	220-240/50/10
Dimensions								
Height (cm)	82,0	82,0	82,0	82,0	82,0	82,0	82,0	82,0
Width (cm)	45,0	45,0	45,0	45,0	45,0	45,0	45,0	45,0
Depth (cm)	57,0	57,0	57,0	57,0	57,0	57,0	57,0	57,0
Height adjustment (+cm)	5	5	5	5	5	5	5	5
Adjustable Plinth for undertable usage (mm)	-	-	-	-	-	-	-	-
Possible adjustment of the plinth (horizontal/vertical) (mm/mm)	-	-	-	-	-	-	-	-
Height without worktop (cm)	-	-	-	-	-	-	-	-
Packed dimensions (Height x Width x Depth) (cm)	86.1 x 49.4 x 66.1	86.1 x 49.4 x 66.1	86.1 x 49.4 x 66.1	86.1 x 49.4 x 66.1	86.1 x 49.4 x 66.1	86.1 x 49.4 x 66.1	86.1 x 49.4 x 66.1	86.1 x 49.4 x 66.1
Stacking quantity (pcs)	5	5	5	5	5	5	5	5
Gross/Net weight (kg) (2)	34/32	34/32	34/32	34/32	34/32	34/32	34/32	34/32
Container loading (40"HC/40"/20")	216/144/72	216/144/72	216/144/72	216/144/72	216/144/72	216/144/72	216/144/72	216/144/72

Notes

(o) : Optional

(*) : These models will be available on August 2018

(1) : Based on the tests performed with Eco programme in accordance with European Household Dishwasher Performance Standards

(2) : Gross/Net Weights are shown as reference in the table. It should be calculated based on the final product features created from this general spect table.

SPECIFICATIONS

SEMI INTEGRATED - Y SERIES 45cm Models	Y11* 45cm	Y1A* 45cm	Y12* 45cm	Y1B* 45cm	Y13 45cm	Y1C 45cm	Y14* 45cm	Y1D* 45cm
General Characteristics								
Number of place settings (PS)	10	10	10	10	10	10	10	10
Number of programs	2	2	3	3	4	4	5	5
Temperatures (°C)	50-65	50-65	50-65	50-65	40-50-65	40-50-65	40-50-65	40-50-65
Control type	full-electronic	full-electronic	full-electronic	full-electronic	full-electronic	full-electronic	full-electronic	full-electronic
Hidden heating element	Yes	Yes	Yes	Yes	Yes	Yes	Yes	Yes
Filter type	Metal	Metal	Metal	Metal	Metal	Metal	Metal	Metal
Tub material	Stainless Steel	Stainless Steel	Stainless Steel	Stainless Steel	Stainless Steel	Stainless Steel	Stainless Steel	Stainless Steel
Turbidity sensor (Smart Wash)	-	-	-	-	-	-	-	-
Drying system	Mini Active/ Super Active	Mini Active/ Super Active	Mini Active/ Super Active	Mini Active/ Super Active	Mini Active/ Super Active	Mini Active/ Super Active	Mini Active/ Super Active	Mini Active/ Super Active
Divisor system	-	-	-	-	-	-	-	-
Overflow & leakage protection	Yes	Yes	Yes	Yes	Yes	Yes	Yes	Yes
Heater protection	Yes	Yes	Yes	Yes	Yes	Yes	Yes	Yes
Circulation pump	Asynchronous	Asynchronous	Asynchronous	Asynchronous	Asynchronous	Asynchronous	Asynchronous	Asynchronous
Auto Door	-	-	-	-	-	-	-	-
Water Box	-	-	-	-	-	-	-	-
Triple & Direct Wash	-	-	-	-	-	-	-	-
Wi-fi	-	-	-	-	-	-	-	-
Available Aesthetics	Klikya Y, Lydia Y	Klikya Y, Lydia Y	Klikya Y, Lydia Y	Klikya Y, Lydia Y	Klikya Y, Lydia Y	Klikya Y, Lydia Y	Klikya Y, Lydia Y	Klikya Y, Lydia Y
Programs								
Prewash	-	-	-	-	-	-	-	-
Mini 18' (Jet Wash)	-	-	-	-	-	-	-	-
Quick 30' 40°C	-	-	-	-	Yes	Yes	Yes	Yes
Eco	Yes	Yes	Yes	Yes	Yes	Yes	Yes	Yes
Super 50' 65°C (Quick Clean)	-	-	Yes	Yes	Yes	Yes	Yes	Yes
Super 55' 60°C	-	-	-	-	-	-	-	-
Delicate 40°C	-	-	-	-	-	-	Yes	Yes
Normal 55°C	-	-	-	-	-	-	-	-
Daily 60°C	-	-	-	-	-	-	-	-
Dual Pro Wash 60°C	-	-	-	-	-	-	-	-
Hygiene 60°C	-	-	-	-	-	-	-	-
Hygiene 70°C	-	-	-	-	-	-	-	-
Intensive 65°C	Yes	Yes	Yes	Yes	Yes	Yes	Yes	Yes
Intensive 70°C	-	-	-	-	-	-	-	-
Auto Delicate 30°C - 50°C	-	-	-	-	-	-	-	-
Auto Normal 50°C - 60°C	-	-	-	-	-	-	-	-
Auto Intensive 60°C - 70°C	-	-	-	-	-	-	-	-
Extra Intensive 70°C (Prewash Button + Intensive 65°C)	-	-	-	-	-	-	-	-
Extra Hygiene 70°C (Prewash Button + Hygiene 60°C)	-	-	-	-	-	-	-	-
Steam Wash	-	-	-	-	-	-	-	-
Eco 5.4 lt	-	-	-	-	-	-	-	-
User Interface								
Start/Pause button	Yes	Yes	Yes	Yes	Yes	Yes	Yes	Yes
DISPLAY (delay start, remaining time)	-	Yes: LED	-	Yes: LED	-	Yes: LED	-	Yes: LED
Prewash button	-	-	-	-	-	-	-	-
Program selection button	Yes	Yes	Yes	Yes	Yes	Yes	Yes	Yes
Delay timer option	Yes (3hr,6hr,9hr)	Yes (1-2-3-...-19hr)	Yes (3hr,6hr,9hr)	Yes (1-2-3-...-19hr)	Yes (3hr,6hr,9hr)	Yes (1-2-3-...-19hr)	Yes (3hr,6hr,9hr)	Yes (1-2-3-...-19hr)
Eco Wash - Half load option (with 1 mode)	Yes	Yes	Yes	Yes	Yes	Yes	Yes	Yes
Eco Wash - Half load option (with 3 modes)	-	-	-	-	-	-	-	-
Tablet option	-	Yes	-	Yes	-	Yes	-	Yes
Extra Hygiene option	-	Yes	-	Yes	-	Yes	-	Yes
Extra Rinse option	-	Yes	-	Yes	-	Yes	-	Yes
Extra Drying option	-	Yes	-	Yes	-	Yes	-	Yes
Extra Silent option (Silent Wash)	-	-	-	-	-	-	-	-
Extra Fast option	-	-	-	-	-	-	-	-
Energy Save option	-	-	-	-	-	-	-	-
Rinse-aid indicator	Yes	Yes	Yes	Yes	Yes	Yes	Yes	Yes
Salt indicator	Yes	Yes	Yes	Yes	Yes	Yes	Yes	Yes
Washing cycle indicators	Yes	Yes	Yes	Yes	Yes	Yes	Yes	Yes
End of cycle indicator	Yes	Yes	Yes	Yes	Yes	Yes	Yes	Yes
Child Lock	-	Yes	-	Yes	-	Yes	-	Yes
Buzzer	-	-	-	-	-	-	-	-
InfoLED	-	-	-	-	-	-	-	-
Baskets & Accessories								
3rd basket (Easy Tray)	-	-	-	-	-	-	-	-
Adjustable upper basket when empty	Yes	Yes	Yes	Yes	Yes	Yes	Yes	Yes
Adjustable upper basket when loaded	(o)	(o)	(o)	(o)	(o)	(o)	(o)	(o)
Number of mug shelves	4 (std)	4 (std)	4 (std)	4 (std)	4 (std)	4 (std)	4 (std)	4 (std)
Mug shelves with soft touch rubber	(o)	(o)	(o)	(o)	(o)	(o)	(o)	(o)
Foldable racks on upper basket	(o)	(o)	(o)	(o)	(o)	(o)	(o)	(o)

SPECIFICATIONS

SEMI INTEGRATED - Y SERIES 45cm Models	Y11* 45cm	Y1A* 45cm	Y12* 45cm	Y1B* 45cm	Y13 45cm	Y1C 45cm	Y14* 45cm	Y1D* 45cm
Baskets & Accessories								
Foldable racks on lower basket	(o)	(o)	(o)	(o)	(o)	(o)	(o)	(o)
Plastic basket handles	(o)	(o)	(o)	(o)	(o)	(o)	(o)	(o)
Removable cutlery basket (Universal)	Yes	Yes	Yes	Yes	Yes	Yes	Yes	Yes
Wine glass holder on lower basket	(o) with foldable racks	(o) with foldable racks	(o) with foldable racks	(o) with foldable racks	(o) with foldable racks	(o) with foldable racks	(o) with foldable racks	(o) with foldable racks
Top nozzle [rotating/ fixed]	(Yes) fixed	(Yes) fixed	(Yes) fixed	(Yes) fixed	(Yes) fixed	(Yes) fixed	(Yes) fixed	(Yes) fixed
Aquastop external hose	(o)	(o)	(o)	(o)	(o)	(o)	(o)	(o)
Antibacterial filter	(o)	(o)	(o)	(o)	(o)	(o)	(o)	(o)
Interior light	-	-	-	-	-	-	-	-
Technical Data (2)								
Noise Level (dB(A))	57/54/52/49/47/45	57/54/52/49/47/45	57/54/52/49/47/45	57/54/52/49/47/45	57/54/52/49/47/45	57/54/52/49/47/45	57/54/52/49/47/45	57/54/52/49/47/45
Energy efficiency class	A++	A++	A++	A++	A++	A++	A++	A++
Cleaning performance	A	A	A	A	A	A	A	A
Drying performance	A	A	A	A	A	A	A	A
Water consumption (lt)	11	11	11	11	11	11	11	11
Annual water consumption (lt/year)	3080	3080	3080	3080	3080	3080	3080	3080
Program duration (min)	198	198	198	198	198	198	198	198
Energy consumption (kWh)	0,73	0,73	0,73	0,73	0,73	0,73	0,73	0,73
Annual energy consumption (kWh/year)	211	211	211	211	211	211	211	211
Off mode power consumption (W)	0,50	0,50	0,50	0,50	0,50	0,50	0,50	0,50
Left-on mode power consumption (W)	1,00	1,00	1,00	1,00	1,00	1,00	1,00	1,00
Duration of left-on mode (min)	N/A	N/A	N/A	N/A	N/A	N/A	N/A	N/A
Power rating (W) / Heating element (W)	1900/1800	1900/1800	1900/1800	1900/1800	1900/1800	1900/1800	1900/1800	1900/1800
Plug Type	EU/UK/Swiss /Italy/Israel/ AU/NZ/China /Argentina/ S.Africa	EU/UK/Swiss /Italy/Israel/ AU/NZ/China /Argentina/ S.Africa	EU/UK/Swiss /Italy/Israel/ AU/NZ/China /Argentina/ S.Africa	EU/UK/Swiss /Italy/Israel/ AU/NZ/China /Argentina/ S.Africa	EU/UK/Swiss /Italy/Israel/ AU/NZ/China /Argentina/ S.Africa	EU/UK/Swiss /Italy/Israel/ AU/NZ/China /Argentina/ S.Africa	EU/UK/Swiss /Italy/Israel/ AU/NZ/China /Argentina/ S.Africa	EU/UK/Swiss /Italy/Israel/ AU/NZ/China /Argentina/ S.Africa
Power cord length (cm)	180	180	180	180	180	180	180	180
Water inlet hose length (cm)	147 (170 for Aquastop ex. hose)	147 (170 for Aquastop ex. hose)	147 (170 for Aquastop ex. hose)	147 (170 for Aquastop ex. hose)	147 (170 for Aquastop ex. hose)	147 (170 for Aquastop ex. hose)	147 (170 for Aquastop ex. hose)	147 (170 for Aquastop ex. hose)
Water outlet hose length (cm)	200	200	200	200	200	200	200	200
Voltage (V) / Frequency (Hz) / Fuse Rating (A)	220-240 / 50/10	220-240 / 50/10	220-240 / 50/10	220-240 / 50/10	220-240 / 50/10	220-240 / 50/10	220-240 / 50/10	220-240 / 50/10
Dimensions								
Height (cm)	82,0	82,0	82,0	82,0	82,0	82,0	82,0	82,0
Width (cm)	45,0	45,0	45,0	45,0	45,0	45,0	45,0	45,0
Depth (cm)	57,0	57,0	57,0	57,0	57,0	57,0	57,0	57,0
Height adjustment (+cm)	5	5	5	5	5	5	5	5
Adjustable Plinth for undertable usage (mm)	-	-	-	-	-	-	-	-
Possible adjustment of the plinth (horizontal/ vertical) (mm / mm)	-	-	-	-	-	-	-	-
Height without worktop (cm)	-	-	-	-	-	-	-	-
Packed dimensions (Height x Width x Depth) (cm)	86.1 x 49.4 x 66.1	86.1 x 49.4 x 66.1	86.1 x 49.4 x 66.1	86.1 x 49.4 x 66.1	86.1 x 49.4 x 66.1	86.1 x 49.4 x 66.1	86.1 x 49.4 x 66.1	86.1 x 49.4 x 66.1
Stacking quantity (pcs)	5	5	5	5	5	5	5	5
Gross/Net weight (kg) (3)	34/32	34/32	34/32	34/32	34/32	34/32	34/32	34/32
Container loading (40"HC/ 40"/ 20")	216/144/72	216/144/72	216/144/72	216/144/72	216/144/72	216/144/72	216/144/72	216/144/72

(o) : Optional

(*) : These models will be available on December 2018

(1) : Based on the tests performed with Eco programme in accordance with European Household Dishwasher Performance Standards

(2) : Gross/Net Weights are shown as reference in the table. It should be calculated based on the final product features created from this general spect table.

SPECIFICATIONS

SEMI INTEGRATED - Y SERIES 45cm Models	Y15 45cm	Y1E 45cm	Y1F* 45cm	Y21* 45cm	Y22* 45cm	Y23* 45cm	Y24* 45cm	Y25* 45cm
General Characteristics								
Number of place settings (PS)	10	10	10	10	10	10	10	10
Number of programs	6	6	7	6	7	8	9+	9+
Temperatures (°C)	40-50-65	40-50-65	40-50-60-65	40-50-65	40-50-60-65	40-50-60-65	Auto-30-40-50-60-65-70	Auto-30-40-50-60-65-70
Control type	full-electronic	full-electronic	full-electronic	full-electronic	full-electronic	full-electronic	full-electronic	full-electronic
Hidden heating element	Yes	Yes	Yes	Yes	Yes	Yes	Yes	Yes
Filter type	Metal	Metal	Metal	Metal	Metal	Metal	Metal	Metal
Tub material	Stainless Steel	Stainless Steel	Stainless Steel	Stainless Steel	Stainless Steel	Stainless Steel	Stainless Steel	Stainless Steel
Turbidity sensor (Smart Wash)	-	-	-	-	-	-	Yes	Yes
Drying system	Mini Active/ Super Active	Mini Active/ Super Active	Mini Active/ Super Active	Mini Active/ Super Active/ Turbo(1)	Mini Active/ Super Active/ Turbo(1)	Mini Active/ Super Active/ Turbo(1)	Mini Active/ Super Active/ Turbo(1)	Turbo
Divisor system	-	-	-	Yes	Yes	Yes	Yes	Yes
Overflow & leakage protection	Yes	Yes	Yes	Yes	Yes	Yes	Yes	Yes
Heater protection	Yes	Yes	Yes	Yes	Yes	Yes	Yes	Yes
Circulation pump	Asynchronous	Asynchronous	Asynchronous	Asynchronous	Asynchronous	Asynchronous	Asynchronous	BLDC
Auto Door	-	-	-	-	-	-	-	Yes
Water Box	-	-	-	-	-	-	-	-
Triple & Direct Wash	-	-	-	-	-	-	-	-
Wi-fi	-	-	-	-	-	-	-	-
Available Aesthetics	Klikya Y, Lydia Y	Klikya Y, Lydia Y	Klikya Y, Lydia Y	Klikya Y, Lydia Y	Klikya Y, Lydia Y	Klikya Y, Lydia Y	Klikya Y, Lydia Y	Klikya Y, Lydia Y
Programs								
Prewash	Yes	Yes	Yes	Yes	Yes	Yes	Yes	Yes
Mini 18' (Jet Wash)	-	-	-	-	-	-	-	Yes
Quick 30' 40°C	Yes	Yes	Yes	Yes	Yes	Yes	Yes	Yes
Eco	Yes	Yes	Yes	Yes	Yes	Yes	Yes	Yes
Super 50' 65°C (Quick Clean)	Yes	Yes	Yes	Yes	Yes	Yes	Yes	Yes
Super 55' 60°C	-	-	-	-	-	-	-	-
Delicate 40°C	Yes	Yes	Yes	Yes	Yes	Yes	-	-
Normal 55°C	-	-	-	-	-	Yes	-	-
Daily 60°C	-	-	Yes	-	Yes	Yes	Yes	-
Dual Pro Wash 60°C	-	-	-	-	-	-	-	Yes
Hygiene 60°C	-	-	-	-	-	-	-	-
Hygiene 70°C	-	-	-	-	-	-	-	Yes
Intensive 65°C	Yes	Yes	Yes	Yes	Yes	Yes	-	-
Intensive 70°C	-	-	-	-	-	-	-	-
Auto Delicate 30°C - 50°C	-	-	-	-	-	-	Yes	-
Auto Normal 50°C - 60°C	-	-	-	-	-	-	Yes	-
Auto Intensive 60°C - 70°C	-	-	-	-	-	-	Yes	Yes
Extra Intensive 70°C (Prewash Button + Intensive 65°C)	-	-	-	-	-	-	-	-
Extra Hygiene 70°C (Prewash Button + Hygiene 60°C)	-	-	-	-	-	-	-	-
Steam Wash	-	-	-	-	-	-	Yes	Yes
Eco 5.4 lt	-	-	-	-	-	-	-	-
User Interface								
Start/Pause button	Yes	Yes	Yes	Yes	Yes	Yes	Yes	Yes
DISPLAY (delay start, remaining time)	-	Yes: LED	Yes: LED	Yes: LED	Yes: LED	Yes: LED	Yes: LED	Yes: LED
Prewash button	-	-	-	-	-	-	-	-
Program selection button	Yes	Yes	Yes	Yes	Yes	Yes	Yes	Yes
Delay timer option	Yes (3hr,6hr,9hr)	Yes (1-2-3-...-19hr)	Yes (1-2-3-...-19hr)	Yes (1-2-3-...-19hr)	Yes (1-2-3-...-19hr)	Yes (1-2-3-...-19hr)	Yes (1-2-3-...-19hr)	Yes (1-2-3-...-19hr)
Eco Wash - Half load option (with 1 mode)	Yes	Yes	Yes	-	-	-	-	-
Eco Wash - Half load option (with 3 modes)	-	-	-	Yes	Yes	Yes	Yes	Yes
Tablet option	-	Yes	Yes	Yes	Yes	Yes	Yes	Yes
Extra Hygiene option	-	Yes	Yes	Yes	Yes	Yes	Yes	-
Extra Rinse option	-	Yes	Yes	Yes	Yes	Yes	Yes	-
Extra Drying option	-	Yes	Yes	Yes	Yes	Yes	Yes	-
Extra Silent option (Silent Wash)	-	-	-	-	-	-	-	Yes
Extra Fast option	-	-	-	-	-	-	-	Yes
Energy Save option	-	-	-	-	-	-	-	Yes
Rinse-aid indicator	Yes	Yes	Yes	Yes	Yes	Yes	Yes	Yes
Salt indicator	Yes	Yes	Yes	Yes	Yes	Yes	Yes	Yes
Washing cycle indicators	Yes	Yes	Yes	Yes	Yes	Yes	Yes	Yes
End of cycle indicator	Yes	Yes	Yes	Yes	Yes	Yes	Yes	Yes
Child Lock	-	Yes	Yes	Yes	Yes	Yes	Yes	Yes
Buzzer	-	-	-	-	-	-	-	-
InfoLED	-	-	-	-	-	-	-	-
Baskets & Accessories								
3rd basket (Easy Tray)	-	-	-	(o)	(o)	(o)	(o)	Yes
Adjustable upper basket when empty	Yes	Yes	Yes	Yes	Yes	Yes	Yes	Yes
Adjustable upper basket when loaded	(o)	(o)	(o)	(o)	(o)	(o)	(o)	(o)
Number of mug shelves	4 (std)	4 (std)	4 (std)	4 (std)	4 (std)	4 (std)	4 (std)	4 (std)
Mug shelves with soft touch rubber	(o)	(o)	(o)	(o)	(o)	(o)	(o)	(o)

SPECIFICATIONS

SEMI INTEGRATED - Y SERIES 45cm Models	Y15 45cm	Y1E 45cm	Y1F* 45cm	Y21* 45cm	Y22* 45cm	Y23* 45cm	Y24* 45cm	Y25* 45cm
Baskets & Accessories								
Foldable racks on upper basket	(o)	(o)	(o)	(o)	(o)	(o)	(o)	(o)
Foldable racks on lower basket	(o)	(o)	(o)	(o)	(o)	(o)	(o)	(o)
Plastic basket handles	(o)	(o)	(o)	(o)	(o)	(o)	(o)	Yes
Removable cutlery basket (Universal)	Yes	Yes	Yes	(Yes) with 2 baskets/ (o) with 3rd basket	(Yes) with 2 baskets/ (o) with 3rd basket	(Yes) with 2 baskets/ (o) with 3rd basket	(Yes) with 2 baskets/ (o) with 3rd basket	(o)
Wine glass holder on lower basket	(o) with foldable racks	(o) with foldable racks	(o) with foldable racks	(o) with foldable racks	(o) with foldable racks	(o) with foldable racks	(o) with foldable racks	(o) with foldable racks
Top nozzle [rotating/ fixed]	(Yes) fixed	(Yes) fixed	(Yes) fixed	(Yes) fixed with 2 baskets/ rotating with 3rd basket	(Yes) fixed with 2 baskets/ rotating with 3rd basket	(Yes) fixed with 2 baskets/ rotating with 3rd basket	(Yes) fixed with 2 baskets/ rotating with 3rd basket	(Yes) rotating
Aquastop external hose	(o)	(o)	(o)	(o)	(o)	(o)	(o)	(o)
Antibacterial filter	(o)	(o)	(o)	(o)	(o)	(o)	(o)	(o)
Interior light	-	-	-	(o)	(o)	(o)	(o)	(o)
Technical Data (2)								
Noise Level (dB(A))	57/54/52/49/47/45	57/54/52/49/47/45	57/54/52/49/47/45	54/52/49/47/45	54/52/49/47/45	54/52/49/47/45	54/52/49/47/45	44
Energy efficiency class	A++	A++	A++	A++	A++	A++	A++	A+++
Cleaning performance	A	A	A	A	A	A	A	A
Drying performance	A	A	A	A	A	A	A	A
Water consumption (lt)	11	11	11	9	9	9	9	9
Annual water consumption (lt/year)	3080	3080	3080	2520	2520	2520	2520	2520
Program duration (min)	198	198	198	198	198	198	198	185
Energy consumption (kWh)	0,73	0,73	0,73	0,73	0,73	0,73	0,73	0,65
Annual energy consumption (kWh/year)	211	211	211	211	211	211	211	188
Off mode power consumption (W)	0,50	0,50	0,50	0,50	0,50	0,50	0,50	0,50
Left-on mode power consumption (W)	1,00	1,00	1,00	1,00	1,00	1,00	1,00	1,00
Duration of left-on mode (min)	N/A	N/A	N/A	N/A	N/A	N/A	N/A	N/A
Power rating (W) / Heating element (W)	1900/1800	1900/1800	1900/1800	1900/1800	1900/1800	1900/1800	1900/1800	1900/1800
Plug Type	EU/UK/Swiss /Italy/Israel/AU/NZ/China /Argentina/ S.Africa	EU/UK/Swiss /Italy/Israel/AU/NZ/China /Argentina/ S.Africa	EU/UK/Swiss /Italy/Israel/AU/NZ/China /Argentina/ S.Africa	EU/UK/Swiss /Italy/Israel/AU/NZ/China /Argentina/ S.Africa	EU/UK/Swiss /Italy/Israel/AU/NZ/China /Argentina/ S.Africa	EU/UK/Swiss /Italy/Israel/AU/NZ/China /Argentina/ S.Africa	EU/UK/Swiss /Italy/Israel/AU/NZ/China /Argentina/ S.Africa	EU/UK/Swiss /Italy/Israel/AU/NZ/China /Argentina/ S.Africa
Power cord length (cm)	180	180	180	180	180	180	180	180
Water inlet hose length (cm)	147 (170 for Aquastop ex. hose)	147 (170 for Aquastop ex. hose)	147 (170 for Aquastop ex. hose)	147 (170 for Aquastop ex. hose)	147 (170 for Aquastop ex. hose)	147 (170 for Aquastop ex. hose)	147 (170 for Aquastop ex. hose)	147 (170 for Aquastop ex. hose)
Water outlet hose length (cm)	200	200	200	200	200	200	200	200
Voltage (V) / Frequency (Hz) / Fuse Rating (A)	220-240 / 50 / 10	220-240 / 50 / 10	220-240 / 50 / 10	220-240 / 50 / 10	220-240 / 50 / 10	220-240 / 50 / 10	220-240 / 50 / 10	220-240 / 50 / 10
Dimensions								
Height (cm)	82,0	82,0	82,0	82,0	82,0	82,0	82,0	82,0
Width (cm)	45,0	45,0	45,0	45,0	45,0	45,0	45,0	45,0
Depth (cm)	57,0	57,0	57,0	57,0	57,0	57,0	57,0	57,0
Height adjustment (+cm)	5	5	5	5	5	5	5	5
Adjustable Plinth for undertable usage (mm)	-	-	-	-	-	-	-	-
Possible adjustment of the plinth (horizontal/ vertical) (mm/mm)	-	-	-	-	-	-	-	-
Height without worktop (cm)	-	-	-	-	-	-	-	-
Packed dimensions (Height x Width x Depth) (cm)	86.1 x 49.4 x 66.1	86.1 x 49.4 x 66.1	86.1 x 49.4 x 66.1	86.1 x 49.4 x 66.1	86.1 x 49.4 x 66.1	86.1 x 49.4 x 66.1	86.1 x 49.4 x 66.1	86.1 x 49.4 x 66.1
Stacking quantity (pcs)	5	5	5	5	5	5	5	5
Gross/Net weight (kg) (3)	34/32	34/32	34/32	34/32	34/32	34/32	34/32	34/32
Container loading (40"HC/40"/20")	216/144/72	216/144/72	216/144/72	216/144/72	216/144/72	216/144/72	216/144/72	216/144/72

SPECIFICATIONS

FULLY INTEGRATED - 45cm Models	D12 45cm	D22 45cm	D32 45cm	D42 45cm	D41 45cm	D51 45cm	D52 45cm	D53 45cm
General Characteristics								
Number of place settings (PS)	10	10	10	10	10	10	10	10
Number of programs	3	6	8	8+	8+	6	8+	8+
Temperatures (°C)	50-65	40-50-65-70	40-50-60-65-70	Auto-30-40-50-60-65-70	Auto-30-40-50-60-65-70	30-40-50-60-65	Auto-30-40-50-60-65-70	Auto-30-40-50-60-65-70
Control type	full-electronic	full-electronic	full-electronic	full-electronic	full-electronic	Touch control	Touch control	Touch control
Hidden heating element	Yes	Yes	Yes	Yes	Yes	Yes	Yes	Yes
Filter type	Metal	Metal	Metal	Metal	Metal	Metal	Metal	Metal
Tub material	Stainless Steel	Stainless Steel	Stainless Steel	Stainless Steel	Stainless Steel	Stainless Steel	Stainless Steel	Stainless Steel
Turbidity sensor (Smart Wash)	-	-	-	Yes	Yes	-	Yes	Yes
Drying system	Mini Active/Super Active	Mini Active/Super Active	Mini Active/Super Active	Mini Active/Super Active	Turbo	Mini Active/Super Active	Turbo	Turbo
Divisor system	-	-	-	Yes	Yes	-	Yes	Yes
Overflow & leakage protection	Yes	Yes	Yes	Yes	Yes	Yes	Yes	Yes
Heater protection	Yes	Yes	Yes	Yes	Yes	Yes	Yes	Yes
Circulation pump	Asynchronous	Asynchronous	Asynchronous	Asynchronous	Asynchronous	Asynchronous	Asynchronous	BLDC
Auto Door	-	-	-	-	-	-	-	Yes
Water Box	-	-	-	-	-	-	-	-
Triple & Direct Wash	-	-	-	-	-	-	-	-
Wi-fi	-	-	-	-	-	-	-	-
Available Aesthetics	Alinda, Spero	Alinda, Spero	Alinda, Spero	Alinda, Spero	Alinda, Spero	Hemen, Hemen (Inox look)	Hemen, Hemen (Inox look)	Hemen, Hemen (Inox look)
Programs								
Prewash	Yes	Yes	Yes	Yes	Yes	-	-	-
Mini 18' (Jet Wash)	-	-	-	-	-	Yes	Yes	Yes
Quick 30' 40°C	-	Yes	Yes	Yes	Yes	Yes	Yes	Yes
Eco	Yes	Yes	Yes	Yes	Yes	Yes	Yes	Yes
Super 50' 65°C (Quick Clean)	-	Yes	Yes	Yes	Yes	Yes	Yes	Yes
Super 55' 60°C	-	-	-	-	-	-	-	-
Delicate 40°C	-	-	Yes	-	-	-	-	-
Normal 55°C	-	-	-	-	-	-	-	-
Daily 60°C	-	-	Yes	-	-	-	-	-
Dual Pro Wash 60°C	-	-	-	-	-	-	-	Yes
Hygiene 60°C	-	-	-	-	-	Yes	Yes	Yes
Hygiene 70°C	-	Yes	Yes	Yes	Yes	-	-	-
Intensive 65°C	Yes	Yes	Yes	-	-	Yes	-	-
Intensive 70°C	-	-	-	-	-	-	-	-
Auto Delicate 30°C - 50°C	-	-	-	Yes	Yes	-	Yes	Yes
Auto Normal 50°C - 60°C	-	-	-	Yes	Yes	-	Yes	-
Auto Intensive 60°C - 70°C	-	-	-	Yes	Yes	-	Yes	Yes (50°C-70°C)
Extra Intensive 70°C (Prewash Button + Intensive 65°C)	-	-	-	-	-	-	-	-
Extra Hygiene 70°C (Prewash Button + Hygiene 60°C)	-	-	-	-	-	-	-	-
Steam Wash	-	-	-	-	-	-	-	-
Eco 5.4 lt	-	-	-	-	-	-	-	-
User Interface								
Start/Pause button	-	-	-	-	-	-	-	-
DISPLAY (delay start, remaining time)	-	-	Yes: LED Hidden display	Yes: LED Hidden display	Yes: LED Hidden display	Yes: Icon LED Hidden display	Yes: Icon LED Hidden display	Yes: Icon LED Hidden display
Prewash button	-	-	-	-	-	-	-	-
Program selection button	Yes	Yes	Yes	Yes	Yes	Yes	Yes	Yes
Delay timer option	-	Yes (3hr, 6hr, 9hr)	Yes (1-2-3-...-19hr)	Yes (1-2-3-...-19hr)	Yes (1-2-3-...-19hr)	Yes (1-2-3-...-19hr)	Yes (1-2-3-...-19hr)	Yes (1-2-3-...-19hr)
Eco Wash - Half load option (with 1 mode)	-	Yes	Yes	-	-	Yes	-	-
Eco Wash - Half load option (with 3 modes)	-	-	-	Yes	Yes	-	Yes	Yes
Tablet option	-	Yes	Yes	Yes	Yes	Yes	Yes	Yes
Extra Hygiene option	-	-	-	-	-	-	-	-
Extra Rinse option	-	-	-	-	-	-	Yes	-
Extra Drying option	-	-	-	-	-	-	-	-
Extra Silent option (Silent Wash)	-	-	-	-	-	-	-	Yes
Extra Fast option	-	-	-	-	-	-	-	Yes
Energy Save option	-	-	-	-	-	-	-	Yes
Rinse-aid indicator	Yes	Yes	Yes	Yes	Yes	Yes	Yes	Yes
Salt indicator	Yes	Yes	Yes	Yes	Yes	Yes	Yes	Yes
Washing cycle indicators	-	-	-	-	-	-	-	-
End of cycle indicator	Yes	Yes	Yes	Yes	Yes	-	-	-
Child Lock	-	-	-	-	-	-	-	-
Buzzer	Yes	Yes	Yes	Yes	Yes	Yes	Yes	Yes
InfoLED	-	-	-	-	-	(o)	(o)	(o)
Baskets & Accessories								
3rd basket (Easy Tray)	No	-	-	-	(o)	-	(o)	Yes
Adjustable upper basket when empty	Yes	Yes	Yes	Yes	Yes	Yes	Yes	Yes
Adjustable upper basket when loaded	(o)	(o)	(o)	(o)	(o)	(o)	(o)	(o)
Number of mug shelves	4 (std)	4 (std)	4 (std)	4 (std)	4 (std)	4 (std)	4 (std)	4 (std)
Mug shelves with soft touch rubber	(o)	(o)	(o)	(o)	(o)	(o)	(o)	(o)
Foldable racks on upper basket	(o)	(o)	(o)	(o)	(o)	(o)	(o)	(o)
Foldable racks on lower basket	(o)	(o)	(o)	(o)	(o)	(o)	(o)	(o)
Plastic basket handles	(o)	(o)	(o)	(o)	(o)	(o)	(o)	(o)
Removable cutlery basket (Universal)	Yes	Yes	Yes	Yes	(Yes) with 2 baskets / (o) with 3rd basket	Yes	(Yes) with 2 baskets / (o) with 3rd basket	(o)
Wine glass holder on lower basket	(o) with foldable racks	(o) with foldable racks	(o) with foldable racks	(o) with foldable racks	(o) with foldable racks	(o) with foldable racks	(o) with foldable racks	(o) with foldable racks
Top nozzle [rotating / fixed]	(Yes) fixed	(Yes) fixed	(Yes) fixed	(Yes) fixed	(Yes) fixed with 2 baskets / rotating with 3rd basket	(Yes) fixed	(Yes) fixed with 2 baskets / rotating with 3rd basket	(Yes) rotating
Aquastop external hose	(o)	(o)	(o)	(o)	(o)	(o)	(o)	(o)

SPECIFICATIONS

FULLY INTEGRATED - 45cm Models	D12 45cm	D22 45cm	D32 45cm	D42 45cm	D41 45cm	D51 45cm	D52 45cm	D53 45cm
Baskets & Accessories								
Antibacterial filter	(o)	(o)	(o)	(o)	(o)	(o)	(o)	(o)
Interior light	-	-	-	(o)	(o)	-	(o)	(o)
Technical Data (1)								
Noise Level (dB(A))	57/54/52/49/47/45	57/54/52/49/47/45	57/54/52/49/47/45	54/52/49/47/45	52/49/47/45	57/54/52/49/47/45	54/52/49/47/45	44
Energy efficiency class	A++	A++	A++	A++	A++	A++	A++	A+++
Cleaning performance	A	A	A	A	A	A	A	A
Drying performance	A	A	A	A	A	A	A	A
Water consumption (lt)	11	11	11	9	9	11	9	9
Annual water consumption (lt/year)	3080	3080	3080	2520	2520	3080	2520	2520
Program duration (min)	198	198	198	198	198	198	198	185
Energy consumption (kWh)	0,73	0,73	0,73	0,73	0,73	0,73	0,73	0,65
Annual energy consumption (kWh/year)	211	211	211	211	211	211	211	188
Off mode power consumption (W)	0,50	0,50	0,50	0,50	0,50	0,50	0,50	0,50
Left-on mode power consumption (W)	1,00	1,00	1,00	1,00	1,00	1,00	1,00	1,00
Duration of left-on mode (min)	N/A	N/A	N/A	N/A	N/A	N/A	N/A	N/A
Power rating (W) / Heating element (W)	1900/1800	1900/1800	1900/1800	1900/1800	1900/1800	1900/1800	1900/1800	1900/1800
Plug Type	EU / UK / Swiss / Italy / Israel / AU / NZ / China / Argentina / S.Africa	EU / UK / Swiss / Italy / Israel / AU / NZ / China / Argentina / S.Africa	EU / UK / Swiss / Italy / Israel / AU / NZ / China / Argentina / S.Africa	EU / UK / Swiss / Italy / Israel / AU / NZ / China / Argentina / S.Africa	EU / UK / Swiss / Italy / Israel / AU / NZ / China / Argentina / S.Africa	EU / UK / Swiss / Italy / Israel / AU / NZ / China / Argentina / S.Africa	EU / UK / Swiss / Italy / Israel / AU / NZ / China / Argentina / S.Africa	EU / UK / Swiss / Italy / Israel / AU / NZ / China / Argentina / S.Africa
Power cord length (cm)	180	180	180	180	180	180	180	180
Water inlet hose length (cm)	147 (170 for Aquastop ex. hose)	147 (170 for Aquastop ex. hose)	147 (170 for Aquastop ex. hose)	147 (170 for Aquastop ex. hose)	147 (170 for Aquastop ex. hose)	147 (170 for Aquastop ex. hose)	147 (170 for Aquastop ex. hose)	147 (170 for Aquastop ex. hose)
Water outlet hose length (cm)	200	200	200	200	200	200	200	200
Voltage (V) / Frequency (Hz) / Fuse Rating (A)	220-240 / 50 / 10	220-240 / 50 / 10	220-240 / 50 / 10	220-240 / 50 / 10	220-240 / 50 / 10	220-240 / 50 / 10	220-240 / 50 / 10	220-240 / 50 / 10
Dimensions								
Height (cm)	82,0	82,0	82,0	82,0	82,0	82,0	82,0	82,0
Width (cm)	45,0	45,0	45,0	45,0	45,0	45,0	45,0	45,0
Depth (cm)	55,0	55,0	55,0	55,0	55,0	55,0	55,0	55,0
Height adjustment (+cm)	5	5	5	5	5	5	5	5
Adjustable Plinth for undertable usage (mm)	-	-	-	-	-	-	-	-
Possible adjustment of the plinth (horizontal/vertical) (mm/mm)	-	-	-	-	-	-	-	-
Height without worktop (cm)	-	-	-	-	-	-	-	-
Packed dimensions (Height x Width x Depth) (cm)	86.1 x 49.4 x 66.1	86.1 x 49.4 x 66.1	86.1 x 49.4 x 66.1	86.1 x 49.4 x 66.1	86.1 x 49.4 x 66.1	86.1 x 49.4 x 66.1	86.1 x 49.4 x 66.1	86.1 x 49.4 x 66.1
Stacking quantity (pcs)	5	5	5	5	5	5	5	5
Gross/Net weight (kg)(2)	34/32	34/32	34/32	34/32	34/32	34/32	34/32	34/32
Container loading (40"HC/40"/20")	216/144/72	216/144/72	216/144/72	216/144/72	216/144/72	216/144/72	216/144/72	216/144/72

(o) : Optional

(1) : Based on the tests performed with Eco programme in accordance with European Household Dishwasher Performance Standards

(2) : Gross/Net Weights are shown as reference in the table. It should be calculated based on the final product features created from this general spect table.

SPECIFICATIONS

60cm BUILT-IN OVEN SPECIFICATION SHEET		60cm ELECTRIC BUILT-IN OVEN	60cm PYROLYTIC BUILT-IN OVEN	60cm ELECTRIC POLYVALENTE BUILT-IN OVEN
Dimensions				
Product Height	mm	595	595	595
Product Width	mm	595	595	595
Product Depth (with/without Control Panel)	mm	575/550	575/550	575/550
Cabinet Dimensions (Width/Height/Depth) -If control panel located inside the cabinet	mm	600/600/590	600/600/590	600/600/590
Cabinet Dimensions (Width/Height/Depth) -If control panel not located inside the cabinet	mm	560/590/555	560/590/555	560/590/555
Oven Features				
Oven Type		Electric	Electric (Pyrolytic)	Electric
Oven Volume (without/with fan)	lt	61/56 - 72/65	56 (old platform) 65 (new platform)	61/56 - 72/65
Cavity Dimensions (without/with fan)	mm	430 x 429 x 335/430 x 391 x 335 - 450 x 451 x 352/450 x 413x 352	430 x 391 x 335 (old platform) 450 x 404 x 352 (new platform)	430 x 429 x 335/430 x 391 x 335 - 450 x 451 x 352/450 x 413x 352
Oven Light (25W)		Optional	Standard	Optional
Easy to Clean Enamel		Standard	-	Standard
Catalytic Enamel Panels (Left, right and rear)		Optional	-	Optional
Pyrolytic Enamel		-	Standard	-
Wire Side Racks		Optional	Optional	Optional
Telescopic Rails (1 or 2 racks)		Optional	Optional	Optional
Top Heating Element	W	1200	1200	1200
Bottom Heating Element	W	1100	1100	1100
Thermostat		Standard	Electronic	Standard
Grill (Thermostatic)	W	1400	1400	1400
Double Grill (Thermostatic)	W	2600	2600	2600
Fan	W	23	23	23
Fan with Ring Heating Element	W	2000	2000	2000
Automatic Boost Function		available for some control unit	available for some control unit	available for some control unit
Turnspit		Optional	Optional	Optional
Oven Functions		Up to 9	Up to 7	Up to 9
Thermostat Operation Indicator Light		Standard	Standard	Standard
Oven Operation Indicator Light		Standard	-	-
Hotplate Operation Indicator Light (in case of polyvalente oven)		-	-	Standard
Oven Door lock indicator light		-	Standard	-
Minute Minder		Optional	-	Optional
Mechanical Timer		Optional	-	Optional
Analog Timer		Optional	-	Optional
Digital Clock		Optional	-	Optional
Digital Programmer		Optional	Standard	Optional
Digital Programmer with touch interface		Optional	-	Optional
Full Touch LED Display		Optional	Optional	Optional
Knob Control LED Display and Touch Interface (Visio Touch)		Optional	Optional	-
Knob Control LED Display (Visio Display)		Optional	-	-
Smart LCD (Ready Cook)		Optional	-	-
Monochrome LCD		Optional	-	-
Baking Tray (Shallow Tray)		Optional	1	Optional
Roasting Tray (Deep Tray)		1	Optional	1
Glass Tray		Optional	Optional	Optional
Chromed Grid with Stoper		1	1	1
Wire grid for deep tray		Optional	Optional	Optional
Broil Pan with Handle Set		Optional	Optional	Optional
Self Cleaning Period	hours	-	1,5/1	-
Energy Consumption during Self Cleaning Function	kwh	-	2,6	-
Available Colours				
White		Standard	Standard	Standard
Black		Optional	Optional	Optional
Stainless Steel		Optional	Optional	Optional
Terre De France		Optional	Optional	Optional
Mink		Optional	Optional	Optional
Claret Red		Optional	Optional	Optional
Cream		Optional	Optional	Optional
Rustik (Black/White/Cream)		Optional	Optional	Optional
Silver		Optional	Optional	Optional
Control Panel				
Metal		Standard	Standard	Standard
Glass		Optional	Optional	Optional
Various Types of Inox Add-on on Glass Control Panel		Optional	Optional	Optional
Oven Door				
Full outer glass and small inner glass with metal frame (4 glasses)		-	Standard	-
Full inner glass and full glass front face (4 glasses) Oven Door		-	Optional	-
Full outer glass and Inner metal door (small glass) Oven Door		Standard	-	Standard
Full outer glass and inner glass Oven Door		Optional	-	Optional
Full outer glass and full inner glass Oven Door		Optional	-	Optional
Cool touch Oven door		Optional	-	Optional
Mirror Oven Door Glass		Optional	-	Optional
Removable Oven Door		Standard	Standard	Standard
Various Types of Inox Add-on on Oven Door Glass		Optional	Optional	Optional
Child Lock on Oven Door		Optional	Standard (Electromechanic)	Optional
Others				
Total Power (Depends on Model) Maximum	kW	3,1	2,6	3,1
Tangential Cooling Fan (in case of built-in oven with cooling fan)	W	11,5	23/40 (double level)	11,5
Tangential Cooling Fan Noise Level	dBa	49	53 (for pyrolytic function) 49 (for cooking function)	49
Voltage	V	230	230	230
Electric Cooker Energy Rating (Depends on Model)		A++/A+/A	A	A
Cavity Insulation		White/Yellow	White (with Aluminum foil)	White/Yellow
Pop-in/Pop-out Knob		Optional	Optional	Optional
Hob controls on Control Panel (in case of polyvalente oven)		Standard	-	Standard
Main Cable		Standard	Standard	Standard
Shrink Packed Product Dimensions (Width/Depth/Height)	mm	680 x 630 x 640	680 x 630 x 640	680 x 630 x 640
Carton Box Packaging		Optional	Optional	Optional
RoHS Compliance		Standard	Standard	Standard
CE Compliance		Standard	Standard	Standard
Net Weight (Depends on Model) Maximum	kg	35	34	35
Gross Weight (Depends on Model) Maximum	kg	37,7	36,2	37,7
Container Loading Quantity (20 ft Container)	pcs	81	81	81
Container Loading Quantity (40 ft Container)	pcs	162	162	162
Container Loading Quantity (40 ft HC Container)	pcs	216	216	216

SPECIFICATIONS

60cm BUILT-IN OVEN SPECIFICATION SHEET		60cm ELECTRIC BUILT-IN OVEN (75L)	60cm ELECTRIC POLYVALENTE BUILT-IN OVEN (75L)
Dimensions			
Product Height	mm	595	595
Product Width	mm	595	595
Product Depth (with/without Control Panel)	mm	575/550	575/550
Cabinet Dimensions (Width/Height/Depth) -If control panel located inside the cabinet	mm	600/600/590	600/600/580
Cabinet Dimensions (Width/Height/Depth) -If control panel not located inside the cabinet	mm	560/590/555	560/580/555
Oven Features			
Oven Type		Electric	Electric
Oven Volume (without/with fan)	lt	80/73(mold runners) - 85/78(wire rack)	80/73(mold runners) - 85/78(wire rack)
Cavity Dimensions (without/with fan)	mm	450 x 451 x 392/450 x 413x 392	450 x 451 x 392/450 x 413x 392
Oven Light (25W)		Standard	Standard
Easy to Clean Enamel		Standard	Standard
Catalytic Enamel Panels (Left, right and rear)		Optional	Optional
Wire Side Racks		Optional	Optional
Telescopic Rails (1 or 2 racks)		Optional	Optional
Top Heating Element	W	1200	1200
Bottom Heating Element	W	1100	1100
Thermostat		Standard	Standard
Grill (Thermostatic)	W	1400	1400
Double Grill (Thermostatic)	W	2600	2600
Fan	W	23	23
Fan with Ring Heating Element	W	2000	2000
Automatic Boost Function		available for some control unit	available for some control unit
Turnspit		Optional	Optional
Oven Functions		Up to 9	Up to 9
Thermostat Operation Indicator Light		Standard	Standard
Oven Operation Indicator Light		Standard	-
Hotplate Operation Indicator Light (in case of polyvalente oven)		-	Standard
Minute Minder		Optional	Optional
Mechanical Timer		Optional	Optional
Digital Clock		Optional	Optional
Digital Programmer		Optional	Optional
Digital Programmer with touch interface		Optional	Optional
Knob Control LED Display and Touch Interface (Visio Touch)		Optional	-
Knob Control LED Display (Visio Display)		Optional	-
Smart LCD (Ready Cook)		Optional	-
Monochrome LCD		Optional	-
Baking Tray (Shallow Tray)		Optional	Optional
Roasting Tray (Deep Tray)		1	1
Glass Tray		Optional	Optional
Chromed Grid with Stoper		1	1
Wire grid for deep tray		Optional	Optional
Broil Pan with Handle Set		Optional	Optional
Available Colours			
White		Standard	Standard
Black		Optional	Optional
Stainless Steel		Optional	Optional
Terre De France		Optional	Optional
Mink		Optional	Optional
Claret Red		Optional	Optional
Cream		Optional	Optional
Rustik (Black/White/Cream)		Optional	Optional
Silver		Optional	Optional
Control Panel			
Metal		Standard	Standard
Glass		Optional	Optional
Various Types of Inox Add-on on Glass Control Panel		Optional	Optional
Oven Door			
Full outer glass and full inner glass Oven Door		Standard	Standard
Mirror Oven Door Glass		Optional	Optional
Removable Oven Door		Standard	Standard
Various Types of Inox Add-on on Oven Door Glass		Optional	Optional
Others			
Total Power (Depends on Model) Maximum	kW		
Tangential Cooling Fan (in case of built-in oven with cooling fan)	W	11,5	11,5
Tangential Cooling Fan Noise Level	dB(A)	49	49
Voltage	V	230	230
Electric Cooker Energy Rating (Depends on Model)		A+/A	A
Cavity Insulation		White/Yellow	White/Yellow
Pop-in/Pop-out Knob		Optional	Optional
Hob controls on Control Panel (in case of combi oven)		Standard	Standard
Main Cable		Standard	Standard
Shrink Packed Product Dimensions (Width/Depth/Height)	mm	680 x 630 x 640	680 x 630 x 640
Carton Box Packaging		Optional	Optional
RoHS Compliance		Standard	Standard
CE Compliance		Standard	Standard
Net Weight (Depends on Model) Maximum	kg	36	36
Gross Weight (Depends on Model) Maximum	kg	38,2	38,2
Container Loading Quantity (20 ft Container)	pcs	81	81
Container Loading Quantity (40 ft Container)	pcs	162	162
Container Loading Quantity (40 ft HC Container)	pcs	216	216

BUILT-IN / TABLE-TOP HOB SPECIFICATION SHEET		BI Gas/Combined Hobs							
		60 CM Flat/Surface	60 CM Extenda	60 CM Classic	60 CM Model I	60 CM PlusX	60 CM Division	70 CM Model I	70 CM PlusX
Available Colours									
White		Standard	Standard	Standard	Standard	Standard	-	Standard	Standard
Brown		Optional	Optional	Optional	Optional	Optional	-	Optional	Optional
Terre de France		Optional	Optional	Optional	Optional	Optional	-	Optional	Optional
Black		Optional	Optional	Optional	Optional	Optional	-	Optional	Optional
Dark Green		Optional	Optional	Optional	Optional	Optional	-	Optional	Optional
Stainless Steel		Optional	Optional	Optional	Optional	Optional	Standard	Optional	Optional
Product Dimensions									
Height (max., varies from model to model)	mm	40	40	40	39,5	42	42	39,5	42
Width	mm	580	580	580	590	580	580	680	700
Depth (max., do not include gas connection detail)	mm	510	510	510	515	515	510	515	515
Cut-out Dimensions									
Width	mm	560	560	560	560	560	560	560	560
Depth	mm	490	490	490	490	490	490	490	490
Hob Features									
Hob		Enamel/ Stainless Steel	Enamel/ Stainless Steel	Enamel/ Stainless Steel	Enamel/ Stainless Steel	Enamel/ Stainless Steel	Stainless Steel	Enamel/ Stainless Steel	Enamel/ Stainless Steel
Rapid Gas Burner Ø10cm	W	3000	3000	3000	3000	3000	3000	3000	3000
Semi-rapid Gas Burner Ø7.5cm	W	1750	1750	1750	1750	1750	1750	1750	1750
Auxiliary Gas Burner Ø5.5cm	W	1000	1000	1000	1000	1000	1000	1000	1000
Wok (Triple Flame) Gas Burner Mono Ø14cm	W	3600	3600	3600	3600	-	-	3600	3600
Wok (Triple Flame) Gas Burner Dual Ø14cm	W	-	-	-	-	-	-	-	-
Wok (Triple Flame) Gas Burner Ø11cm	W	-	-	-	-	3200	-	-	-
Ø145 mm Hotplate	W	-	-	1000	1000	1000	-	1000	1000
Ø180 mm Hotplate	W	1500	1500	-	-	-	-	-	-
Ø145 mm Rapid Hotplate	W	-	-	-	-	-	-	-	-
Ø180 mm Rapid Hotplate	W	-	-	-	-	-	-	-	-
Ø145 mm Highlight Element	W	-	-	-	-	-	-	-	-
Ø180 mm Highlight Element	W	-	-	-	-	-	-	-	-
Ø210 mm Highlight Element	W	-	-	-	-	-	-	-	-
Ø180 mm Dual Highlight Element	W	-	-	-	-	-	-	-	-
Ø145 mm Oval Highlight Element	W	-	-	-	-	-	-	-	-
Ø210 mm Dual Highlight Element	W	-	-	-	-	-	-	-	-
Ø210 mm Triple Highlight Element	W	-	-	-	-	-	-	-	-
Ø290 mm Dual/Triple Highlight Element	W	-	-	-	-	-	-	-	-
Ø160 mm Induction Zone(Serie 1 and Serie 2)	W	-	-	-	-	-	-	-	-
Ø200 mm Induction Zone(Serie 1)	W	-	-	-	-	-	-	-	-
Ø210 mm Induction Zone(Serie 2)	W	-	-	-	-	-	-	-	-
Ø250 mm Induction Zone(Serie 1)	W	-	-	-	-	-	-	-	-
Ø290 mm Induction Zone(Serie 2)	W	-	-	-	-	-	-	-	-
Boost Funcion	-	-	-	-	-	-	-	-	-
Pot Dedection	-	-	-	-	-	-	-	-	-
Automatic Heatup	-	-	-	-	-	-	-	-	-
Timer function for vitro ceramic hobs (If touch control with some hob configuration selected)	-	-	-	-	-	-	-	-	-
Mode function for induction ceramic hobs (If touch control with some hob configuration selected)	-	-	-	-	-	-	-	-	-
Bridge zone for induction ceramic hobs (If touch control with some hob configuration selected)	-	-	-	-	-	-	-	-	-
Child Lock for vitro ceramic hobs (If touch control selected)	-	-	-	-	-	-	-	-	-
Mechanical Child Lock (Main Switch)	-	-	-	-	-	-	-	-	-
Hot Surface Indicator Light	-	-	-	-	-	-	-	-	-
Hotplate Operation Indicator Light	Standard	Standard	Standard	Standard	Standard	Standard	-	Standard	Standard
Side Knob Control	Standard	Standard	Standard	-	-	-	-	-	-
Side Touch Control	-	-	-	-	-	-	-	-	-
Front Knob Control	-	-	-	Standard	Standard	-	-	Standard	Standard
Double Side Front Control	-	-	-	-	-	-	Standard	-	-
Front Triangular Touch Control	-	-	-	-	-	-	-	-	-
Front Slider Touch Control	-	-	-	-	-	-	-	-	-
Front Touch Control	-	-	-	-	-	-	-	-	-
Bevelled Edges	-	-	-	-	-	-	-	-	-
Logo	Standard	Standard	Standard	Standard	Standard	Standard	Standard	Standard	Standard
Special Decoration on Glass	-	-	-	-	-	-	-	-	-
Vitroceraic Glass Artwork	-	-	-	-	-	-	-	-	-
Inox Frame	-	-	-	-	-	-	-	-	-
Stainless Steel Burner Pan	-	-	-	-	-	-	-	-	-
Table Top Installation (not built-in)	Optional	Optional	Optional	-	-	-	-	-	-
Glass Lid	-	-	-	-	-	-	-	-	-
Burner Safety Valves	Standard	Standard	Standard	Standard	Standard	Standard	Standard	Standard	Standard
Buton Ignition	Optional	Optional	Optional	Optional	-	-	-	Optional	-
One-touch-Ignition through knobs	Optional	Optional	Optional	Optional	Optional	Optional	Standard	Optional	Optional
Enamel Pan Supports	Standard	Standard	Standard	Standard	Standard	Standard	-	Standard	Standard
Cast Iron Pan Supports	Optional	Optional	-	Optional	Optional	Optional	Standard	Optional	Optional
Cast Iron Burner Caps	Optional	Optional	-	Optional	Optional	Optional	Optional	Optional	Optional
Coffee Adaptor	Optional	Optional	Optional	Optional	Optional	Optional	Optional	Optional	Optional
Wok Adaptor	Optional	Optional	Optional	Optional	Optional	Optional	-	Optional	Optional
Vitroceraic Glass Cleaning Spatula	-	-	-	-	-	-	-	-	-
Gas Conversion Kit	Standard	Standard	Standard	Standard	Standard	Standard	Standard	Standard	Standard
Others									
Total Gas Power (Depends on Model) Maximum	kW	8,1	8,1	8,1	8,1	7,7	7,5	11,1	11,1
Total Electric Power (Depends on Model) Maximum	kW	1,5	1,5	1	1	1	-	1	1
Voltage	V	230V~	230V~	230V~	230V~	230V~	230V~	230V~	230V~
RoHS Compliance		Standard	Standard	Standard	Standard	Standard	Standard	Standard	Standard
CE Compliance		Standard	Standard	Standard	Standard	Standard	Standard	Standard	Standard
Carton Box Packaging		Standard	Standard	Standard	Standard	Standard	Standard	Standard	Standard
Packed Product Dimensions (WxDxH)	mm	626 x 580 x 140	x	626 x 560 x 130	641 x 576 x 161	x	x	731 x 576 x 161	x
Loading Quantity 20 ft (Wrapped Carton)	pcs	576	x	612	448	x	x	420	x
Loading Quantity 40 ft (Wrapped Carton)	pcs	1216	x	1292	1008	x	x	896	x
Loading Quantity 40 HC (Wrapped Carton)	pcs	1368	x	1444	1152	x	x	1024	x
Packed Product Dimensions (WxDxH) Box	mm	640 x 584 x 152	647 x 582 x 164	635 x 564 x 142	x	647 x 582 x 164	647 x 582 x 164	x	769 x 582 x 164
Loading Quantity 20 ft (Carton Box)	pcs	405	378	576	x	378	378	x	378
Loading Quantity 40 ft (Carton Box)	pcs	900	840	1152	x	840	840	x	840
Loading Quantity 40 HC (Carton Box)	pcs	1020	960	1296	x	960	960	x	960
Net Weight (Depends on Model) Maximum	kg	9	9,5	6,6	9,8	9,5	11	10,7	12,5
Gross Weight (Depends on Model) Maximum	kg	9,75	10,5	7,5	10,6	10,5	12	11,6	13,5

SPECIFICATIONS

BUILT-IN / TABLE-TOP HOB SPECIFICATION SHEET		BI Gas Securit Hobs							
		60 CM Securit II	60 CM Trio	60 CM Model I	60 CM PlusX	60 CM Division	70 CM Model I	70 CM PlusX	90 CM
Available Colours									
White		Optional	Optional	Optional	Optional	-	Optional	Optional	Optional
Brown		Optional	Optional	Optional	Optional	-	Optional	Optional	Optional
Terre de France		Optional	Optional	Optional	Optional	-	Optional	Optional	Optional
Black		Standard	Standard	Standard	Standard	Standard	Standard	Standard	STANDARD
Dark Green		Optional	Optional	Optional	Optional	-	Optional	Optional	Optional
Stainless Steel		-	-	-	-	-	-	-	-
Product Dimensions									
Height (max., varies from model to model)	mm	44	44	39,5	44	44	39,5	44	47
Width	mm	594	594	590	594	594	680	700	882
Depth (max., do not include gas connection detail)	mm	523	523	515	523	523	515	520	520
Cut-out Dimensions									
Width	mm	560	560	560	560	560	560	560	850
Depth	mm	490	490	490	490	490	490	490	480
Hob Features									
Hob		Securit	Securit	Securit	Securit	Securit	Securit	Securit	Securit
Rapid Gas Burner Ø10cm	W	3000	3000	3000	3000	3000	3000	3000	3000
Semi-rapid Gas Burner Ø7.5cm	W	1750	1750	1750	1750	1750	1750	1750	1750
Auxiliary Gas Burner Ø5.5cm	W	1000	1000	1000	1000	1000	1000	1000	1000
Wok (Triple Flame) Gas Burner Mono Ø14cm	W	3600	3600	3600	3600	-	3600	3600	4500
Wok (Triple Flame) Gas Burner Dual Ø14cm	W	-	-	-	-	-	-	-	4500
Wok (Triple Flame) Gas Burner Ø11cm	W	-	-	-	-	-	-	-	-
Ø145 mm Hotplate	W	-	-	-	1000	-	-	-	-
Ø180 mm Hotplate	W	-	-	-	-	-	-	-	-
Ø145 mm Rapid Hotplate	W	-	-	-	-	-	-	-	-
Ø180 mm Rapid Hotplate	W	-	-	-	-	-	-	-	-
Ø145 mm Highlight Element	W	-	-	-	-	-	-	-	-
Ø180 mm Highlight Element	W	-	-	-	-	-	-	-	-
Ø210 mm Highlight Element	W	-	-	-	-	-	-	-	-
Ø180 mm Dual Highlight Element	W	-	-	-	-	-	-	-	-
Ø145 mm Oval Highlight Element	W	-	-	-	-	-	-	-	-
Ø210 mm Dual Highlight Element	W	-	-	-	-	-	-	-	-
Ø210 mm Triple Highlight Element	W	-	-	-	-	-	-	-	-
Ø290 mm Dual/Triple Highlight Element	W	-	-	-	-	-	-	-	-
Ø160 mm Induction Zone (Serie 1 and Serie 2)	W	-	-	-	-	-	-	-	-
Ø200 mm Induction Zone (Serie 1)	W	-	-	-	-	-	-	-	-
Ø210 mm Induction Zone (Serie 2)	W	-	-	-	-	-	-	-	-
Ø250 mm Induction Zone (Serie 1)	W	-	-	-	-	-	-	-	-
Ø290 mm Induction Zone (Serie 2)	W	-	-	-	-	-	-	-	-
Boost Function		-	-	-	-	-	-	-	-
Pot Dedection		-	-	-	-	-	-	-	-
Automatic Heatup		-	-	-	-	-	-	-	-
Timer function for vitro ceramic hobs (If touch control with some hob configuration selected)		-	-	-	-	-	-	-	-
Mode function for induction ceramic hobs (If touch control with some hob configuration selected)		-	-	-	-	-	-	-	-
Bridge zone for induction ceramic hobs (If touch control with some hob configuration selected)		-	-	-	-	-	-	-	-
Child Lock for vitro ceramic hobs (If touch control selected)		-	-	-	-	-	-	-	-
Mechanical Child Lock (Main Switch)		-	-	-	-	-	-	-	Optional
Hot Surface Indicator Light		-	-	-	-	-	-	-	-
Hotplate Operation Indicator Light		-	-	-	-	-	-	-	-
Side Knob Control		Standard	Standard	-	-	-	-	-	-
Side Touch Control		-	-	-	-	-	-	-	-
Front Knob Control		-	-	Standard	Standard	-	Standard	Standard	STANDARD
Double Side Front Control		-	-	-	-	Standard	-	-	-
Front Triangular Touch Control		-	-	-	-	-	-	-	-
Front Slider Touch Control		-	-	-	-	-	-	-	-
Front Touch Control		-	-	-	-	-	-	-	-
Bevelled Edges		-	-	-	-	-	-	-	Optional
Logo		Optional	Optional	STANDARD	STANDARD	Standard	STANDARD	STANDARD	STANDARD
Special Decoration on Glass		Optional	Optional	-	-	-	-	-	-
Vitroceraamic Glass Artwork		-	-	-	-	-	-	-	-
Inox Frame		-	-	STANDARD	-	-	STANDARD	-	Optional
Stainless Steel Burner Pan		Optional	Optional	Optional	Optional	-	Optional	Optional	Optional
Table Top Installation (not built-in)		-	-	-	-	-	-	-	-
Glass Lid		-	-	-	-	-	-	-	-
Burner Safety Valves		Standard	Standard	Standard	Standard	Standard	Standard	Standard	STANDARD
Button Ignition		Optional	Optional	Optional	-	-	Optional	Standard	STANDARD
One-touch-Ignition through knobs		Optional	Optional	Optional	Optional	Standard	Optional	Optional	STANDARD
Enamel Pan Supports		Standard	Standard	Standard	Standard	-	Standard	Standard	-
Cast Iron Pan Supports		Optional	Optional	Optional	Optional	Standard	Optional	Optional	STANDARD
Cast Iron Burner Caps		Optional	Optional	Optional	Optional	Optional	Optional	Optional	STANDARD
Coffee Adaptor		Optional	Optional	Optional	Optional	Optional	Optional	Optional	Optional
Wok Adaptor		Optional	Optional	Optional	Optional	-	Optional	Optional	Optional
Vitroceraamic Glass Cleaning Spatula		-	-	-	-	-	-	-	-
Gas Conversion Kit		Standard	Standard	Standard	Standard	Standard	Standard	Standard	Optional
Others									
Total Gas Power (Depends on Model) Maximum	kW	8,1	8,1	8,1	8,1	7,5	11,1	11,1	12
Total Electric Power (Depends on Model) Maximum	kW	-	-	-	1	-	-	-	-
Voltage	V	230V~	230V~	230V~	230V~	230V~	230V~	230V~	230V~
RoHS Compliance		Standard	Standard	Standard	Standard	Standard	Standard	Standard	Standard
CE Compliance		Standard	Standard	Standard	Standard	Standard	Standard	Standard	Standard
Carton Box Packaging		Standard	Standard	Standard	Standard	Standard	Standard	Standard	Standard
Packed Product Dimensions (WxDxH)	mm	622 x 580 x 140	622 x 580 x 140	641 x 576 x 161	x	x	731 x 576 x 161	x	x
Loading Quantity 20 ft (Wrapped Carton)		576 (without wok burner)	432 (with wok burner)	576	448	x	x	420	x
Loading Quantity 40 ft (Wrapped Carton)		1216 (without wok burner)	912 (with wok burner)	1216	1008	x	x	896	x
Loading Quantity 40 HC (Wrapped Carton)		1368 (without wok burner)	912 (with wok burner)	1368	1152	x	x	1024	x
Packed Product Dimensions (WxDxH) Box	mm	x	x	x	647 x 582 x 164	647 x 582 x 164	x	769 x 582 x 164	935 x 582 x 164
Loading Quantity 20 ft (Carton Box)	pcs	x	x	x	378	378	x	378	252
Loading Quantity 40 ft (Carton Box)	pcs	x	x	x	840	840	x	840	560
Loading Quantity 40 HC (Carton Box)	pcs	x	x	x	960	960	x	960	640
Net Weight (Depends on Model) Maximum	kg	9,5	9,5	10,7	11,5	-	13,7	13,8	20,5
Gross Weight (Depends on Model) Maximum	kg	10,25	10,25	11,13	12,5	-	14,2	14,8	21,5

BUILT-IN/TABLE-TOP HOB SPECIFICATION SHEET		BI Electric Hobs		BI Vitro Ceramic Hobs		BI Induction Ceramic Hobs			
		60 CM		60 CM	78 CM	60 CM		78 CM	90CM
		Flat/Surface		C Serie	C Serie	Vestel Induction	Vestel Induction	Vestel Induction	
Available Colours									
White		Standard	Optional	Optional	Optional	Optional	Optional		
Brown		Optional	-	-	-	-	-		
Terre de France		Optional	-	-	-	-	-		
Black		Optional	Standard	Standard	Standard	Standard	Standard		
Dark Green		Optional	-	-	-	-	-		
Stainless Steel		Optional	-	-	-	-	-		
Product Dimensions									
Height (max., varies from model to model)	mm	40	41- 47,5	41	56	56	56		
Width	mm	580	590	780	590	590	890		
Depth (max., do not include gas connection detail)	mm	510	520	520	520	520	520		
Cut-out Dimensions									
Width	mm	560	560	750	560	750	860		
Depth	mm	490	490	490	490	490	490		
Hob Features									
Hob		Enamel/Stainless Steel	Vitro Ceramic	Vitro Ceramic	Induction Ceramic	Induction Ceramic	Induction Ceramic		
Rapid Gas Burner Ø10cm	W	Enamel/Stainless Steel	Vitro Ceramic	Vitro Ceramic	Induction Ceramic	Induction Ceramic	Induction Ceramic		
Semi-rapid Gas Burner Ø7.5cm	W	-	-	-	-	-	-		
Auxiliary Gas Burner Ø5.5cm	W	-	-	-	-	-	-		
Wok (Triple Flame) Gas Burner Mono Ø14cm	W	-	-	-	-	-	-		
Wok (Triple Flame) Gas Burner Dual Ø14cm	W	-	-	-	-	-	-		
Wok (Triple Flame) Gas Burner Ø11cm	W	-	-	-	-	-	-		
Ø 145 mm Hotplate	W	-	-	-	-	-	-		
Ø 180 mm Hotplate	W	1000	-	-	-	-	-		
Ø 145 mm Rapid Hotplate	W	1500	-	-	-	-	-		
Ø 180 mm Rapid Hotplate	W	1500	-	-	-	-	-		
Ø145 mm Highlight Element	W	2000	-	-	-	-	-		
Ø180 mm Highlight Element	W	-	1200	1200	-	-	-		
Ø210 mm Highlight Element	W	-	1800	1800	-	-	-		
Ø180 mm Dual Highlight Element	W	-	2300	2300	-	-	-		
Ø145 mm Oval Highlight Element	W	-	1700	1700	-	-	-		
Ø210 mm Dual Highlight Element	W	-	1800	1800	-	-	-		
Ø210 mm Triple Highlight Element	W	-	2200	2200	-	-	-		
Ø290 mm Dual/Triple Highlight Element	W	-	2300	2300	-	-	-		
Ø 160 mm Induction Zone (Serie 1 and Serie 2)	W	-	2700	-	-	-	-		
Ø 200 mm Induction Zone (Serie 1)	W	-	-	-	Nominal 2100 W max. Boost 2500 W	Nominal 2100 W max. Boost 2500 W	Nominal 2100 W max. Boost 2500 W		
Ø 210 mm Induction Zone (Serie 2)	W	-	-	-	Nominal 2100 W max. Boost 2500 W	-	-		
Ø 250 mm Induction Zone (Serie 1)	W	-	-	-	Nominal 2800 W max. Boost 3500 W	Nominal 2800 W max. Boost 3500 W	Nominal 2800 W max. Boost 3500 W		
Ø 290 mm Induction Zone (Serie 2)	W	-	-	-	Nominal 2800 W max. Boost 3500 W	-	-		
Boost Function		-	-	-	Standard	Standard	Standard		
Pot Dedection		-	-	-	Standard	Standard	Standard		
Automatic Heatup		-	-	-	-	-	-		
Timer function for vitro ceramic hobs (If touch control with some hob configuration selected)		-	Optional	Optional	Optional	Optional	Standard		
Mode function for induction ceramic hobs (If touch control with some hob configuration selected)		-	-	-	Optional	Optional	-		
Bridge zone for induction ceramic hobs (If touch control with some hob configuration selected)		-	-	-	Optional	-	-		
Child Lock for vitro ceramic hobs (If touch control selected)		-	Standard	Standard	Standard	Standard	Standard		
Mechanical Child Lock (Main Switch)		-	-	-	-	-	-		
Hot Surface Indicator Light		-	Standard	Standard	Standard	Standard	Standard		
Hotplate Operation Indicator Light		Standard	-	-	-	-	-		
Side Knob Control		Standard	Standard	-	-	-	-		
Side Touch Control		-	Optional	-	-	-	-		
Front Knob Control		-	-	-	-	-	-		
Double Side Front Control		-	-	-	-	-	-		
Front Triangular Touch Control		-	Optional	Standard	-	-	-		
Front Slider Touch Control		-	Optional	Optional	Optional	Optional	-		
Front Touch Control		-	-	-	Optional	Optional	Optional		
Bevelled Edges		-	Optional	Optional	Optional	Optional	Optional		
Logo		Standard	Optional	Optional	Optional	Optional	Optional		
Special Decoration on Glass		-	Optional	Optional	Optional	Optional	Optional		
Vitroceramic Glass Artwork		-	Slim/Arc/Point	Slim/Arc/Point	Slim/ Plus/ Line	Slim/ Plus/ Line	Slim/ Plus/ Line		
Inox Frame		-	Optional	-	Optional	Optional	Optional		
Stainless Steel Burner Pan		-	-	-	-	-	-		
Table Top Installation (not built-in)		-	-	-	-	-	-		
Glass Lid		-	-	-	-	-	-		
Burner Safety Valves		-	-	-	-	-	-		
Button Ignition		-	-	-	-	-	-		
One-touch-Ignition through knobs		-	-	-	-	-	-		
Enamel Pan Supports		-	-	-	-	-	-		
Cast Iron Pan Supports		-	-	-	-	-	-		
Cast Iron Burner Caps		-	-	-	-	-	-		
Coffee Adaptor		-	-	-	-	-	-		
Wok Adaptor		-	-	-	-	-	-		
Vitroceramic Glass Cleaning Spatula		-	Optional	Optional	Optional	Optional	Optional		
Gas Conversion Kit		-	-	-	-	-	-		
Others									
Total Gas Power (Depends on Model) Maximum	kW	-	-	-	-	-	-		
Total Electric Power (Depends on Model) Maximum	kW	6	6,5	8,3	7,4	7,4	10,8		
Voltage	V	230V~/400V 2N~	230V~/400V 3N~	230V~/400V 3N~	230V~/400V 3N~	230V~/400V 3N~	230V~/400V 3N~		
RoHS Compliance		Standard	Standard	Standard	Standard	Standard	Standard		
CE Compliance		Standard	Standard	Standard	Standard	Standard	Standard		
Carton Box Packaging		Standard	Standard	Standard	Standard	Standard	Standard		
Packed Product Dimensions (WxDxH)	mm	626 x 580 x 140	620 x 578 x 133	810 x 578 x 133	626 x 581 x 142	816 x 581 x 142	926 x 581 x 142		
Loading Quantity 20 ft (Wrapped Carton)	pcs	576	612	476	432	336	252		
Loading Quantity 40 ft (Wrapped Carton)	pcs	1216	1292	952	960	672	560		
Loading Quantity 40 HC (Wrapped Carton)	pcs	1368	1444	1064	1080	756	560		
Packed Product Dimensions (WxDxH) Box	mm	640 x 584 x 152	631 x 580 x 143	x	643 x 583 x 152	x	941 x 583 x 152		
Loading Quantity 20 ft (Carton Box)	pcs	405	576	x	405	x	252		
Loading Quantity 40 ft (Carton Box)	pcs	900	1152	x	900	x	560		
Loading Quantity 40 HC (Carton Box)	pcs	1020	1296	x	1020	x	560		
Net Weight (Depends on Model) Maximum	kg	9,5	9,5	10,15	11	12	16		
Gross Weight (Depends on Model) Maximum	kg	10,25	10,25	11	12	13	17		

SPECIFICATIONS

BUILT-IN / TABLE-TOP HOB SPECIFICATION SHEET	TT Gas/Comnined/Gas Securit Hobs					TT Electric Hobs		
		60 CM	60 CM	60 CM	60 CM	60 CM	60 CM	60 CM
		Flat/Surface	Smoothline	New Gen.	PlusX	Flat/Surface	Smoothline	New Gen.
Available Colours								
White		Standard	Standard	Standard	Optional	Standard	Standard	Standard
Brown		Optional	Optional	-	Optional	Optional	Optional	-
Terre de France		Optional	Optional	-	Optional	Optional	Optional	-
Black		Optional	Optional	Optional	Standard	Optional	Optional	Optional
Dark Green		Optional	Optional	-	Optional	Optional	Optional	-
Stainless Steel		Optional	Optional	Optional	Optional	Optional	Optional	Optional
Product Dimensions								
Height (max., varies from model to model)	mm	95,5 - 104,5	95,5 - 104,5	95,5 - 104,5	104	56,5 - 104,5	56,5 - 104,5	56,5 - 104,5
Width	mm	585	585	580	597	585	585	585
Depth (max., do not include gas connection detail)	mm	540	540	540	526	540	540	540
Cut-out Dimensions								
Width	mm	-	-	-	-	-	-	-
Depth	mm	-	-	-	-	-	-	-
Hob Features								
Hob		Enamel/Stainless Steel	Enamel/Stainless Steel	Enamel/Stainless Steel	Securit	Enamel/Stainless Steel	Enamel/Stainless Steel	Enamel/Stainless Steel
Rapid Gas Burner Ø10cm	W	3000	3000	3000	3000	-	-	-
Semi-rapid Gas Burner Ø7.5cm	W	1750	1750	1750	1750	-	-	-
Auxiliary Gas Burner Ø5.5cm	W	1000	1000	1000	1000	-	-	-
Wok (Triple Flame) Gas Burner Mono Ø14cm	W	3600	3600	3600	3600	-	-	-
Wok (Triple Flame) Gas Burner Dual Ø14cm	W	-	-	-	-	-	-	-
Wok (Triple Flame) Gas Burner Ø11cm	W	-	-	-	-	-	-	-
Ø145 mm Hotplate	W	-	1000	-	1000	1000	1000	1000
Ø180 mm Hotplate	W	1500	-	1500	-	1500	1500	1500
Ø145 mm Rapid Hotplate	W	-	1500	-	-	1500	1500	1500
Ø180 mm Rapid Hotplate	W	2000	-	2000	-	2000	2000	2000
Ø145 mm Highlight Element	W	-	-	-	-	-	-	-
Ø180 mm Highlight Element	W	-	-	-	-	-	-	-
Ø210 mm Highlight Element	W	-	-	-	-	-	-	-
Ø180 mm Dual Highlight Element	W	-	-	-	-	-	-	-
Ø145 mm Oval Highlight Element	W	-	-	-	-	-	-	-
Ø210 mm Dual Highlight Element	W	-	-	-	-	-	-	-
Ø210 mm Triple Highlight Element	W	-	-	-	-	-	-	-
Ø290 mm Dual/Triple Highlight Element	W	-	-	-	-	-	-	-
Ø160 mm Induction Zone (Serie 1 and Serie 2)	W	-	-	-	-	-	-	-
Ø200 mm Induction Zone (Serie 1)	W	-	-	-	-	-	-	-
Ø210 mm Induction Zone (Serie 2)	W	-	-	-	-	-	-	-
Ø250 mm Induction Zone (Serie 1)	W	-	-	-	-	-	-	-
Ø290 mm Induction Zone (Serie 2)	W	-	-	-	-	-	-	-
Boost Function	-	-	-	-	-	-	-	-
Pot Dedection	-	-	-	-	-	-	-	-
Automatic Heatup	-	-	-	-	-	-	-	-
Timer function for vitro ceramic hobs (If touch control with some hob configuration selected)	-	-	-	-	-	-	-	-
Mode function for induction ceramic hobs (If touch control with some hob configuration selected)	-	-	-	-	-	-	-	-
Bridge zone for induction ceramic hobs (If touch control with some hob configuration selected)	-	-	-	-	-	-	-	-
Child Lock for vitro ceramic hobs (If touch control selected)	-	-	-	-	-	-	-	-
Mechanical Child Lock (Main Switch)	-	-	-	-	-	-	-	-
Hot Surface Indicator Light	-	-	-	-	-	-	-	-
Hotplate Operation Indicator Light	Standard	Standard	Standard	Standard	Standard	Standard	Standard	Standard
Side Knob Control	Standard	Standard	Standard	-	Standard	Standard	Standard	Standard
Side Touch Control	-	-	-	-	-	-	-	-
Front Knob Control	-	-	-	Standard	-	-	-	-
Double Side Front Control	-	-	-	-	-	-	-	-
Front Triangular Touch Control	-	-	-	-	-	-	-	-
Front Slider Touch Control	-	-	-	-	-	-	-	-
Front Touch Control	-	-	-	-	-	-	-	-
Bevelled Edges	-	-	-	-	-	-	-	-
Logo	Standard	Standard	Standard	Standard	Standard	Standard	Standard	Standard
Special Decoration on Glass	-	-	-	-	-	-	-	-
Vitrocereamic Glass Artwork	-	-	-	-	-	-	-	-
Inox Frame	-	-	-	-	-	-	-	-
Stainless Steel Burner Pan	-	-	-	-	-	-	-	-
Table Top Installation (not built-in)	Standard	Standard	Standard	Standard	Standard	Standard	Standard	Standard
Glass Lid	Optional	Optional	Optional	Optional	-	Optional	Optional	Optional
Burner Safety Valves	Standard	Standard	Standard	Standard	Standard	-	-	-
Button Ignition	Optional	Optional	Optional	Optional	Optional	-	-	-
One-touch-Ignition through knobs	Optional	Optional	Optional	Optional	Optional	-	-	-
Enamel Pan Supports	Standard	Standard	Standard	Standard	Standard	-	-	-
Cast Iron Pan Supports	Optional	Optional	Optional	Optional	Optional	-	-	-
Cast Iron Burner Caps	Optional	Optional	Optional	Optional	Optional	-	-	-
Coffee Adaptor	Optional	Optional	Optional	Optional	Optional	-	-	-
Wok Adaptor	Optional	Optional	Optional	Optional	Optional	-	-	-
Vitrocereamic Glass Cleaning Spatula	-	-	-	-	-	-	-	-
Gas Conversion Kit	Standard	Standard	Standard	Standard	Standard	-	-	-
Others								
Total Gas Power (Depends on Model) Maximum	kW	8,1	8,1	8,1	8,1	-	-	-
Total Electric Power (Depends on Model) Maximum	kW	-	-	-	1	6	6	6
Voltage	V	230V~	230V~	230V~	230V~	230/400V 3N~	230/400V 3N~	230/400V 3N~
RoHS Compliance		Standard	Standard	Standard	Standard	Standard	Standard	Standard
CE Compliance		Standard	Standard	Standard	Standard	Standard	Standard	Standard
Carton Box Packaging		Standard	Standard	Standard	Standard	Standard	Standard	Standard
Packed Product Dimensions (WxDxH)	mm	643 x 645 x 132	643 x 645 x 132	x	x	643 x 645 x 132	643 x 645 x 132	x
Loading Quantity 20 ft (Wrapped Carton)	pcs	408	408	x	x	408	408	x
Loading Quantity 40 ft (Wrapped Carton)	pcs	918	918	x	x	918	918	x
Loading Quantity 40 HC (Wrapped Carton)	pcs	1026	1026	x	x	1026	1026	x
Packed Product Dimensions (WxDxH) Box	mm	662 x 648 x 140 (default for glass lid option)	662 x 648 x 140 (default for glass lid option)	662 x 648 x 140	645 x 648 x 140	662 x 648 x 140 (default for glass lid option)	662 x 648 x 140 (default for glass lid option)	662 x 648 x 140
Loading Quantity 20 ft (Carton Box)	pcs	348	348	348	384	384	384	384
Loading Quantity 40 ft (Carton Box)	pcs	864	864	864	864	864	864	864
Loading Quantity 40 HC (Carton Box)	pcs	972	972	972	972	972	972	972
Net Weight (Depends on Model) Maximum	kg	13	13	14	15	13,5	13,5	14,5
Gross Weight (Depends on Model) Maximum	kg	14,25	14,25	15	16	14,75	14,75	15,5

SPECIFICATIONS

DOMINO HOB SPECIFICATION SHEET		Domino Gas Hobs	Domino Electric Hobs	Domino Gas Securit Hobs	Domino Vitro Ceramic Hobs	Domino Induction Ceramic Hobs
		30 CM	30 CM	30 CM	30 CM	30 CM
Available Colours						
White		-	-	Optional	Optional	Optional
Brown		-	-	-	-	-
Terre de France		-	-	-	-	-
Black		-	-	Standard	Standard	Standard
Dark Green		-	-	-	-	-
Stainless Steel		Standard	Standard	-	-	-
Product Dimensions						
Height (varies from model to model)	mm	42,5	42,5	47,5	47,5	56
Width	mm	290	290	290	290	290
Depth	mm	510	510	520	520	520
Cut-out Dimensions						
Width	mm	270	270	270	270	270
Depth	mm	490	490	490	490	490
Hob Features						
Hob		Stainless Steel	Stainless Steel	Securit	Vitro Ceramic	Induction Ceramic
Rapid Gas Burner Ø10cm	W	3000	-	3000	-	-
Semi-rapid Gas Burner Ø7.5cm	W	-	-	-	-	-
Auxiliary Gas Burner Ø5.5cm	W	1000	-	1000	-	-
Wok (Triple Flame) Gas Burner Ø14cm	W	3600	-	3600	-	-
Ø 145 mm Hotplate	W	-	1000	-	-	-
Ø 180 mm Hotplate	W	-	1500	-	-	-
Ø 145 mm Rapid Hotplate	W	-	-	-	-	-
Ø 180 mm Rapid Hotplate	W	-	2000	-	-	-
Ø145 mm Highlight Element	W	-	-	-	1200	-
Ø180 mm Highlight Element	W	-	-	-	1800	-
Ø210 mm Highlight Element	W	-	-	-	-	-
Ø180 mm Dual Element	W	-	-	-	1700	-
Ø145 mm Oval Element	W	-	-	-	-	-
Ø210 mm Dual Element	W	-	-	-	-	-
Ø210 mm Triple Element	W	-	-	-	-	-
Ø270 mm Triple Element	W	-	-	-	-	-
Rectangular Element	W	-	-	-	-	-
Ø 160 mm Induction Zone	W	-	-	-	-	Nominal 1400W max. Boost 1800W
Ø 200 mm Induction Zone	W	-	-	-	-	Nominal 2100W max. Boost 2500W
Oval Induction Zone						-
Boost Function						Standard
Pot Dedection						Standard
Automatic Heatup						Standard
Timer function for vitro ceramic hobs (If touch control with some hob configuration selected)						Standard
Child Lock for vitro ceramic hobs (If touch control selected)					Standard	Standard
Hot Surface Indicator Light					Standard	Standard
Hotplate Operation Indicator Light			Standard			
Side Knob Control			Standard			
Side Touch Control						
Front Knob Control		Standard		Standard	Standard	
Front Touch Control					Optional	Standard
Front Slim Touch Control						
Bevelled Edges					Optional	Optional
Logo		Standard	Standard	Optional	Optional	Optional
Special Decoration on Glass				Optional	Optional	Optional
Inox Frame				Optional	Optional	Optional
Stainless Steel Burner Pan				Optional		
Table Top Installation (not built-in)						
Glass Lid						
Burner Safety Valves		Optional		Optional		
Button Ignition		Optional				
One-touch-Ignition through knobs		Optional		Optional		
Enamel Pan Supports		Standard		Standard		
Cast Iron Pan Supports		Optional		Optional		
Cast Iron Burner Caps		Optional		Optional		
Coffee Adaptor		Optional		Optional		
Wok Adaptor		Optional		Optional		
Vitroceraamic Glass Cleaning Spatula					Optional	Optional
Gas Conversion Kit		Standard		Standard		
Gas Conversion Kit		Standard		Standard		
Others						
Total Power (Depends on Model) Maximum	kW	4	3,5	4	3	3,6
Voltage	V	230 V~	230 V~	230V~	230 V~	230 V~
RoHS Compliance		Standard	Standard	Standard	Standard	Standard
CE Compliance		Standard	Standard	Standard	Standard	Standard
Carton Box Packaging		Standard	Standard	Standard	Standard	Standard
Packed Product Dimensions (WxDxH)	mm	x	x	330 x 578 x 140	326 x 578 x 133	332 x 581 x 142
Packed Product Dimensions (WxDxH) Box	mm	331 x 566 x 143	331 x 566 x 143	x	x	x
Net Weight (Depends on Model) Maximum	kg	5,5	4,75	4,7	4,7	5,5
Gross Weight (Depends on Model) Maximum	kg	6	5,4	5	5	6,2
Container Loading Quantity (20 ft Container)	pcs	1190	1190	1088	1088	864
Container Loading Quantity (40 ft Container)	pcs	2499	2499	2304	2304	1920
Container Loading Quantity (40 ft HC Container)	pcs	2793	2793	2592	2592	2160

SPECIFICATIONS

POLY HOB SPECIFICATION SHEET	Electric Built-in Hob	Vitroceraamic Built-in Hob	Induction Built-in Hob	
	60cm	60cm	60cm	
Available Colours				
White	Standard	Optional	-	
Brown	Optional	-	-	
Terre de France	Optional	-	-	
Black	Optional	Standard	Standard	
Dark Green	Optional	-	-	
Stainless Steel	Optional	-	-	
Product Dimensions				
Height	mm	39	41	53
Width	mm	580	590	590
Depth	mm	510	520	520
Cut-out Dimensions				
Width	mm	560	560	560
Depth	mm	490	490	490
Hob Features				
Hob		Enamel	Vitroceraamic	Induction
Ø 145 mm Hotplate	W	1000	-	-
Ø 180 mm Hotplate	W	1500	-	-
Ø 145 mm Highlight Element	W	-	1200	-
Ø 180 mm Highlight Element	W	-	1800	-
Ø 180 mm Dual Element	W	-	1700	-
Ø 145 mm Oval Element	W	-	1800	-
Ø 210 mm Highlight Element	W	-	2300	-
Ø 145 mm Radiant Heating Element	W	-	1200	-
Ø 180 mm Radiant Heating Element	W	-	1700	-
Ø 160 mm Induction Zone	W	-	-	Nominal 1400 W max. Boost 1800 W
Ø 200 mm Induction Zone	W	-	-	Nominal 2100 W max. Boost 2500 W
Boost Function		-	-	Standard
Pot Dedection		-	-	Standard
Timer (If touch control and some hob configuration selected for vitroceraamic hob)		-	-	Standard
Child Lock (If touch control selected for vitroceraamic hob)		-	-	Standard
Hot Surface Indicator Light		-	Standard	Standard
Controls on the built-in oven panel		Standard	Standard	Standard
Controller		7 step switch	Energy Regulator/ 7 step switch (with radiant element)	Encoder
Hotplate Operation Indicator Light		Standard	-	-
Bevelled Edges		-	Optional	Optional
Logo		Standard	Optional	Optional
Special Artwork on Glass		-	Optional	Optional
STANDARD Vitroceraamic Glass Artwork		-	Slim Design Arc Design Point Design	Slim Design Arc Design Point Design
Inox Frame		-	Optional	Optional
Vitroceraamic Glass Cleaning Spatula		-	Optional	Optional
Others				
Total Power (Depends on Model) Maximum	kW	8,1	9,6	10,5
Voltage	V	230V~	230V~	230V~
RoHS Compliance		Standard	Standard	Standard
CE Compliance		Standard	Standard	Standard
Carton Box Packaging		Standard	Standard	Standard
Packed Product Dimensions (WxDxH)	mm	628x580x137	618x578x132	624x580x142
Net Weight (Depends on Model) Maximum	kg	8,75	7	11
Gross Weight (Depends on Model) Maximum	kg	9,5	8	12

75 It Built-in Oven Energy Class Declerations			
Model Description	Oven Function Designation	Available Energy Class Declerations	Function used for Energy Decleration
Static	(01/02/03/04/13/14/15)	A (yellow/white insulation)	Upper + Lower
Turbo Fan	(05/06/07/08/09/16/17/18/19/23/24/50/51/52/53)	A (yellow/white insulation) A+ (yellow/white insulation)	Fan + Ring
Fan assisted	(10/11/12/20/21/22/25/26)	A (yellow/white insulation)	Upper + Lower + Fan

*: Owner of this document is Vestel Beyaz Esya A.S.(VBE) . VBE has right to make changes on these values without notification by referring this document. - 14.05.2015

65 It Built-in Oven Energy Class Declerations			
Model Description	Oven Function Designation	Available Energy Class Declerations	Function used for Energy Decleration
Static	(01/02/03/04/13/14/15)	A (yellow/white insulation)	Upper + Lower
Turbo Fan	(05/06/07/08/09/16/17/18/19/23/24/50/51/52/53)	A (yellow/white insulation) A+ (yellow/white insulation)	Fan + Ring
Turbo Lite	(50/51)	A++ (yellow insulation with aluminium foil & Smart LCD Control)	Fan + Ring
Fan assisted	(10/11/12/20/21/22/25/26)	A (yellow/white insulation)	Upper + Lower + Fan











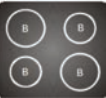

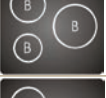
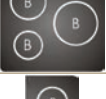

*: Owner of this document is Vestel Beyaz Esya A.S.(VBE) . VBE has right to make changes on these values without notification by referring this document. - 14.05.2015

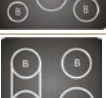
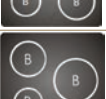

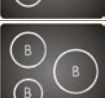





60 It Built-in Oven Energy Class Declerations			
Model Description	Oven Function Designation	Available Energy Class Declerations	Function used for Energy Decleration
Static	(01/02/03/04/13/14/15)	A (with/without cooling fan)	Upper + Lower
Turbo Fan	(05/06/07/08/09/16/17/18/19/23/24/27/28/29/50/51/52/53)	A (with cooling fan)	Fan + Ring
Fan assisted	(10/11/12/20/21/22/25/26)	A (with cooling fan)	Upper + Lower + Fan

*: Owner of this document is Vestel Beyaz Esya A.S.(VBE) . VBE has right to make changes on these values without notification by referring this document. - 14.05.2015

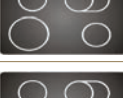
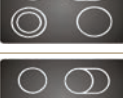
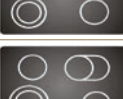
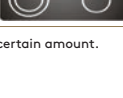
Electric Oven Function for Built-in Ovens						
Function ID	Identity in the Market	Heating Element, Fan, Turnspit, Grill Availability	Oven Functions	Electrical Power at 230V	Number of Functions	Limitations
01	Static oven	(Top + Bottom)	0/TOP+BOTTOM/BOTTOM/TOP	2300	3	-
02	Static oven	(Top + Bottom) + Grill + Turnspit	0/TOP+BOTTOM/BOTTOM/TOP/GRILL+TURNSPIT	2300	4	-
03	Static oven	(Top + Bottom) + Grill + Turnspit	0/TOP+BOTTOM/BOTTOM/GRILL+TURNSPIT/DOUBLE GRILL+TURNSPIT	2600	4	Not available for built-in oven without cooling fan
04	Static oven	(Top + Bottom) + Grill + Turnspit	0/OVENLIGHT/TOP+BOTTOM/BOTTOM/TOP/GRILL+TURNSPIT/DOUBLE GRILL+TURNSPIT	2600	6	Not available for built-in oven without cooling fan
06	FAN+RING oven	(Fan + Ring) + Grill + Turnspit	0/DEFROST/FAN+RING/GRILL+TURNSPIT/GRILL+FAN+TURNSPIT	2000	4	Not available for built-in oven without cooling fan
07	Multifunction oven	(Top + Bottom + Fan + Ring) + Grill + Turnspit	0/DEFROST/FAN+RING/TOP+BOTTOM/TOP+BOTTOM+FAN/GRILL+TURNSPIT/GRILL+FAN+TURNSPIT	2300	6	Not available for built-in oven without cooling fan
08	Multifunction oven	(Top + Bottom + Fan + Ring) + Grill + Turnspit	0/DEFROST/FAN+RING/TOP+BOTTOM/TOP+BOTTOM+FAN/GRILL+TURNSPIT/DOUBLE GRILL+TURNSPIT	2600	6	Not available for built-in oven without cooling fan
09	Multifunction oven	(Top + Bottom + Fan + Ring) + Grill + Turnspit	0/OVENLIGHT/DEFROST/FAN+RING/TOP+BOTTOM/TOP+BOTTOM+FAN/PIZZA/GRILL+TURNSPIT/DOUBLE GRILL+TURNSPIT/DOUBLE GRILL+FAN+TURNSPIT	3100	9	Not available for built-in oven without cooling fan
10	Fan assisted oven	(Top + Bottom + Fan) + Grill + Turnspit	0/DEFROST/TOP+BOTTOM/TOP+BOTTOM+FAN/GRILL+TURNSPIT/GRILL+FAN+TURNSPIT	2300	5	Not available for built-in oven without cooling fan
11	Fan assisted oven	(Top + Bottom + Fan) + Grill + Turnspit	0/DEFROST/TOP+BOTTOM/TOP+BOTTOM+FAN/GRILL+TURNSPIT/DOUBLE GRILL+TURNSPIT	2600	5	Not available for built-in oven without cooling fan
12	Fan assisted oven	(Top + Bottom + Fan) + Grill + Turnspit	0/OVENLIGHT/DEFROST/TOP+BOTTOM/TOP+BOTTOM+FAN/BOTTOM+FAN/GRILL+TURNSPIT/DOUBLE GRILL+TURNSPIT/DOUBLE GRILL+FAN+TURNSPIT	2600	8	Not available for built-in oven without cooling fan
13	Static oven	(Top + Bottom) + Grill	0/TOP+BOTTOM/BOTTOM/TOP/GRILL	2300	4	-
14	Static oven	(Top + Bottom) + Grill	0/TOP+BOTTOM/BOTTOM/GRILL/DOUBLE GRILL	2600	4	Not available for built-in oven without cooling fan
15	Static oven	(Top + Bottom) + Grill	0/OVENLIGHT/TOP+BOTTOM/BOTTOM/TOP/GRILL/DOUBLE GRILL	2600	6	Not available for built-in oven without cooling fan
16	FAN+RING oven	(Fan + Ring) + Grill	0/DEFROST/FAN+RING/GRILL/GRILL+FAN	2000	4	Not available for built-in oven without cooling fan
17	Multifunction oven	(Top + Bottom + Fan + Ring) + Grill	0/DEFROST/FAN+RING/TOP+BOTTOM/TOP+BOTTOM+FAN/GRILL/GRILL+FAN	2300	6	Not available for built-in oven without cooling fan
18	Multifunction oven	(Top + Bottom + Fan + Ring) + Grill	0/DEFROST/FAN+RING/TOP+BOTTOM/TOP+BOTTOM+FAN/GRILL/DOUBLE GRILL	2600	6	Not available for built-in oven without cooling fan
19	Multifunction oven	(Top + Bottom + Fan + Ring) + Grill	0/OVENLIGHT/DEFROST/FAN+RING/TOP+BOTTOM/TOP+BOTTOM+FAN/PIZZA/GRILL/DOUBLE GRILL/DOUBLE GRILL+FAN	3100	9	Not available for built-in oven without cooling fan
20	Fan assisted oven	(Top + Bottom + Fan) + Grill	0/DEFROST/TOP+BOTTOM/TOP+BOTTOM+FAN/GRILL/GRILL+FAN	2300	5	Not available for built-in oven without cooling fan
21	Fan assisted oven	(Top + Bottom + Fan) + Grill	0/DEFROST/TOP+BOTTOM/TOP+BOTTOM+FAN/GRILL/DOUBLE GRILL	2600	5	Not available for built-in oven without cooling fan
22	Fan assisted oven	(Top + Bottom + Fan) + Grill	0/OVENLIGHT/DEFROST/TOP+BOTTOM/TOP+BOTTOM+FAN/BOTTOM+FAN/GRILL/DOUBLE GRILL/DOUBLE GRILL+FAN	2600	8	Not available for built-in oven without cooling fan
23	Multifunction oven	(Top + Bottom + Fan + Ring)	0/DEFROST/FAN+RING/TOP+BOTTOM/TOP+BOTTOM+FAN	2300	4	Not available for built-in oven without cooling fan
24	Multifunction oven	(Top + Bottom + Fan + Ring) + Turnspit	0/DEFROST/FAN+RING+TURNSPIT/TOP+BOTTOM+TURNSPIT/TOP+BOTTOM+FAN+TURNSPIT	2300	4	Not available for built-in oven without cooling fan
25	Fan assisted oven	(Top + Bottom + Fan)	0/DEFROST/TOP+BOTTOM/TOP+BOTTOM+FAN	2300	3	Not available for built-in oven without cooling fan
26	Fan assisted oven	(Top + Bottom + Fan) + Turnspit	0/DEFROST/TOP+BOTTOM+TURNSPIT/TOP+BOTTOM+FAN+TURNSPIT	2300	3	Not available for built-in oven without cooling fan
27	Fan assisted oven	(Top + Bottom + Fan) + Grill	0/DEFROST/TOP+BOTTOM/TOP+BOTTOM+FAN/GRILL/DOUBLE GRILL/PYROLYSIS	2600	6	Available for only pyrolytic oven
28	Multifunction oven	(Top + Bottom + Fan + Ring) + Grill	0/DEFROST/FAN+RING/TOP+BOTTOM/TOP+BOTTOM+FAN/GRILL/DOUBLE GRILL/DOUBLE GRILL + FAN/PYROLYSIS	2600	8	Available for only pyrolytic oven
29	Multifunction oven	(Top + Bottom + Fan + Ring) + Grill + Turnspit	0/DEFROST/FAN+RING/TOP+BOTTOM/TOP+BOTTOM+FAN/GRILL+TURNSPIT/DOUBLE GRILL+TURNSPIT/DOUBLE GRILL+FAN+TURNSPIT/PYROLYSIS	2600	8	Available for only pyrolytic oven
50	Multifunction oven	(Top + Bottom + Fan + Ring) + Grill + Turnspit	0/OVENLIGHT/DEFROST/FAN+RING/TOP+BOTTOM/TOP+BOTTOM+FAN/PIZZA/GRILL + TURNSPIT/DOUBLE GRILL+TURNSPIT/DOUBLE GRILL+FAN + TURNSPIT/VAP CLEAN	3100	10	Not available for built-in oven without cooling fan
51	Multifunction oven	(Top + Bottom + Fan + Ring) + Grill	0/OVENLIGHT/DEFROST/FAN+RING/TOP+BOTTOM/TOP+BOTTOM+FAN/PIZZA/GRILL/DOUBLE GRILL/DOUBLE GRILL+FAN/VAP CLEAN	2300	10	Not available for built-in oven without cooling fan
52	Fan assisted oven	(Top + Bottom + Fan) + Grill	0/DEFROST/BOTTOM/TOP+BOTTOM/TOP+BOTTOM+FAN/GRILL/GRILL+FAN	2300	6	Not available for built-in oven without cooling fan
53	Fan assisted oven	(Top + Bottom + Fan)	0/BOTTOM/TOP+BOTTOM/TOP+BOTTOM+FAN	2300	4	Not available for built-in oven without cooling fan
54	Fan assisted oven	(Top + Bottom + Fan + Ring) + Grill + Turnspit	0/DEFROST/BOTTOM/TOP+BOTTOM/TOP+BOTTOM+FAN/GRILL+TURNSPIT/GRILL+FAN+TURNSPIT	2600	7	Not available for built-in oven without cooling fan
55	Fan assisted oven	(Top + Bottom + Fan) + Turnspit	0/BOTTOM/TOP+BOTTOM+TURNSPIT/TOP+BOTTOM+FAN+TURNSPIT	2300	5	Not available for built-in oven without cooling fan
56	Multifunction oven	(Top + Bottom + Fan + Ring) + Grill + Turnspit	0/OVENLIGHT/DEFROST/FAN+RING/TOP+BOTTOM/TOP+BOTTOM+FAN/PIZZA/GRILL/DOUBLE GRILL/DOUBLE GRILL+FAN/VAP CLEAN+/STEAM AID COOKING	3100	12	Not available for built-in oven without cooling fan

SPECIFICATIONS

Induction Hob Configurations for Built-in Hobs and Polyvalente Hobs					
HOB ID	CONFIGURATION	LIMITATIONS	ELEMENT PLACEMENT	GENERATION	CONTROL SYSTEM
18	2 x 160mm, 1400/1800W induction element 2 x 200mm, 2100/2500W induction element	Available for both 60cm and 78cm		VESTEL SERI 1	STANDARD
19	2 x 160mm, 1400/1800W induction element 2 x 200mm, 2100/2500W induction element with timer	Available for both 60cm and 78cm		VESTEL SERI 1	STANDARD OR SLIDER CONTROL
20	2 x 160mm, 1400/1800W induction element 2 x 200mm, 2100/2500W induction element with timer	Available only for POLYVALENTE		VESTEL SERI 1	KNOB CONTROL
20	1 x 160mm, 1400/1800W induction element 2 x 200mm, 2100/2500W induction element	Available only for 60cm		VESTEL SERI 1	STANDARD
21	1 x 160mm, 1400/1800W induction element 2 x 200mm, 2100/2500W induction element with timer	Available only for 60cm		VESTEL SERI 1	STANDARD OR SLIDER CONTROL
22	1 x 160mm, 1400/1800W induction element 1 x 200mm, 2100/2500W induction element 1 x 250mm, 2800/3500W induction element	Available only for 60cm		VESTEL SERI 1	STANDARD
23	1 x 160mm, 1400/1800W induction element 1 x 200mm, 2100/2500W induction element 1 x 250mm, 2800/3500W induction element with timer	Available only for 60cm		VESTEL SERI 1	STANDARD OR SLIDER CONTROL
24	2 x 160mm, 1400/1800W induction element 1 x 200mm, 2100/2500W induction element	Available only for 30cm		VESTEL SERI 1	STANDARD
25	3 x 160mm, 1400/1800W induction element 1 x 200mm, 2100/2500W induction element with timer	Available only for 30cm		VESTEL SERI 1	STANDARD
26	2 x 160mm, 1400/1800W induction element 2 x 200mm, 2100/2500W induction element 1 x 250mm, 2800/3500W induction element with timer	Available only for 90cm		VESTEL SERI 1	STANDARD
27	3 x 160mm, 1400/1800W induction element 1 x 200mm, 2100/2500W induction element bridge zone, mode function, timer	Available only for 60cm		VESTEL SERI 1	STANDARD
28	1 x 160mm, 1400/1800W induction element 2 x 210mm, 2100/2500W induction element	Available only for 60cm		VESTEL SERI 2	STANDARD
29	1 x 160mm, 1400/1800W induction element 2 x 210mm, 2100/2500W induction element with timer	Available only for 60cm		VESTEL SERI 2	STANDARD OR SLIDER CONTROL
30	1 x 160mm, 1400/1800W induction element 1 x 210mm, 2100/2500W induction element 1 x 290mm, 2800/3500W induction element	Available only for 60cm		VESTEL SERI 2	STANDARD
31	1 x 160mm, 1400/1800W induction element 1 x 210mm, 2100/2500W induction element 1 x 290mm, 2800/3500W induction element with timer	Available only for 60cm		VESTEL SERI 2	STANDARD OR SLIDER CONTROL
32	2 x 160mm, 1400/1800W induction element 2 x 210mm, 2100/2500W induction element	Available only for 60cm		VESTEL SERI 2	STANDARD
33	2 x 160mm, 1400/1800W induction element 2 x 210mm, 2100/2500W induction element with timer	Available only for 60cm		VESTEL SERI 2	STANDARD OR SLIDER CONTROL
34	2 x 160mm, 1400/1800W induction element 1 x 290mm, 2800/3500W induction element with timer	Available only for 60cm		VESTEL SERI 2	STANDARD OR SLIDER CONTROL
35	3 x 160mm, 1400/1800W induction element 1 x 200mm, 2100/2500W induction element bridge zone, mode function, timer	Available only for 60cm		VESTEL SERI 2	STANDARD OR SLIDER CONTROL

78cm Vitroceramic Hob Configurations			
HOB ID	Highlight Element Configuration	ELEMENT PLACEMENT	CONTROL SYSTEM
1	2 x 145 Highlight, 1 x oval, 1 x 180 highlight element		STANDARD
*2	2 x 145 Highlight, 1 x oval, 1 x 180 highlight element with timer		
3	2 x 145 Highlight, 1 x dual, 1 x 210 highlight element		STANDARD
*4	2 x 145 Highlight, 1 x dual, 1 x 210 highlight element with timer		
*5	2 x 145 Highlight, 1 x 210, 1 x oval highlight element		
*6	2 x 145 Highlight, 1 x 210, 1 x oval highlight element with timer		
9	1 x 145 Highlight, 1 x 180, 1 x dual, 1 x oval highlight element		STANDARD
10	1 x 145 Highlight, 1 x 180, 1 x dual, 1 x oval highlight element with timer		STANDARD OR SLIDER CONTROL
*11	2 x 145 Highlight, 1 x dual, 1 x oval highlight element		
*12	2 x 145 Highlight, 1 x dual, 1 x oval highlight element with timer		
*13	2 x 145 Highlight, 1 x 210 dual, 1 x oval highlight element		
*14	2 x 145 Highlight, 1 x 210 dual, 1 x oval highlight element with timer		

*: Available upon request with warranty of a certain amount.

60cm Vitroceramic Hob with Front Triangular Touch Control (FRTR)			
HOB ID	CONFIGURATION	ELEMENT PLACEMENT	CONTROL SYSTEM
1	2 x 145, 2 x 180 highlight element		STANDARD OR SLIDER CONTROL
2	2 x 145, 1 x 180, 1 x 180 dual highlight element		STANDARD
3	2 x 145, 1 x 180, 1 x 210 highlight element		STANDARD OR SLIDER CONTROL
4	2 x 145, 1 x 210, 1 x 180 dual highlight element		STANDARD
5	2x145,1x180,1xoval highlight		STANDARD
6	2 x 145, 1 x 180 dual, 1 x oval highlight element		STANDARD OR SLIDER CONTROL
7*	2 x 145, 1 x 210, 1 oval highlight element		STANDARD
8	2 x 145, 1 x 180, 1 x 180 dual highlight element with timer		STANDARD
9	2 x 145, 1 x 180 dual, 1 x oval highlight element with timer		STANDARD
10	2 x 145, 1 x 180, 1 x 210 triple highlight element with timer		STANDARD OR SLIDER CONTROL
13	1 x 145, 1 x 180, 1 x 290 triple highlight element		STANDARD
14*	2 x 145, 1 x 210 dual, 1 x 180 dual highlight element		STANDARD
15*	2 x 145, 1 x 210 dual, 1 x 180 dual highlight element with timer		STANDARD
22*	1x145, 1x180, 1x210 highlight element		STANDARD
23*	1x145, 1x180, 1x210 dual highlight element		STANDARD
24*	1x145, 2x180 highlight element		STANDARD
25	1 x 145, 1 x 180, 1 x 290 dual highlight element		STANDARD
26	1 x 145, 1 x 180, 1 x 290 dual highlight element with timer		STANDARD OR SLIDER CONTROL
27	2 x 145, 2 x 180 highlight element, timer		STANDARD
35	1 x 145, 1 x 180, 1x290 highlight element, timer		SLIDER CONTROL

*Available upon request

60cm Vitroceramic Hob for Combi Built-in Oven (POLY)			
HOB ID	CONFIGURATION	ELEMENT PLACEMENT	CONTROL SYSTEM
4	2 x 145, 2 x 180 highlight element (U shape order_145-180-145-180)		None
5*	2 x 145, 1 x 180, 1 x 180 dual highlight element (U shape order_145 - 180dual - 145 - 180)		None
8*	2 x 145, 1 x oval, 1 x 210 dual highlight element (U shape order_145 - 210dual - 145 - oval)		None
9	2 x 145, 1 x 180 dual, 1 x oval highlight element (U shape order_145 - 180dual - 145 - oval)		None
10*	2 x 145, 1 x 180, 1 x oval highlight element (U shape order_145 - 180 - 145 - oval)		None
11	2 x 145, 1 x 180, 1 x 210 highlight element (U shape order_145 - 210 - 145 - 180)		None
12*	2 x 145, 1 x 210, 1 x 180 dual highlight element (U shape order_145 - 210 - 145 - 180dual)		None
13*	2 x 145, 1 x 210, 1 oval highlight element (U shape order_145 - 210 - 145 - oval)		None
14*	2 x 145, 1 x oval, 1 x 210 dual highlight element (U shape order_145 - 210dual - 145 - oval)		None

*Available upon request

60cm Vitroceramic Hob with Side Knob Control (SDKB)			
HOB ID	CONFIGURATION	ELEMENT PLACEMENT	LIMITATIONS
1	2 x 145, 2 x 180 highlight element		None
2	2 x 145, 1 x 180, 1 x 180 dual highlight element		None
3	2 x 145, 1 x 180, 1 x 210 highlight element		None
4	2 x 145, 1 x 210, 1 x 180 dual highlight element		None
5*	2 x 145, 1 x 180, 1 x oval highlight element		None
6*	2 x 145, 1 x 180 dual, 1 x oval highlight element		None
7	2 x 145, 1 x 210, 1 oval highlight element		None

*Available upon request

SPECIFICATIONS

60cm Side Controlled Solid Hotplate and Polyvalente Built-in Electric Hob Configurations			
HOB ID	CONFIGURATION	LIMITATIONS	ELEMENT PLACEMENT
01	2 x 145, 2 x 180 hotplate	None	
02	2 x 145, 1 x 180, 1 x 180 rapid hotplate	None	
03	1 x 145, 1 x 145 rapid, 1 x 180, 1 x 180 rapid hotplate	Not available for polyvalente type hob	
*04	1 x 145, 1 x 145 rapid, 2 x 180 hotplate	Not available for polyvalente type electric hob	

60CM SIDE CONTROLLED SOLID HOTPLATE HOBS ARE AVAILABLE FOR TABLE TOP
*: Available upon request with warranty of a certain amount.

60cm Side Controlled Gas Hob Configurations			
HOB ID	CONFIGURATION	LIMITATIONS	ELEMENT PLACEMENT
31	1 x Auxiliary, 1 x Semi Rapid, 1 x Rapid Burner, 1 x Hotplate	Not available for gas on glass hob	
40	1 x Auxiliary, 2 x Semi Rapid, 1 x Rapid Burner	None	
41	1 x Auxiliary, 2 x Semi Rapid, 1 x Triple Flame Burner	None	

60CM SIDE CONTROLLED GAS HOBS ARE AVAILABLE FOR TABLE TOP APPLICATION

60cm Front Controlled Gas Hob Configurations			
HOB ID	CONFIGURATION	LIMITATIONS	ELEMENT PLACEMENT
31	1 x Auxiliary, 1 x Semi Rapid, 1 x Rapid Burner, 1 x Hotplate	Model I not available for gas on glass hob	
40	1 x Auxiliary, 2 x Semi Rapid, 1 x Rapid Burner	None	
41	1 x Auxiliary, 2 x Semi Rapid, 1 x Triple Flame Burner	None	

60cm Pure Design Combined Hobs Configurations			
HOB ID	CONFIGURATION	LIMITATIONS	ELEMENT PLACEMENT
62	2 Gas Heaters (1 x Rapid & 1 x Semi Rapid) 2 Hilight Heaters (1X180 & 1X145)	Available for only side knob control	
64	2 Gas Heaters (1 x Rapid & 1 x Auxiliary) 2 Hilight Heaters (1X180 & 1X145)	Available for only side knob control	
66	3 Gas Heaters (1 x Semi Rapid & 1 x Auxiliary & 1 x Rapid) 1 Hilight Heater (1X180)	Available for only side knob control	
67	3 Gas Heaters (1 x Semi Rapid & 1 x Auxiliary & 1 x Rapid) 1 Hilight Heater (1X180 DUAL)	Available for only side knob control	
69	2 Gas Heaters (1 x Rapid & 1 x Semi Rapid) 2 Induction Heaters with timer 1X200 (Nominal 2100W max.Boost 2500W) 1X160 (Nominal 1400W max.Boost 1800W)	Available for only side control. Touch control is standard for induction heaters, knob control is standard for gas heaters.	

90cm Front Controlled Gas Hob Configurations			
HOB ID	CONFIGURATION	LIMITATIONS	ELEMENT PLACEMENT
51	1 x Auxiliary, 2 x Semi Rapid, 1 x Rapid, 1 x Triple Flame Burner (MONO)	None	
53	2 x Auxiliary, 2 x Semi Rapid, 1 x Rapid, 1 x Triple Flame Burner (DUAL)	None	

70cm Front Controlled Gas Hob Configurations			
HOB ID	CONFIGURATION	LIMITATIONS	ELEMENT PLACEMENT
50	1 x Auxiliary, 2 x Semi Rapid, 2 x Rapid Burner	Not available for Plus x	
51	1 x Auxiliary, 2 x Semi Rapid, 1 x Rapid, 1 x Triple Flame Burner	None	

30cm Gas On Glass Hob Configurations		
HOB ID	CONFIGURATION	ELEMENT PLACEMENT
10	1 x Triple Flame Burner	
20	1 x Auxiliary, 1 x Rapid Burner	

30cm Induction Hob Configurations		
HOB ID	CONFIGURATION	ELEMENT PLACEMENT
24	1 x 160 mm, 1400/B1800W induction element 1 x 200 mm, 2100/B2500W induction element	
25	1 x 160 mm, 1400/B1800W induction element 1 x 200 mm, 2100/B2500W induction element with timer	

SPECIFICATIONS

30cm Solid Hotplate Hob Configurations			
HOB ID	CONFIGURATION	ELEMENT PLACEMENT	LIMITATIONS
05	1 x 145, 1 x 180 hotplate		None
*06	1x145 rapid hotplate, 1x180 rapid hotplate		
*07	1x145rapid hotplate, 1x180 hotplate		
08	1x145 hotplate, 1x180 rapid hotplate		None

*: Available upon request with warranty of a certain amount.













30cm Vitroceramic Hob Configurations		
HOB ID	CONFIGURATION	ELEMENT PLACEMENT
16	1 x 180 Highlight, 1 x 145 Highlight element	
17	1 x 180 Dual, 1 x 145 Highlight element	
19	1 x 180 Highlight, 1 x 145 Highlight element with timer	
20	1 x 180 Dual, 1 x 145 Highlight element with timer	

ALL ELEMENT CONFIGURATIONS ARE APPLICABLE FOR BOTH KNOB CONTROL AND TOUCH CONTROL UNIT



































	Add-on Types for Built-in Cookers							
	I Type Add_on		U Type Add_on		O Type		Mono Stripe	
	Inox Control Panel	Glass Control Panel	Inox Control Panel	Glass Control Panel	Inox Control Panel	Glass Control Panel	Inox Control Panel	Glass Control Panel
17 mm					N/A	N/A		
	Laser Cut	Laser Cut	Laser Cut	Laser Cut			Cladding or Laser Cut	Cladding or Laser Cut
50 mm								
	Cladding	Cladding	Cladding or Laser Cut	Cladding or Laser Cut	Laser Cut	Cladding or Laser Cut	Cladding or Laser Cut	Cladding or Laser Cut
65 mm					N/A	N/A	N/A	N/A
	Cladding	Cladding	Cladding	Cladding				
80 mm	N/A	N/A	N/A	N/A	N/A	N/A		
							Laser Cut	Laser Cut

















DUO Stripe	TRIO Stripe	CORNER	LED Full Touch	VISIO Touch	Rustic
Glass Control Panel	Glass Control Panel	Glass Control Panel	Glass Control Panel	Glass Control Panel	Glass Control Panel
Laser Cut	Laser Cut	Laser Cut	Laser Cut	Laser Cut	Cladding















SPECIFICATIONS

	Add-on Types for Built-in Cookers							
	I Type Add_on		U Type		O Type		Mono Stripe	
	Inox Control Panel	Glass Control Panel	Metal Control Panel	Glass Control Panel	Metal Control Panel	Glass Control Panel	Metal Control Panel	Glass Control Panel
17 mm	N/A	N/A			N/A	N/A	N/A	N/A
			Laser Cut	Laser Cut				
40 mm								
	Cladding	Cladding	Cladding	Cladding	Cladding	Cladding		
50 mm	N/A	N/A	N/A	N/A	N/A	N/A		
							Laser Cut	Laser Cut













DUO Stripe	TRIO Stripe
Glass Control Panel	Glass Control Panel
	
Laser Cut	Laser Cut









SIDE CONTROLLED HOBS	ENAMELLED PAN SUPPORTS					CAST IRON PAN SUPPORTS				
	S-type	V-type	O-type	K-type	D-type	S-type Cast Iron	W-type Cast Iron	K-type Cast Iron	Extenda Cast Iron	
	0°	0°	45°	45°	0°	0°	45°	45°	0°	
FLAT (R, S type)								N/A	N/A	N/A
FLAT (T type)								N/A	N/A	
SURFACE								N/A	N/A	N/A
SMOOTHLINE				N/A	N/A		N/A	N/A	N/A	N/A
NEW FREESTANDING								N/A	N/A	N/A
DIVISION		N/A	N/A	N/A	N/A	N/A		N/A	N/A	N/A



		ENAMELLED PAN SUPPORTS					CAST IRON PAN SUPPORTS				
		S-type	V-type	O-type	K-type	D-type	S-type Cast Iron	W-type Cast Iron	K-type Cast Iron	Extenda Cast Iron	
		0°	0°	45°	45°	0°	0°	45°	45°	0°	
FRONT CONTROLLED HOBS	30 cm Domino			N/A	N/A	N/A	N/A		N/A	N/A	N/A
	60 cm Model1			N/A	N/A		N/A	N/A		N/A	
	70 cm Model1			N/A	N/A	N/A	N/A	N/A		N/A	
	60 cm Plusx			N/A	N/A	N/A	N/A		N/A	N/A	N/A
	70 cm Plusx			N/A	N/A	N/A	N/A		N/A	N/A	N/A

		ENAMELLED PAN SUPPORTS					CAST IRON PAN SUPPORTS			
		Mono, Standard	Mono, Plusx	Mono, Profile	Mono Cast Iron	Mono Cast, Plusx	Line Cast Iron	Deluxe Cast Iron	S-type Cast Iron	
										
		45°	45°	45°	45°	45°	0°	45°	0°	
SIDE CONTROLLED GAS SECURIT HOBS	SECURIT II 4G		✓	✓	✓	✓	✓	N/A	N/A	N/A
	SECURIT II		✓	✓	✓	✓	N/A	N/A	N/A	N/A
	SECURIT II TRIO		✓	✓	✓	N/A	✓	N/A	N/A	N/A
	PURE DESIGN 2GAS+2 VITRO		✓	✓	✓	✓	✓	N/A	N/A	N/A
	PURE DESIGN 3GAS+1 VITRO		✓	✓	✓	✓	✓	N/A	N/A	N/A
	PURE DESIGN 2GAS+2 IND		✓	✓	✓	✓	✓	N/A	N/A	N/A
	DIVISION		N/A	N/A	N/A	N/A	N/A	N/A	N/A	✓

SPECIFICATIONS

		ENAMELLED PAN SUPPORTS					CAST IRON PAN SUPPORTS				
		Lama Mono, STANDARD	Plusx Mono, Plusx	Mono, Profile	Mono Cast Iron	Mono Cast, Plusx	Line Cast Iron	Deluxe Cast Iron	S-type Cast Iron	S-type Cast Iron	
											
		45°	45°	45°	45°	45°	0°	45°	0°	0°	
FRONT CONTROLLED GAS SECURIT HOBS	SECURIT 30 cm DOMINO 	A	A	A	N/A for Wok	A	N/A	N/A	N/A	N/A	
	SECURIT 60/70 cm MODEL 1 	A	A	A	A	N/A	N/A	N/A	N/A	N/A	
	SECURIT 60/70 cm PLUSX 	A	A	A	A	A	A	N/A	N/A	N/A	
	SECURIT 90 cm 	N/A	N/A	N/A	N/A	N/A	N/A	N/A	N/A	A	

Knob Limitation Table Built-in Cookers					
		BUILT-IN	Side Controlled HOB	Front Controlled HOB	DOMINO S-I /S-II
ALFA		✓	✓	✓	✓
ANTERO		✓	Knob with ring Not applicable to Hob range	Knob with ring Not applicable to Hob range	Knob with ring Not applicable to Hob range
BUYUK ANTERO		✓	✓	✓	✓
BIG MACRO RING		✓	Knob with ring Not applicable to Hob range	Knob with ring Not applicable to Hob range	Knob with ring Not applicable to Hob range
BIG MACRO		✓	✓	✓	Not suitable for Domino range. (Alternative - Small Macro)
BIG RIMO		✓	✓	✓	✓
BIG TRIO		✓	✓	✓	✓
DELTA		✓	✓	✓	✓
DELTA RING		✓	Knob with ring Not applicable to Hob range	Knob with ring Not applicable to Hob range	Knob with ring Not applicable to Domino range
ECLIPSE		✓	✓	✓	✓
ECLIPSE RING		✓	Knob with ring Not applicable to Hob range	Knob with ring Not applicable to Hob range	Knob with ring Not applicable to Domino range
EPSILON		✓	Knob with ring It's not applicable to Hob range	Knob with ring It's not applicable to Hob range	Knob with ring Not applicable to Domino range
FEROUS		✓	No use	No use	No use
GAMA		✓	✓	Height of knob is not suitable for FC range	✓
GAMA RING		✓	Knob with ring Not applicable to Hob range	Knob with ring Not applicable to Hob range	Knob with ring Not applicable to Domino range
JANNU		✓	✓	✓	✓
JANNU RING		✓	Knob with ring Not applicable to Hob range	Knob with ring Not applicable to Hob range	Knob with ring Not applicable to Hob range

Knob Limitation Table Built-in Cookers					
		BUILT-IN	Side Controlled HOB	Front Controlled HOB	DOMINO S-I /S-II
NORD		✓	✓	Height of knob is not suitable for FC range	✓
NORD RING		✓	Knob with ring Not applicable to Hob range	Knob with ring Not applicable to Hob range	Knob with ring Not applicable to Domino range
OMEGA		✓	Knob with ring Not applicable to Hob range	Knob with ring Not applicable to Hob range	Knob with ring Not applicable to Domino range
PIPO		✓	Pop in-Pop out mechanism is not available for Hob range.	Pop in-Pop out mechanism is not available for Hob range.	Pop in-Pop out mechanism is not available for Domino range.
RIMO		✓	Knob with ring Not applicable to Hob range	Knob with ring Not applicable to Hob range	Knob with ring Not applicable to Domino range
RUSTIC RISUS (without ring)		✓	✓	Height of knob is not suitable for FC range	✓
RUSTIC RISUS (with ring)		✓	Knob with ring Not applicable to Hob range	Knob with ring Not applicable to Hob range	Knob with ring Not applicable to Domino range
SMALL MACRO (with ring)		✓	Knob with ring Not applicable to Hob range	Knob with ring Not applicable to Hob range	Knob with ring Not applicable to Domino range
SMALL MACRO (without ring)		✓	Not suitable for Hob range. (Alternative - Big Macro)	Not suitable for Hob range. (Alternative - Big Macro)	✓
SPECTRUM		✓	Knob with ring Not applicable to Hob range	Knob with ring Not applicable to Hob range	Knob with ring Not applicable to Domino range
TRIO		✓	Knob with ring Not applicable to Hob range	Knob with ring Not applicable to Hob range	Knob with ring Not applicable to Domino range
VESTA		✓	✓	Height of knob is not suitable for FC range	✓
VARIO		✓	✓	✓	✓
VARIO RING		✓	Knob with ring Not applicable to Hob range	Knob with ring Not applicable to Hob range	Knob with ring Not applicable to Domino range
ZENITH		✓	No use	No use	No use
ZETA		✓	✓	✓	✓
ZETA RING		✓	No use	No use	No use

INSTALLATION OF 60 CM BUILT-IN OVEN

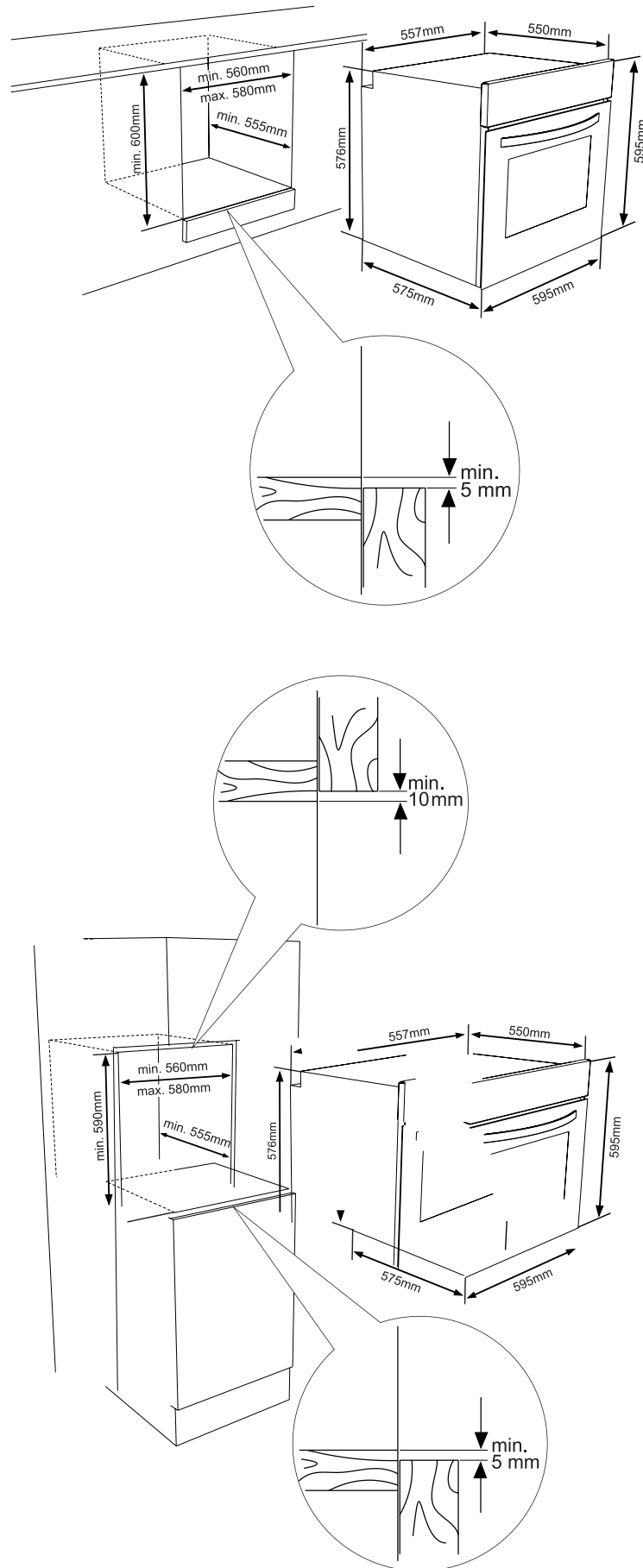

INSTALLATION OF 60 CM BUILT-IN OVEN

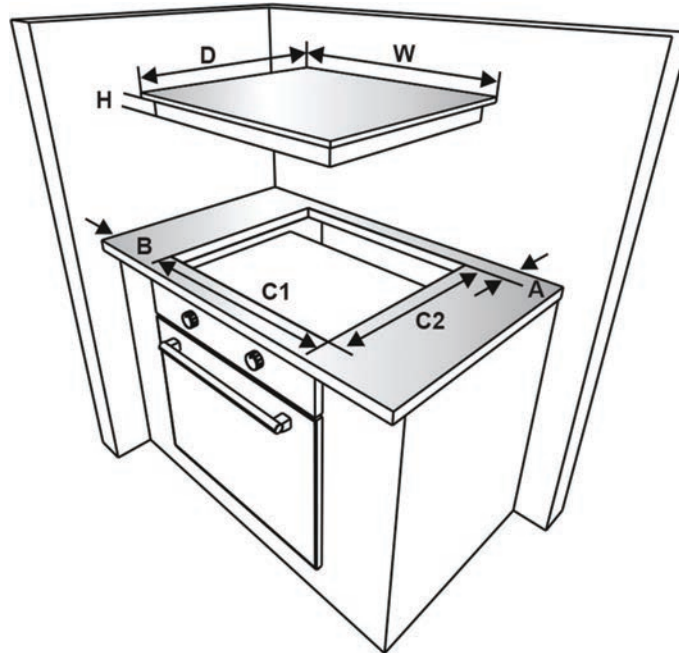

Installation dimensions for hob

	Vitroc ceramic	Induction	Hotplate
A1 (mm)	590	590	580
B1 (mm)	520	520	510
C1 (mm)	41	56	40
D1 (mm)	560	560	560
E1 (mm)	490	490	490
F1 (mm)	min. 50	min. 50	min. 50
G1 (mm)	min. 50	min. 50	min. 50

Installation dimensions for oven

A2 (mm)	557	G2 (mm)	min. 555
B2 (mm)	550	H2 (mm)	590
C2 (mm)	595	I2 (mm)	600
D2 (mm)	575	J2 (mm)	25
E2 (mm)	576	K2 (mm)	2
F2 (mm)	min. 560-580		

INSTALLATION OF POLYVALENTE BUILT-IN COOKER SET

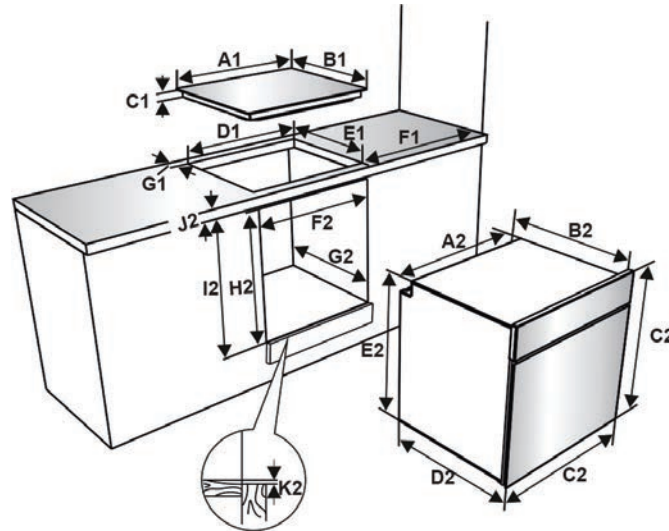

Product Types	Size	Aesthetic	W (mm)	D (mm)	H (mm)	C1 (mm)	C2 (mm)	A (mm)	B (mm)
BI Gas/Combined Hobs	60 cm	Flat/Surface	580	510	40	560	490	50	100
	60 cm	Extenda	580	510	40	560	490	50	100
	60 cm	Classic	580	510	40	560	490	50	100
	60 cm	Model 1	590	515	40	560	490	50	100
	60 cm	PlusX	580	515	42	560	490	50	100
	60 cm	Division	580	510	42	560	490	50	100
	70 cm	Model 1	680	515	40	560	490	50	150
	70 cm	PlusX	700	515	42	560	490	50	150
BI Gas on Glass Hobs	60 cm	Securit 2	594	523	44	560	490	50	100
	60 cm	Trio	594	523	44	560	490	50	100
	60 cm	Model 1	590	515	40	560	490	50	100
	60 cm	PlusX	594	523	44	560	490	50	100
	60 cm	Division	594	523	44	560	490	50	100
	70 cm	Model 1	680	515	40	560	490	50	150
	70 cm	PlusX	700	520	44	560	490	50	150
BI Gas & Ceramic on Glass Hobs	60 cm	Pure, 2gas+2highlight	590	520	52	560	490	50	100
	60 cm	Pure, 3gas+1highlight	590	520	52	560	490	50	100
	60 cm	Pure, 2gas+2induction	590	520	52	560	490	50	100
BI Electric Hobs	60 cm	Flat/Surface	580	510	40	560	490	50	50
BI Vitro Ceramic Hobs	60 cm	C Serie	590	520	41- 47,5	560	490	50	50
	78 cm	C Serie	780	520	41	750	490	50	50
BI Induction Ceramic Hobs	60 cm	Vestel Induction	590	520	56	560	490	50	50
	78 cm	Vestel Induction	780	520	56	750	490	50	50
	90 cm	Vestel Induction	890	520	56	860	490	50	50
Domino Gas Hobs	30 cm	Gas Serie 2	510	290	42,5	270	490	50	100
Domino Electric Hobs	30 cm	Electric Serie 2	510	290	42,5	270	490	50	50
Domino Gas on Glass Hobs	30 cm	Securit Serie 1	520	290	47,5	270	490	50	100
	30 cm	Securit Serie 2	510	290	47,5	270	490	50	100
Domino Vitro Ceramic Hobs	30 cm	Vitro Ceramic Serie 1	520	290	47,5	270	490	50	50
	30 cm	Vitro Ceramic Serie 2	510	290	47,5	270	490	50	50
Domino Induction Ceramic Hobs	30 cm	Vestel Induction Serie 1	520	290	56	270	490	50	50
	30 cm	Vestel Induction Serie 2	510	290	56	270	490	50	50

Vestel Trade Co.

Organize Sanayi Bölgesi, 45030 Manisa/Türkiye

Phone: 90 - 236 233 25 82

Fax: 90 - 236 233 25 84

vesteltrade@vestel.com.tr

www.vestel.com.tr

Vestel Benelux B.V.

Stationsplein 45,

Groothandelsgebouw A194,

3013 AK Rotterdam,

The Netherlands

Phone: 31 - 10 235 1000

info@vestelbenelux.nl

www.vestelbenelux.nl

TOO Vestel Central Asia

050026 Kazakhsatan/Almaty Aiteke bi 187, office:215

Phone: 7 - 727 263 39 39**Vestel CIS Ltd.**

1-st Graivoronovsky Proezd, No.20 Building 16, 109518,

Moscow/Russia

Phone: 7 - 095 956 8230**Fax:** 7 - 095 956 8233

info@vestel.ru

www.vestel.ru

Vestel Electronica

Str Zidarului nr 9-11, Sector 5 Bucuresti, ZIP 051765

Bucharest/Romania

Phone: 40 - 31 425 42 93

Fax: 40 -31 425 42 95

office@vestel.ro

www.vestel.ro

Vestel France S.A.

17 Rue de la Couture-Silic BP 10190-94563 RUNGIS

Cedex/France

Phone: 33 - 1 46 75 00 29

Fax: 33 - 1 41 80 99 31

p.benhamou@vestel-france.fr

Vestel Germany GmbH

Parkring 6 D-85748 Garching bei München/Germany

Phone: 49 - 89 55295 - 0

Fax: 49 - 89 55295 - 2000

info@vestel-germany.de

www.vestel-germany.de

Gruppo Industriale Vesit SPA

Società Unipersonale Via Polidoro da Caravaggio, 6 20156

- Milano/Italy

Phone: 39 - 02 842 48577

Fax: 39 - 02 842 48617

info@givesit.it

www.givesit.it

Vestfrost Household

Spangsbjerg Mollevej 100, DK-6705 Esbjerg 0, Denmark

Phone: 45 - 7610 4045

Fax: 45 - 7610 4046

Vestel Iberia

Avda. Partenon, 16-18 Planta 1 Oficina 6, 28042 Madrid/

Spain

Phone: 34 - 91 320 63 98**Fax:** 34 - 91 320 52 58

vestel@vestel.es www.vestel.es

Vestel Poland

Poleczki 33, 02-822 Warszawa, Mazowieckie

Phone: 48 22 2555700

info@vestel-poland.com

Vestel Scandinavia

Phone: 358 - 50 - 5681058

Vestel UK Ltd

Vestel House, Waterside Drive

Langley, Berkshire SL3 6EZ

Phone: 44 - 3330 146 400

info@vestel-uk.com

www.vestel.co.uk

United Technical Services

S.R.O. ul. Senecká 16, 91101 Samorin, Slovakia

Phone: 421- 31 590 27 31

Fax: 421- 31 590 27 38

info@uts.sk

www.uts.sk

VESTEL

Organize Sanayi Bölgesi, 45030 Manisa/Türkiye

Phone: 90 - 236 233 25 82 **Fax:** 90 - 236 233 25 84

vesteltrade@vestel.com.tr

www.vestel.com.tr